

# CSD17571Q2 30V N-Channel NexFET™ Power MOSFETs

## 1 Features

- Low  $Q_g$  and  $Q_{gd}$
- Low Thermal Resistance
- Avalanche Rated
- Pb-Free Terminal Plating
- RoHS Compliant
- Halogen Free
- SON 2 mm x 2 mm Plastic Package

## 2 Applications

- Optimized for Load Switch Applications
- Storage, Tablets, and Handheld Devices
- Optimized for Control FET Applications

## 3 Description

This 30 V, 20 mΩ, SON 2x2 NexFET™ power MOSFET is designed to minimize losses in power conversion and load management applications, while offering excellent thermal performance for the size of the package.

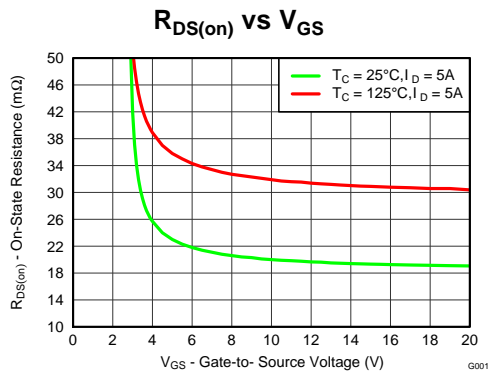
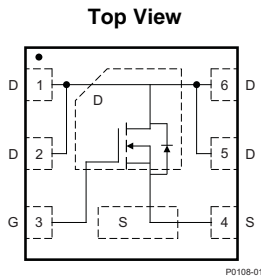

## Product Summary

$T_A = 25^\circ\text{C}$		TYPICAL VALUE		UNIT
$V_{DS}$	Drain-to-Source Voltage	30		V
$Q_g$	Gate Charge Total (4.5 V)	2.4		nC
$Q_{gd}$	Gate Charge Gate-to-Drain	0.6		nC
$R_{DS(on)}$	Drain-to-Source On-Resistance	$V_{GS} = 4.5\text{ V}$	24	mΩ
		$V_{GS} = 10\text{ V}$	20	mΩ
$V_{GS(th)}$	Threshold Voltage	1.6		V

## Ordering Information<sup>(1)</sup>

Device	Media	Qty	Package	Ship
CSD17571Q2	7-Inch Reel	3000	SON 2 x 2 mm Plastic Package	Tape and Reel

(1) For all available packages, see the orderable addendum at the end of the data sheet.

## Absolute Maximum Ratings

$T_A = 25^\circ\text{C}$		VALUE	UNIT
$V_{DS}$	Drain-to-Source Voltage	30	V
$V_{GS}$	Gate-to-Source Voltage	±20	V
$I_D$	Continuous Drain Current (Package Limit)	22	A
	Continuous Drain Current <sup>(1)</sup>	7.6	A
$I_{DM}$	Pulsed Drain Current, $T_A = 25^\circ\text{C}$ <sup>(2)</sup>	39	A
$P_D$	Power Dissipation <sup>(1)</sup>	2.5	W
$T_J, T_{stg}$	Operating Junction and Storage Temperature Range	-55 to 150	°C
$E_{AS}$	Avalanche Energy, single pulse $I_D = 12\text{ A}, L = 0.1\text{ mH}, R_G = 25\ \Omega$	7.2	mJ

(1)  $R_{\theta JA} = 50$  on 1 in<sup>2</sup> Cu (2 oz.) on 0.060" thick FR4 PCB

(2) Pulse duration 10 μs, duty cycle ≤2%

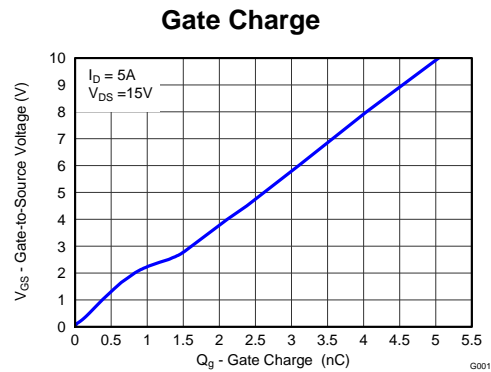

## Table of Contents

<b>1 Features</b> .....	<b>1</b>	<b>6 Device and Documentation Support</b> .....	<b>7</b>
<b>2 Applications</b> .....	<b>1</b>	6.1 Trademarks .....	7
<b>3 Description</b> .....	<b>1</b>	6.2 Electrostatic Discharge Caution .....	7
<b>4 Revision History</b> .....	<b>2</b>	6.3 Glossary .....	7
<b>5 Specifications</b> .....	<b>3</b>	<b>7 Mechanical, Packaging, and Orderable Information</b> .....	<b>8</b>
5.1 Electrical Characteristics .....	3	7.1 Q2 Package Dimensions .....	8
5.2 Thermal Information .....	3	7.2 Q2 Tape and Reel Information .....	10
5.3 Typical MOSFET Characteristics .....	4		

## 4 Revision History

### Changes from Original (October 2013) to Revision A

**Page**

• Updated Figure #8 .....	<b>6</b>
---------------------------	----------

## 5 Specifications

### 5.1 Electrical Characteristics

 $T_A = 25^\circ\text{C}$ 

PARAMETER		TEST CONDITIONS	MIN	TYP	MAX	UNIT
<b>STATIC CHARACTERISTICS</b>						
$BV_{DSS}$	Drain-to-Source Voltage	$V_{GS} = 0\text{ V}, I_D = 250\ \mu\text{A}$	30			V
$I_{DSS}$	Drain-to-Source Leakage Current	$V_{GS} = 0\text{ V}, V_{DS} = 24\text{ V}$			1	$\mu\text{A}$
$I_{GSS}$	Gate-to-Source Leakage Current	$V_{DS} = 0\text{ V}, V_{GS} = 20\text{ V}$			100	nA
$V_{GS(th)}$	Gate-to-Source Threshold Voltage	$V_{DS} = V_{GS}, I_{DS} = 250\ \mu\text{A}$	1.3	1.6	2	V
$R_{DS(on)}$	Drain-to-Source On-Resistance	$V_{GS} = 4.5\text{ V}, I_{DS} = 5\text{ A}$		24	29	m $\Omega$
		$V_{GS} = 10\text{ V}, I_{DS} = 5\text{ A}$		20	24	m $\Omega$
$g_{fs}$	Transconductance	$V_{DS} = 15\text{ V}, I_{DS} = 5\text{ A}$		43		S
<b>DYNAMIC CHARACTERISTICS</b>						
$C_{ISS}$	Input Capacitance	$V_{GS} = 0\text{ V}, V_{DS} = 15\text{ V}, f = 1\text{ MHz}$		360	468	pF
$C_{OSS}$	Output Capacitance			101	131	pF
$C_{RSS}$	Reverse Transfer Capacitance			9	12	pF
$R_g$	Series Gate Resistance		3.8	7.6		$\Omega$
$Q_g$	Gate Charge Total (4.5 V)	$V_{DS} = 15\text{ V}, I_{DS} = 5\text{ A}$		2.4	3.1	nC
$Q_{gd}$	Gate Charge – Gate-to-Drain			0.6		nC
$Q_{gs}$	Gate Charge Gate-to-Source			0.9		nC
$Q_{g(th)}$	Gate Charge at $V_{th}$			0.6		nC
$Q_{OSS}$	Output Charge	$V_{DS} = 15\text{ V}, V_{GS} = 0\text{ V}$		3.4		nC
$t_{d(on)}$	Turn On Delay Time	$V_{DS} = 15\text{ V}, V_{GS} = 4.5\text{ V}, I_{DS} = 5\text{ A}$ $R_G = 2\ \Omega$		5.3		ns
$t_r$	Rise Time			19		ns
$t_{d(off)}$	Turn Off Delay Time			8		ns
$t_f$	Fall Time			2.6		ns
<b>DIODE CHARACTERISTICS</b>						
$V_{SD}$	Diode Forward Voltage	$I_{DS} = 5\text{ A}, V_{GS} = 0\text{ V}$		0.8	1	V
$Q_{rr}$	Reverse Recovery Charge	$V_{DD} = 15\text{ V}, I_F = 5\text{ A}, di/dt = 300\text{ A}/\mu\text{s}$		2.3		nC
$t_{rr}$	Reverse Recovery Time				11	

### 5.2 Thermal Information

 $T_A = 25^\circ\text{C}$  unless otherwise specified

THERMAL METRIC		MIN	TYP	MAX	UNIT
$R_{\theta JC}$	Junction-to-Case Thermal Resistance <sup>(1)</sup>			6.2	$^\circ\text{C}/\text{W}$
$R_{\theta JA}$	Junction-to-Ambient Thermal Resistance <sup>(1)(2)</sup>			65	

- (1)  $R_{\theta JC}$  is determined with the device mounted on a 1 inch<sup>2</sup> (6.45 cm<sup>2</sup>), 2 oz. (0.071 mm thick) Cu pad on a 1.5 inches x 1.5 inches (3.81 cm x 3.81 cm), 0.06 inch (1.52 mm) thick FR4 PCB.  $R_{\theta JC}$  is specified by design, whereas  $R_{\theta JA}$  is determined by the user's board design.
- (2) Device mounted on FR4 material with 1 inch<sup>2</sup> (6.45 cm<sup>2</sup>), 2 oz. (0.071 mm thick) Cu.

CSD17571Q2

SLPS393A –OCTOBER 2013–REVISED JANUARY 2015

www.ti.com

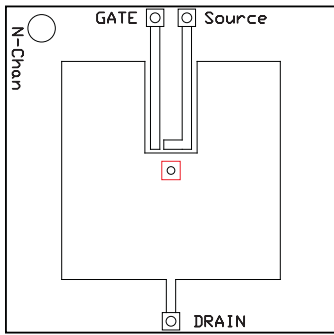

M0164-01

Max  $R_{\theta JA} = 65$  when mounted on 1 inch<sup>2</sup> (6.45 cm<sup>2</sup>) of 2 oz. (0.071 mm thick) Cu.

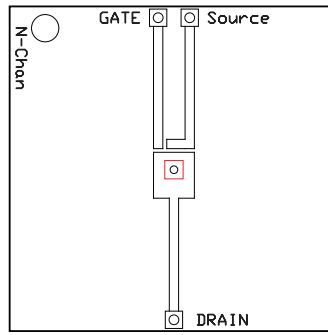

M0164-02

Max  $R_{\theta JA} = 235$  when mounted on minimum pad area of 2 oz. (0.071 mm thick) Cu.

5.3 Typical MOSFET Characteristics

$T_A = 25^\circ\text{C}$  unless otherwise specified

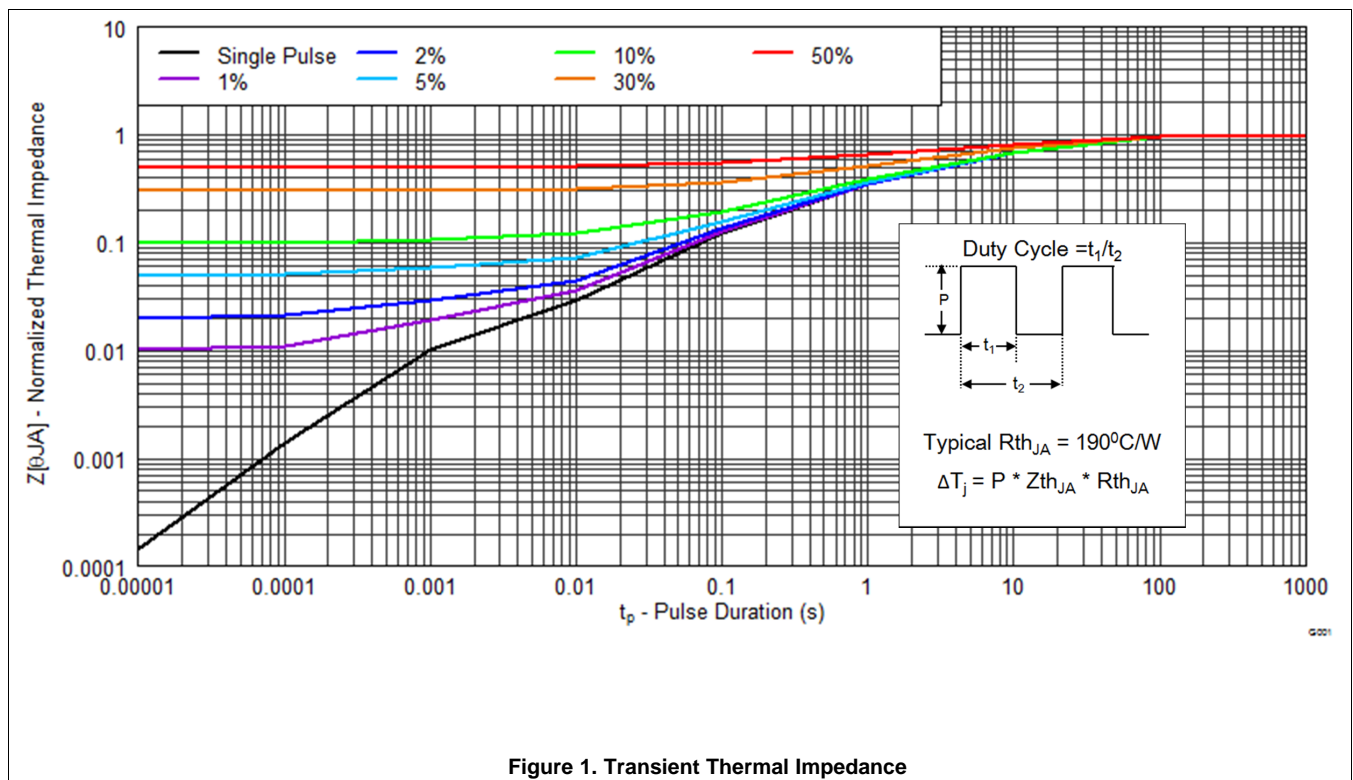

Figure 1. Transient Thermal Impedance

Typical MOSFET Characteristics (continued)

T<sub>A</sub> = 25°C unless otherwise specified

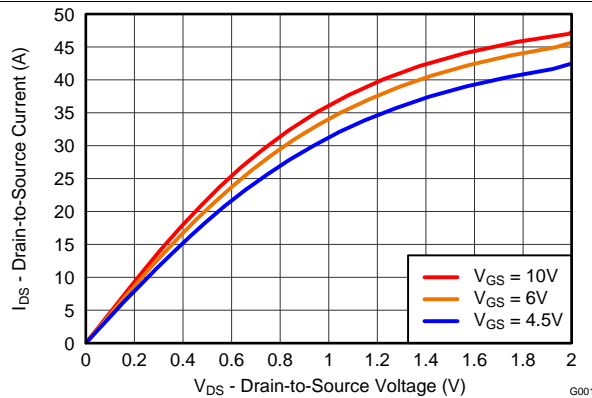

Figure 2. Saturation Characteristics

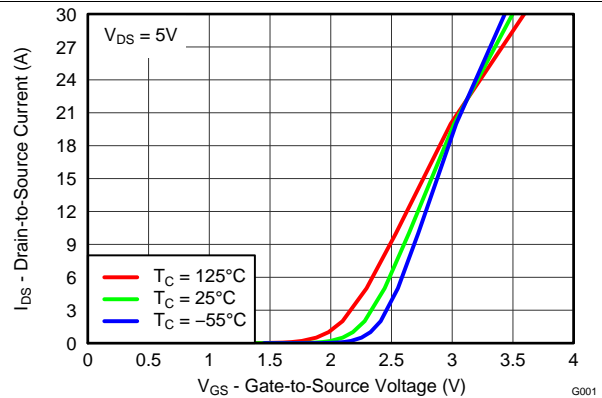

Figure 3. Transfer Characteristics

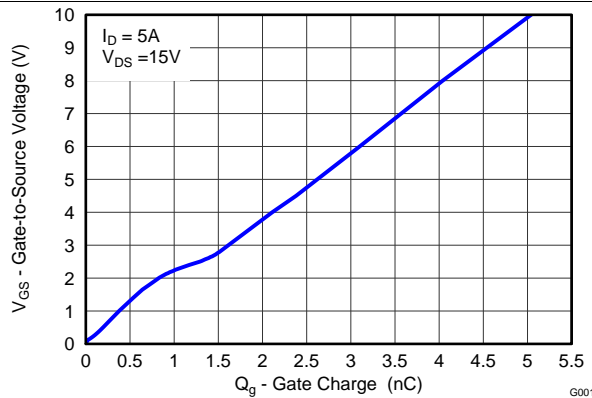

Figure 4. Gate Charge

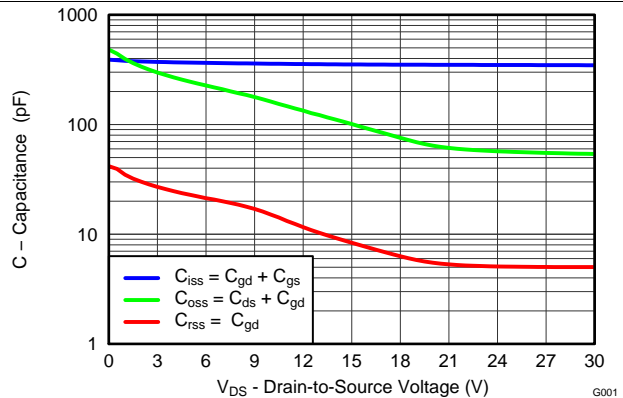

Figure 5. Capacitance

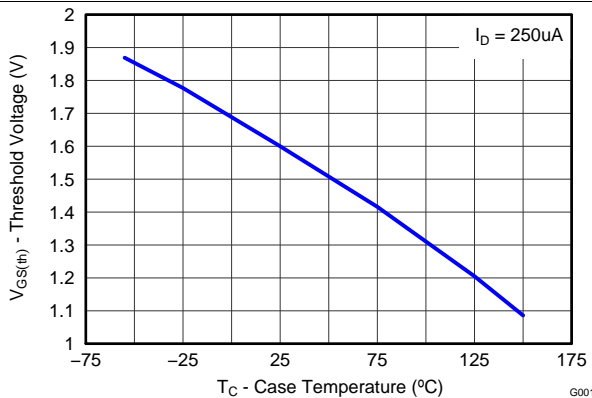

Figure 6. Threshold Voltage vs Temperature

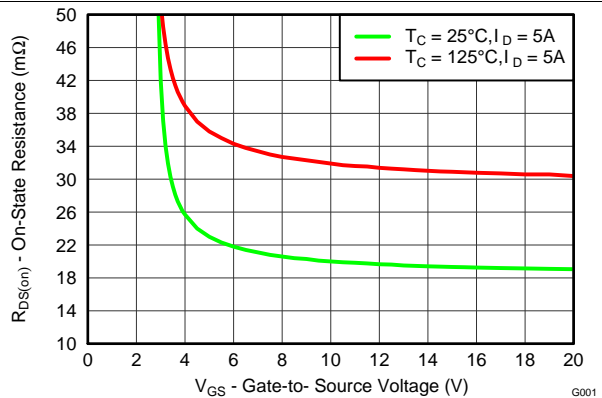

Figure 7. On-State Resistance vs Gate-to-Source Voltage

Typical MOSFET Characteristics (continued)

T<sub>A</sub> = 25°C unless otherwise specified

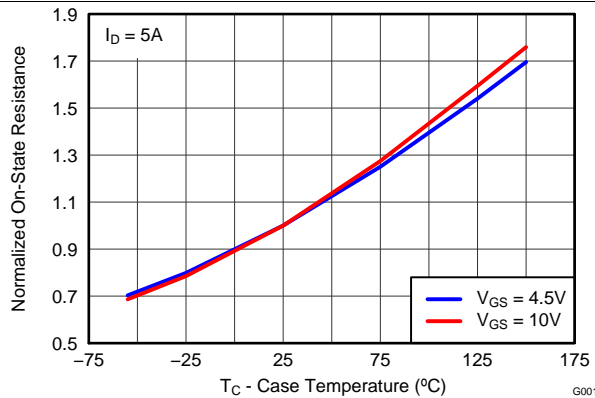

Figure 8. Normalized On-State Resistance vs Temperature

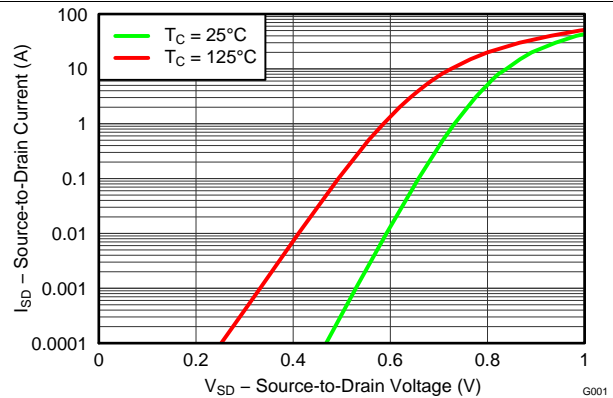

Figure 9. Typical Diode Forward Voltage

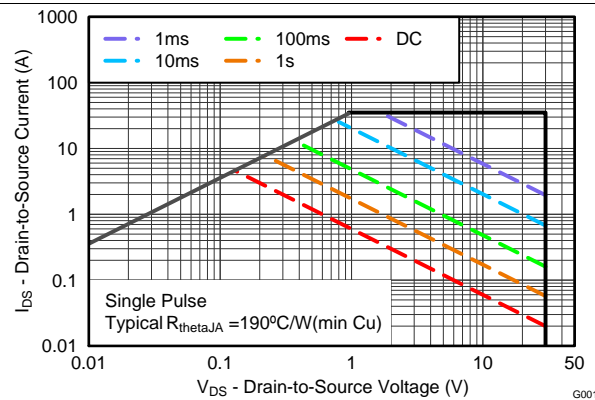

Figure 10. Maximum Safe Operating Area

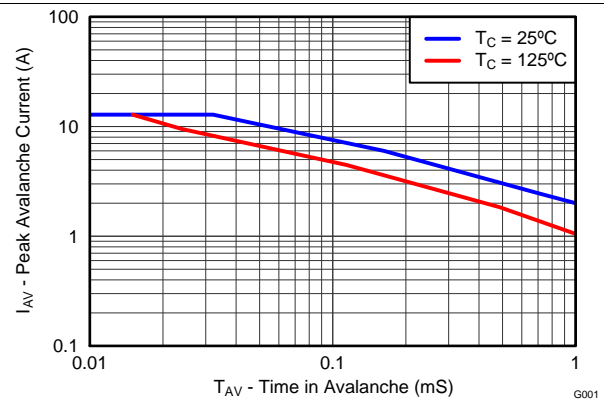

Figure 11. Single Pulse Unclamped Inductive Switching

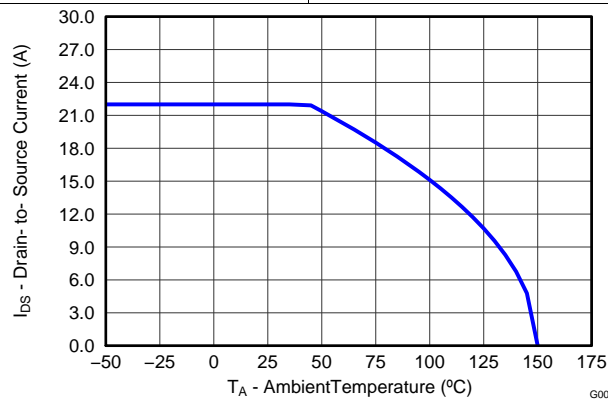

Figure 12. Maximum Drain Current vs Temperature

## 6 Device and Documentation Support

### 6.1 Trademarks

NexFET is a trademark of Texas Instruments.  
All other trademarks are the property of their respective owners.

### 6.2 Electrostatic Discharge Caution



These devices have limited built-in ESD protection. The leads should be shorted together or the device placed in conductive foam during storage or handling to prevent electrostatic damage to the MOS gates.

### 6.3 Glossary

[SLYZ022](#) — *TI Glossary*.

This glossary lists and explains terms, acronyms, and definitions.

## 7 Mechanical, Packaging, and Orderable Information

The following pages include mechanical, packaging, and orderable information. This information is the most current data available for the designated devices. This data is subject to change without notice and revision of this document. For browser-based versions of this data sheet, refer to the left-hand navigation.

### 7.1 Q2 Package Dimensions

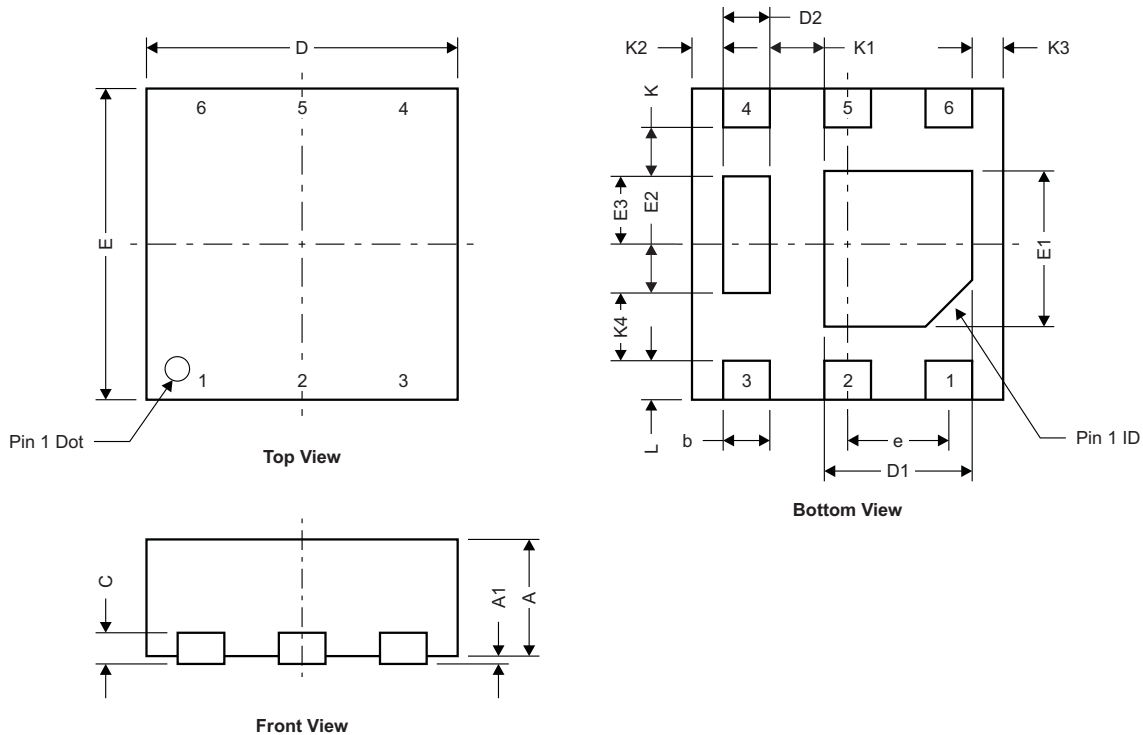

M0165-01

DIM	MILLIMETERS			INCHES		
	MIN	NOM	MAX	MIN	NOM	MAX
A	0.700	0.750	0.800	0.028	0.030	0.032
A1	0.000		0.050	0.000		0.002
b	0.250	0.300	0.350	0.010	0.012	0.014
C		0.203 TYP			0.008 TYP	
D		2.000 TYP			0.080 TYP	
D1	0.900	0.950	1.000	0.036	0.038	0.040
D2		0.300 TYP			0.012 TYP	
E		2.000 TYP			0.080 TYP	
E1	0.900	1.000	1.100	0.036	0.040	0.044
E2		0.280 TYP			0.0112 TYP	
E3		0.470 TYP			0.0188 TYP	
e		0.650 BSC			0.026 TYP	
K		0.280 TYP			0.0112 TYP	
K1		0.350 TYP			0.014 TYP	
K2		0.200 TYP			0.008 TYP	
K3		0.200 TYP			0.008 TYP	
K4		0.470 TYP			0.0188 TYP	
L	0.200	0.25	0.300	0.008	0.010	0.012



7.1.1 Recommended PCB Pattern

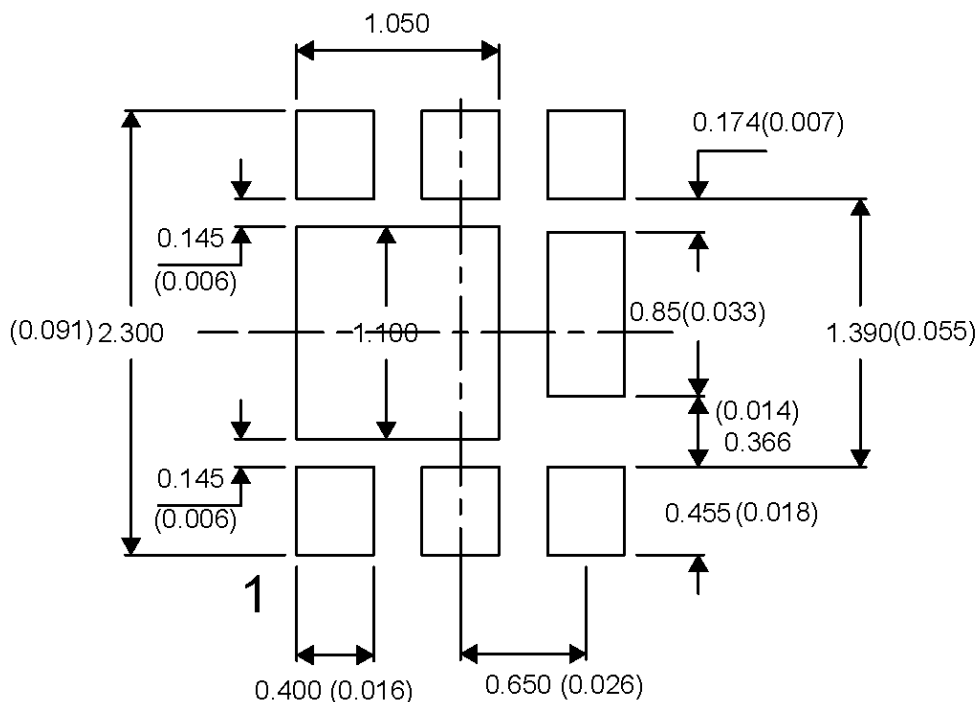

For recommended circuit layout for PCB designs, see application note [SLPA005 – Reducing Ringing Through PCB Layout Techniques](#).

7.1.2 Recommended Stencil Pattern

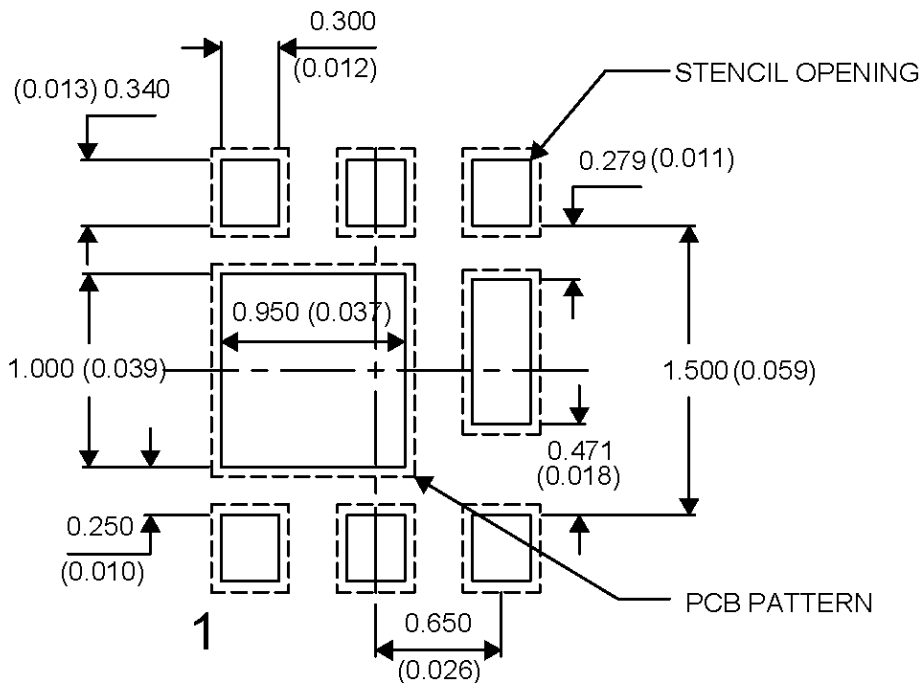

Note: All dimensions are in mm, unless otherwise specified.

## 7.2 Q2 Tape and Reel Information

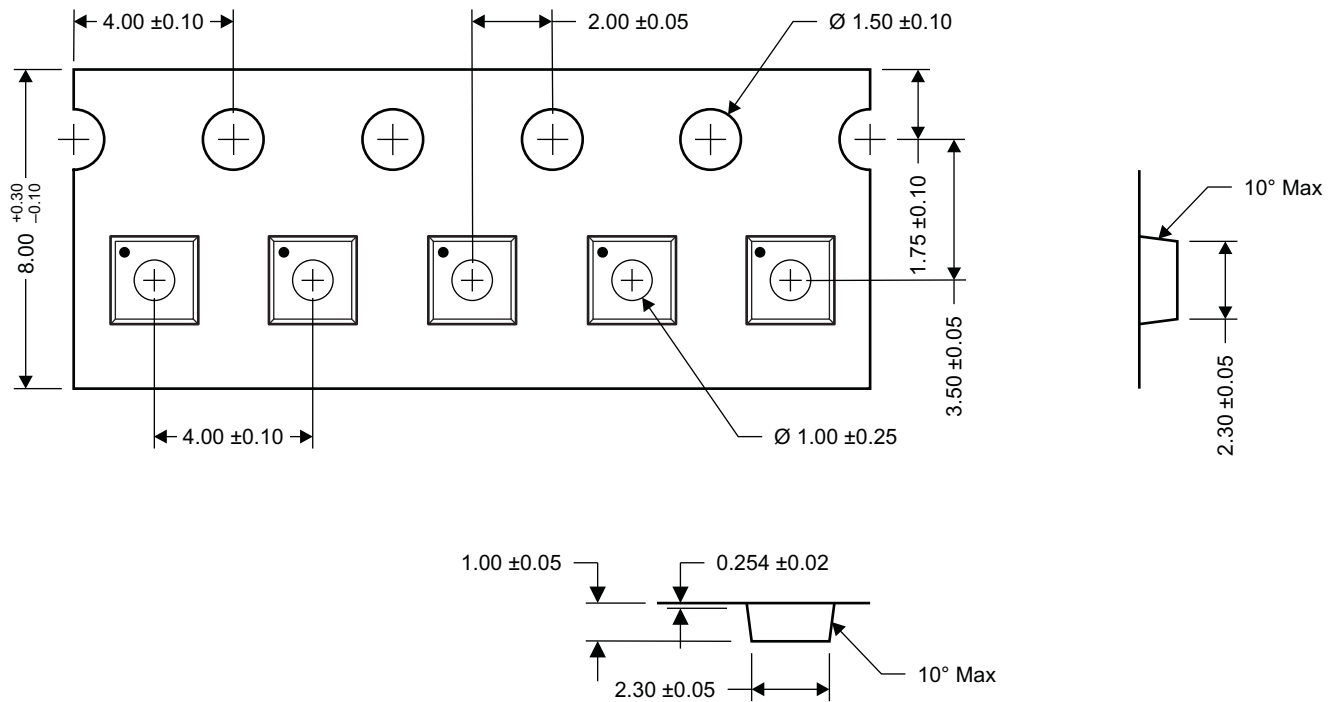

- Notes:
1. Measured from centerline of sprocket hole to centerline of pocket
  2. Cumulative tolerance of 10 sprocket holes is  $\pm 0.20$
  3. Other material available
  4. Typical SR of form tape Max  $10^9$  OHM/SQ
  5. All dimensions are in mm, unless otherwise specified.

M0168-01

**PACKAGING INFORMATION**

Orderable Device	Status (1)	Package Type	Package Drawing	Pins	Package Qty	Eco Plan (2)	Lead/Ball Finish (6)	MSL Peak Temp (3)	Op Temp (°C)	Device Marking (4/5)	Samples
CSD17571Q2	ACTIVE	WSON	DQK	6	3000	Green (RoHS & no Sb/Br)	NIPDAU   SN	Level-1-260C-UNLIM	-55 to 150	1751	<a href="#">Samples</a>

(1) The marketing status values are defined as follows:

**ACTIVE:** Product device recommended for new designs.

**LIFEBUY:** TI has announced that the device will be discontinued, and a lifetime-buy period is in effect.

**NRND:** Not recommended for new designs. Device is in production to support existing customers, but TI does not recommend using this part in a new design.

**PREVIEW:** Device has been announced but is not in production. Samples may or may not be available.

**OBSOLETE:** TI has discontinued the production of the device.

(2) **RoHS:** TI defines "RoHS" to mean semiconductor products that are compliant with the current EU RoHS requirements for all 10 RoHS substances, including the requirement that RoHS substance do not exceed 0.1% by weight in homogeneous materials. Where designed to be soldered at high temperatures, "RoHS" products are suitable for use in specified lead-free processes. TI may reference these types of products as "Pb-Free".

**RoHS Exempt:** TI defines "RoHS Exempt" to mean products that contain lead but are compliant with EU RoHS pursuant to a specific EU RoHS exemption.

**Green:** TI defines "Green" to mean the content of Chlorine (Cl) and Bromine (Br) based flame retardants meet JS709B low halogen requirements of <=1000ppm threshold. Antimony trioxide based flame retardants must also meet the <=1000ppm threshold requirement.

(3) MSL, Peak Temp. - The Moisture Sensitivity Level rating according to the JEDEC industry standard classifications, and peak solder temperature.

(4) There may be additional marking, which relates to the logo, the lot trace code information, or the environmental category on the device.

(5) Multiple Device Markings will be inside parentheses. Only one Device Marking contained in parentheses and separated by a "~" will appear on a device. If a line is indented then it is a continuation of the previous line and the two combined represent the entire Device Marking for that device.

(6) Lead/Ball Finish - Orderable Devices may have multiple material finish options. Finish options are separated by a vertical ruled line. Lead/Ball Finish values may wrap to two lines if the finish value exceeds the maximum column width.

**Important Information and Disclaimer:**The information provided on this page represents TI's knowledge and belief as of the date that it is provided. TI bases its knowledge and belief on information provided by third parties, and makes no representation or warranty as to the accuracy of such information. Efforts are underway to better integrate information from third parties. TI has taken and continues to take reasonable steps to provide representative and accurate information but may not have conducted destructive testing or chemical analysis on incoming materials and chemicals. TI and TI suppliers consider certain information to be proprietary, and thus CAS numbers and other limited information may not be available for release.

In no event shall TI's liability arising out of such information exceed the total purchase price of the TI part(s) at issue in this document sold by TI to Customer on an annual basis.

## IMPORTANT NOTICE AND DISCLAIMER

TI PROVIDES TECHNICAL AND RELIABILITY DATA (INCLUDING DATASHEETS), DESIGN RESOURCES (INCLUDING REFERENCE DESIGNS), APPLICATION OR OTHER DESIGN ADVICE, WEB TOOLS, SAFETY INFORMATION, AND OTHER RESOURCES "AS IS" AND WITH ALL FAULTS, AND DISCLAIMS ALL WARRANTIES, EXPRESS AND IMPLIED, INCLUDING WITHOUT LIMITATION ANY IMPLIED WARRANTIES OF MERCHANTABILITY, FITNESS FOR A PARTICULAR PURPOSE OR NON-INFRINGEMENT OF THIRD PARTY INTELLECTUAL PROPERTY RIGHTS.

These resources are intended for skilled developers designing with TI products. You are solely responsible for (1) selecting the appropriate TI products for your application, (2) designing, validating and testing your application, and (3) ensuring your application meets applicable standards, and any other safety, security, or other requirements. These resources are subject to change without notice. TI grants you permission to use these resources only for development of an application that uses the TI products described in the resource. Other reproduction and display of these resources is prohibited. No license is granted to any other TI intellectual property right or to any third party intellectual property right. TI disclaims responsibility for, and you will fully indemnify TI and its representatives against, any claims, damages, costs, losses, and liabilities arising out of your use of these resources.

TI's products are provided subject to TI's Terms of Sale ([www.ti.com/legal/termsofsale.html](http://www.ti.com/legal/termsofsale.html)) or other applicable terms available either on [ti.com](http://ti.com) or provided in conjunction with such TI products. TI's provision of these resources does not expand or otherwise alter TI's applicable warranties or warranty disclaimers for TI products.

Mailing Address: Texas Instruments, Post Office Box 655303, Dallas, Texas 75265  
Copyright © 2020, Texas Instruments Incorporated