

# Manganese Dioxide Lithium Coin Batteries: Individual Specifications

## CR2354

### ☒ Dimensions(mm)

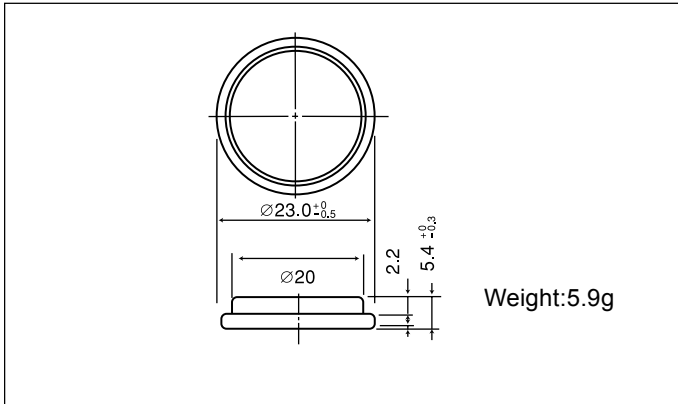

### ☒ Specification

<b>Nominal voltage (V)</b>	3
<b>Nominal capacity (mAh)</b>	560
<b>Continuous standard load (mA)</b>	0.2
<b>Operating temperature (C)</b>	-30 ~ +60

### ☒ Temperature Characteristics

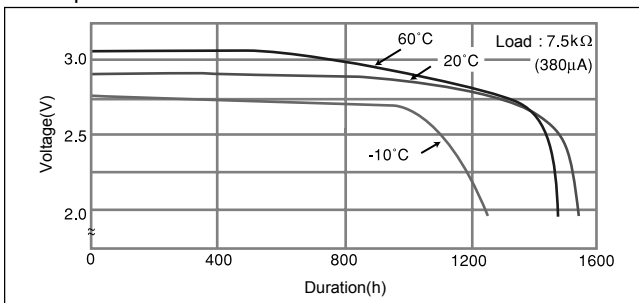

### ☒ Operating voltage vs. load resistance(voltage at 50% discharge depth)

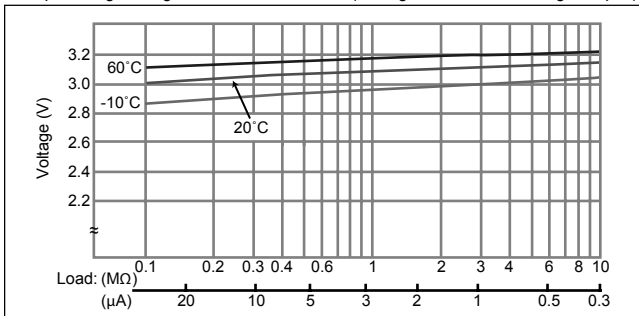

### ☒ Capacity vs. load resistance

