

Surface Mount

# Monolithic Amplifier

DC-4 GHz

## Product Features

- DC-4 GHz
- Single Voltage Supply
- Internally Matched to 50 Ohms
- Unconditionally Stable
- Low Performance Variation Over Temperature
- Transient Protected
- Aqueous washable
- Protected By US Patent 6,943,629

## Typical Applications

- Cellular/ PCS/ 3G Base Station
- CATV, Cable Modem & DBS
- Fixed Wireless & WLAN
- Microwave Radio & Test Equipment



Generic photo used for illustration purposes only

## ERA-51SM+

CASE STYLE: WW107

**+RoHS Compliant**

The +Suffix identifies RoHS Compliance. See our web site for RoHS Compliance methodologies and qualifications

## General Description

ERA-51SM+ (RoHS compliant) is a wideband amplifier offering high dynamic range. It has repeatable performance from lot to lot. It is enclosed in an Micro-X package. ERA-51SM+ uses Darlington configuration and is fabricated using InGaP HBT technology. Expected MTTF is 450 years at 85°C case temperature.

## simplified schematic and pin description

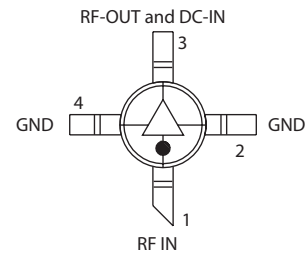
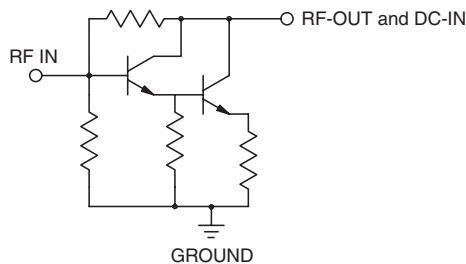

Function	Pin Number	Description
RF IN	1	RF input pin. This pin requires the use of an external DC blocking capacitor chosen for the frequency of operation.
RF-OUT and DC-IN	3	RF output and bias pin. DC voltage is present on this pin; therefore a DC blocking capacitor is necessary for proper operation. An RF choke is needed to feed DC bias without loss of RF signal due to the bias connection, as shown in "Recommended Application Circuit".
GND	2,4	Connections to ground. Use via holes as shown in "Suggested Layout for PCB Design" to reduce ground path inductance for best performance.

### Notes

- Performance and quality attributes and conditions not expressly stated in this specification document are intended to be excluded and do not form a part of this specification document.
- Electrical specifications and performance data contained in this specification document are based on Mini-Circuit's applicable established test performance criteria and measurement instructions.
- The parts covered by this specification document are subject to Mini-Circuits standard limited warranty and terms and conditions (collectively, "Standard Terms"); Purchasers of this part are entitled to the rights and benefits contained therein. For a full statement of the Standard Terms and the exclusive rights and remedies thereunder, please visit Mini-Circuits' website at [www.minicircuits.com/MCLStore/terms.jsp](http://www.minicircuits.com/MCLStore/terms.jsp)



Electrical Specifications at 25°C and 65mA, unless noted

Parameter		Min.	Typ.	Max.	Units	Cpk
Frequency Range*		DC		4	GHz	
Gain	f=0.1 GHz	17	18	19	dB	≥ 1.5
	f=1 GHz	—	17.4	—		
	f=2 GHz	14	16.1	17.2		
	f=3 GHz	—	14.8	—		
	f=4 GHz	11.5	12.5	14.5		
Magnitude of Gain Variation versus Temperature (values are negative)	f=0.1 GHz	—	.0012	.0024	dB/°C	
	f=1 GHz	—	.002	.004		
	f=2 GHz	—	.0027	.0054		
	f=3 GHz	—	.0033	.0066		
	f=4 GHz	—	.0043	.0086		
Input Return Loss	f=0.1 GHz		26		dB	
	f=1 GHz		29			
	f=2 GHz		32			
	f=3 GHz		28			
	f=4 GHz		25			
Output Return Loss	f=0.1 GHz		28		dB	
	f=1 GHz		24			
	f=2 GHz		21			
	f=3 GHz		24			
	f=4 GHz		21			
Reverse Isolation	f=1.0 GHz	19	22	—	dB	
Output Power @ 1 dB compression	f=0.1 GHz	—	18.3	—	dBm	≥ 1.33
	f=1 GHz	16.5	18.1	—		
	f=2 GHz	—	17.8	—		
	f=3 GHz	—	16.9	—		
	f=4 GHz	—	14.8	—		
Saturated Output Power (at 3dB compression)	f=0.1 GHz		18		dBm	
	f=1 GHz		18			
	f=2 GHz		18			
	f=3 GHz		17			
	f=4 GHz		16			
Output IP3	f=0.1 GHz	33.5	35.1	—	dBm	≥ 1.33
	f=1 GHz	—	35.4	—		
	f=2 GHz	31	33.9	—		
	f=3 GHz	—	31	—		
	f=4 GHz	25	27.8	—		
Noise Figure	f=0.1 GHz	—	3.6	4.2	dB	≥ 1.33
	f=1GHz	—	3.7	—		
	f=2 GHz	—	3.7	4.5		
	f=3 GHz	—	3.9	—		
	f=4 GHz	—	4	5		
Group Delay	f=1 GHz		100		psec	
Recommended Device Operating Current			65		mA	
Device Operating Voltage		4.2	4.5	4.8	V	≥ 1.5
Device Voltage Variation vs. Temperature at 65mA			-3.2		mV/°C	
Device Voltage Variation vs. Current at 25°C			5.8		mV/mA	
Thermal Resistance, junction-to-case <sup>1</sup>			154		°C/W	

\*Guaranteed specification DC-4 GHz. Low frequency cut off determined by external coupling capacitors.

Absolute Maximum Ratings

Parameter	Ratings
Operating Temperature*	-45°C to 85°C
Storage Temperature	-65°C to 150°C
Operating Current	85mA
Power Dissipation	451mW
Input Power	13dBm

Note: Permanent damage may occur if any of these limits are exceeded. These ratings are not intended for continuous normal operation.

<sup>1</sup>Case is defined as ground leads.

\*Based on typical case temperature rise 5°C above ambient.

Notes

- A. Performance and quality attributes and conditions not expressly stated in this specification document are intended to be excluded and do not form a part of this specification document.
- B. Electrical specifications and performance data contained in this specification document are based on Mini-Circuit's applicable established test performance criteria and measurement instructions.
- C. The parts covered by this specification document are subject to Mini-Circuits standard limited warranty and terms and conditions (collectively, "Standard Terms"); Purchasers of this part are entitled to the rights and benefits contained therein. For a full statement of the Standard Terms and the exclusive rights and remedies thereunder, please visit Mini-Circuits' website at [www.minicircuits.com/MCLStore/terms.jsp](http://www.minicircuits.com/MCLStore/terms.jsp)



Product Marking

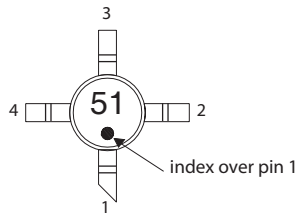

Markings in addition to model number designation may appear for internal quality control purposes.

Additional Detailed Technical Information

Additional information is available on our web site. To access this information enter the model number on our web site home page.

Performance data, graphs, s-parameter data set (.zip file)

Case Style: WW107

Plastic micro-x, .085 body diameter, lead finish: Matte-Tin

Tape & Reel: F4

7" Reels with 20, 50, 100, 200, 500, 1K devices

Suggested Layout for PCB Design: PL-075

Evaluation Board: TB-408-51+

Environmental Ratings: ENV08T2

Recommended Application Circuit

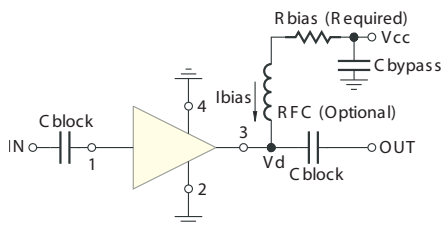

Test Board includes case, connectors, and components (in bold) soldered to PCB

R BIAS	
Vcc	"1%" Res. Values (ohms) for Optimum Biasing
7	40.2
8	53.6
9	68.1
10	82.5
11	97.6
12	113
13	127
14	143
15	158
16	174
17	191
18	205
19	221
20	237

Notes

- A. Performance and quality attributes and conditions not expressly stated in this specification document are intended to be excluded and do not form a part of this specification document.
- B. Electrical specifications and performance data contained in this specification document are based on Mini-Circuit's applicable established test performance criteria and measurement instructions.
- C. The parts covered by this specification document are subject to Mini-Circuits standard limited warranty and terms and conditions (collectively, "Standard Terms"); Purchasers of this part are entitled to the rights and benefits contained therein. For a full statement of the Standard Terms and the exclusive rights and remedies thereunder, please visit Mini-Circuits' website at [www.minicircuits.com/MCLStore/terms.jsp](http://www.minicircuits.com/MCLStore/terms.jsp)



**ESD Rating**

Human Body Model (HBM): Class 1B (500 v to < 1000 v) in accordance with ANSI/ESD STM 5.1 - 2001

Machine Model (MM): Class M1 (< 100 v) in accordance with ANSI/ESD STM 5.2 - 1999

**MSL Rating**

Moisture Sensitivity: MSL1 in accordance with IPC/JEDECJ-STD-020C

No.	Test Required	Condition	Standard	Quantity
1	Visual Inspection	Low Power Microscope Magnification 40x	MIP-IN-0003 (MCT spec)	45 units
2	Electrical Test	Room Temperature	SCD (MCL spec)	45 units
3	SAM Analysis	Less than 10% growth in term of delamination	J-Std-020C (Jedec Standard)	45 units
4	Moisture Sensitivity Level 1	Bake at 125°C for 24 hours Soak at 85°C/85%RH for 168 hours Reflow 3 cycles at 260°C peak	J-Std-020C (Jedec Standard)	45 units

**MSL Test Flow Chart**

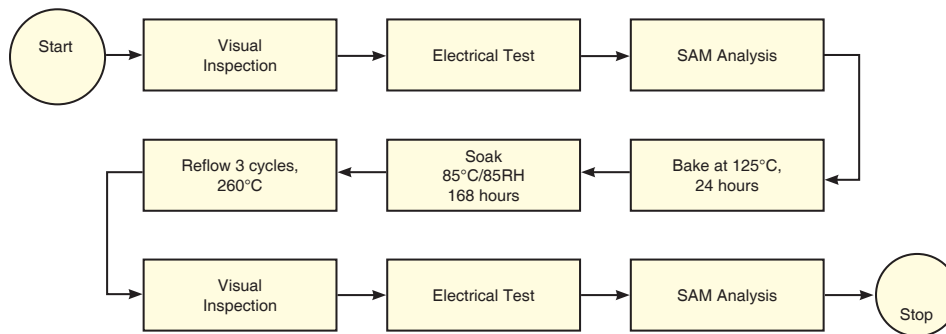

**Notes**

- A. Performance and quality attributes and conditions not expressly stated in this specification document are intended to be excluded and do not form a part of this specification document.
- B. Electrical specifications and performance data contained in this specification document are based on Mini-Circuit's applicable established test performance criteria and measurement instructions.
- C. The parts covered by this specification document are subject to Mini-Circuits standard limited warranty and terms and conditions (collectively, "Standard Terms"); Purchasers of this part are entitled to the rights and benefits contained therein. For a full statement of the Standard Terms and the exclusive rights and remedies thereunder, please visit Mini-Circuits' website at [www.minicircuits.com/MCLStore/terms.jsp](http://www.minicircuits.com/MCLStore/terms.jsp)



# MMIC Amplifier

# ERA-51SM+

## Typical Performance Data

**NOTE: Use PDF Bookmarks to view DATA at required conditions.**

### Definitions:

Input Return Loss = -S11 (dB)

Gain(Power Gain) = S21 (dB)

Reverse Isolation = -S12 (dB)

Output Return Loss = -S22 (dB)

TEST CONDITIONS: Icc = 65mA, Vd = 4.44V @Temperature = +25degC

FREQ	Gain	Isolation	Input Return Loss	Output Return Loss	Stability		IP3 Output	1dB Comp. Output	Noise Figure
					K	Delta			
(MHz)	(dB)	(dB)	(dB)	(dB)	K	Delta	(dBm)	(dBm)	(dB)
50	17.81	20.79	24.67	42.04	1.06	0.71	36.18	18.43	3.06
100	17.77	20.38	24.96	45.28	1.04	0.74	36.05	18.35	3.22
200	17.74	20.43	25.67	41.08	1.05	0.73	36.93	18.40	3.14
300	17.67	20.38	24.73	37.20	1.05	0.73	37.32	18.34	3.17
400	17.63	20.42	25.02	33.55	1.05	0.73	36.84	18.28	3.14
500	17.58	20.43	24.28	31.54	1.05	0.72	36.33	18.24	3.20
600	17.50	20.44	23.62	29.51	1.06	0.71	36.24	18.16	3.18
700	17.43	20.44	23.13	28.23	1.06	0.71	36.35	18.06	3.21
800	17.36	20.44	22.31	27.17	1.06	0.71	36.17	17.89	3.21
900	17.28	20.42	22.03	26.13	1.06	0.70	36.07	17.80	3.15
1000	17.19	20.42	21.79	25.05	1.07	0.69	35.58	17.71	3.14
1100	17.09	20.45	21.32	23.89	1.07	0.68	35.34	17.74	3.13
1200	17.00	20.44	20.99	23.22	1.08	0.68	35.16	17.66	3.16
1300	16.88	20.41	20.99	22.53	1.08	0.67	34.77	17.70	3.19
1400	16.78	20.41	20.81	21.65	1.08	0.67	34.49	17.68	3.07
1500	16.66	20.41	20.47	20.94	1.09	0.66	34.66	17.58	3.15
1600	16.55	20.35	20.34	20.32	1.09	0.65	35.26	17.54	3.16
1700	16.43	20.30	20.35	19.79	1.09	0.65	34.87	17.48	3.14
1800	16.32	20.32	20.24	19.37	1.10	0.64	34.17	17.51	3.12
1900	16.20	20.31	20.35	18.98	1.11	0.63	33.59	17.51	3.18
2000	16.08	20.20	20.53	18.49	1.11	0.63	33.14	17.52	3.15
2100	15.94	20.28	20.57	18.11	1.12	0.62	32.76	17.38	3.14
2200	15.83	20.24	20.83	17.74	1.12	0.61	32.44	17.22	3.15
2300	15.71	20.13	20.82	17.41	1.12	0.61	32.12	16.97	3.16
2400	15.56	20.13	20.93	16.91	1.13	0.60	31.73	16.83	3.19
2500	15.42	20.13	21.02	16.55	1.14	0.59	31.27	16.69	3.26
2600	15.31	20.07	21.47	16.46	1.14	0.59	30.95	16.47	3.21
2700	15.19	19.99	21.70	16.09	1.14	0.59	30.48	16.13	3.18
2800	15.04	20.01	21.98	15.75	1.15	0.57	29.99	16.17	3.24
2900	14.93	19.99	22.69	15.60	1.15	0.57	29.72	15.80	3.20
3000	14.80	19.88	23.17	15.23	1.15	0.56	29.40	15.62	3.17
3100	14.65	19.88	23.39	14.97	1.16	0.56	28.99	15.01	3.24
3200	14.53	19.88	23.83	14.81	1.17	0.55	28.58	15.01	3.23
3300	14.45	19.74	24.66	14.47	1.16	0.55	28.10	14.84	3.29
3400	14.29	19.73	25.38	14.22	1.17	0.54	27.71	14.47	3.31
3500	14.17	19.68	25.74	14.10	1.17	0.54	27.40	14.35	3.33
3600	14.07	19.57	26.98	13.80	1.17	0.54	27.14	14.21	3.32
3700	13.91	19.53	27.70	13.69	1.18	0.53	26.87	14.28	3.38
3800	13.81	19.46	28.41	13.48	1.18	0.52	26.53	13.74	3.37
4000	13.60	19.28	32.63	12.90	1.17	0.52	25.70	13.31	3.24

REV. X1  
ERA-51SM+  
070907  
Page 1 of 11



IF/RF MICROWAVE COMPONENTS • ISO 9001 ISO 14001 AS 9100 CERTIFIED • RoHS compliant

P.O. Box 350166, Brooklyn, New York 11235-0003 (718) 934-4500 Fax (718) 332-4661



The Design Engineers Search Engine finds the model you need, Instantly • For detailed performance specs & shopping online see



# MMIC Amplifier

# ERA-51SM+

## Typical Performance Data

### Definitions:

Input Return Loss = -S11 (dB)

Gain(Power Gain) = S21 (dB)

Reverse Isolation = -S12 (dB)

Output Return Loss = -S22 (dB)

TEST CONDITIONS: Icc = 52mA, Vd = 4.36V @Temperature = +25degC

FREQ	Gain	Isolation	Input Return Loss	Output Return Loss	Stability		IP3 Output	1dB Comp. Output	Noise Figure
					K	Delta			
(MHz)	(dB)	(dB)	(dB)	(dB)	K	Delta	(dBm)	(dBm)	(dB)
50	17.63	20.05	27.25	35.17	1.04	0.76	32.01	16.43	3.01
100	17.59	20.15	28.65	33.84	1.04	0.74	31.77	16.15	3.15
200	17.56	20.27	28.55	34.96	1.05	0.73	32.19	16.34	3.08
300	17.49	20.24	27.06	33.26	1.05	0.73	32.37	16.29	3.12
400	17.45	20.28	27.74	32.05	1.05	0.72	31.99	16.30	3.10
500	17.40	20.36	26.25	30.16	1.06	0.71	31.72	16.30	3.13
600	17.34	20.26	25.24	28.50	1.06	0.72	31.66	16.07	3.15
700	17.26	20.26	24.51	27.81	1.06	0.71	31.90	15.95	3.15
800	17.18	20.25	23.49	26.66	1.06	0.70	31.88	15.62	3.16
900	17.12	20.27	23.19	25.97	1.06	0.70	31.78	15.65	3.09
1000	17.02	20.28	22.73	24.95	1.07	0.69	31.52	15.49	3.11
1100	16.92	20.28	22.21	23.92	1.07	0.68	31.47	15.69	3.06
1200	16.84	20.25	21.80	23.19	1.08	0.68	31.47	15.54	3.11
1300	16.72	20.26	21.78	22.51	1.08	0.67	31.30	15.58	3.13
1400	16.61	20.24	21.54	21.63	1.08	0.67	31.16	15.56	3.00
1500	16.50	20.25	21.20	20.86	1.09	0.66	31.31	15.46	3.08
1600	16.41	20.20	20.99	20.23	1.09	0.65	31.92	15.55	3.10
1700	16.28	20.17	20.95	19.80	1.10	0.65	32.10	15.41	3.09
1800	16.17	20.24	20.88	19.24	1.11	0.63	31.66	15.65	3.06
1900	16.05	20.16	20.89	18.92	1.11	0.63	31.21	15.60	3.12
2000	15.94	20.12	21.08	18.38	1.11	0.63	30.96	15.59	3.09
2100	15.81	20.16	21.11	18.00	1.12	0.62	30.74	15.47	3.11
2200	15.67	20.11	21.35	17.67	1.12	0.61	30.51	15.21	3.12
2300	15.58	20.08	21.35	17.34	1.12	0.61	30.36	15.09	3.12
2400	15.43	19.99	21.44	16.83	1.13	0.60	30.13	15.10	3.11
2500	15.29	20.00	21.51	16.46	1.13	0.59	29.72	15.14	3.17
2600	15.19	19.97	21.95	16.31	1.14	0.58	29.59	15.12	3.10
2700	15.07	19.88	22.24	15.96	1.14	0.58	29.27	14.96	3.14
2800	14.91	19.85	22.50	15.64	1.15	0.57	28.92	15.05	3.18
2900	14.81	19.80	23.13	15.49	1.15	0.57	28.70	14.80	3.14
3000	14.68	19.79	23.63	15.10	1.15	0.56	28.36	14.64	3.09
3100	14.56	19.74	23.94	14.83	1.16	0.56	28.03	14.19	3.17
3200	14.42	19.75	24.24	14.66	1.16	0.55	27.62	14.24	3.16
3300	14.33	19.63	25.00	14.35	1.16	0.55	27.26	14.06	3.20
3400	14.19	19.63	26.13	14.04	1.17	0.54	26.86	13.77	3.26
3500	14.06	19.55	26.17	13.98	1.17	0.54	26.63	13.63	3.25
3600	13.97	19.46	27.57	13.69	1.17	0.53	26.30	13.52	3.27
3700	13.80	19.44	28.32	13.57	1.18	0.52	26.09	13.56	3.30
3800	13.73	19.37	28.74	13.40	1.17	0.52	25.82	13.06	3.30
4000	13.49	19.24	32.78	12.84	1.18	0.52	24.98	12.64	3.17

REV. X1  
ERA-51SM+  
070907  
Page 2 of 11



IF/RF MICROWAVE COMPONENTS • ISO 9001 ISO 14001 AS 9100 CERTIFIED • RoHS compliant

P.O. Box 350166, Brooklyn, New York 11235-0003 (718) 934-4500 Fax (718) 332-4661



The Design Engineers Search Engine finds the model you need, Instantly • For detailed performance specs & shopping online see



# MMIC Amplifier

# ERA-51SM+

## Typical Performance Data

### Definitions:

Input Return Loss = -S11 (dB)

Gain(Power Gain) = S21 (dB)

Reverse Isolation = -S12 (dB)

Output Return Loss = -S22 (dB)

TEST CONDITIONS: Icc = 78mA, Vd = 4.52V @Temperature = +25degC

FREQ	Gain	Isolation	Input Return Loss	Output Return Loss	Stability		IP3 Output	1dB Comp. Output	Noise Figure
					K	Delta			
(MHz)	(dB)	(dB)	(dB)	(dB)	K	Delta	(dBm)	(dBm)	(dB)
50	17.91	20.36	23.54	41.07	1.04	0.75	40.31	19.61	3.14
100	17.86	20.43	23.86	43.21	1.04	0.74	41.21	19.70	3.29
200	17.84	20.51	24.26	36.66	1.05	0.74	44.01	19.61	3.18
300	17.77	20.43	23.55	34.64	1.05	0.74	43.30	19.54	3.25
400	17.74	20.47	23.95	32.47	1.05	0.73	43.40	19.38	3.19
500	17.70	20.56	23.29	30.89	1.05	0.72	40.83	19.31	3.26
600	17.60	20.46	22.60	28.96	1.05	0.72	40.04	19.30	3.26
700	17.53	20.52	22.31	27.81	1.06	0.71	39.11	19.16	3.29
800	17.46	20.50	21.66	26.76	1.06	0.71	38.48	19.03	3.27
900	17.38	20.51	21.35	25.83	1.06	0.70	37.97	18.89	3.21
1000	17.29	20.50	21.21	24.68	1.07	0.70	37.18	18.82	3.20
1100	17.18	20.49	20.70	23.72	1.07	0.69	36.70	18.75	3.19
1200	17.09	20.49	20.51	23.00	1.07	0.68	36.30	18.71	3.24
1300	16.97	20.48	20.56	22.34	1.08	0.67	35.64	18.79	3.25
1400	16.87	20.43	20.44	21.52	1.08	0.67	35.56	18.73	3.13
1500	16.75	20.43	20.06	20.78	1.09	0.66	35.58	18.64	3.20
1600	16.64	20.40	19.95	20.17	1.09	0.66	35.49	18.53	3.24
1700	16.52	20.41	20.02	19.73	1.10	0.65	34.65	18.45	3.19
1800	16.40	20.39	19.91	19.31	1.10	0.64	33.95	18.29	3.19
1900	16.27	20.39	19.99	18.93	1.11	0.63	33.62	18.28	3.25
2000	16.15	20.36	20.18	18.45	1.11	0.63	33.33	18.31	3.24
2100	16.03	20.29	20.20	18.08	1.11	0.62	32.90	18.26	3.22
2200	15.89	20.31	20.56	17.72	1.12	0.61	32.57	18.08	3.28
2300	15.79	20.23	20.58	17.44	1.12	0.61	32.34	17.79	3.24
2400	15.63	20.21	20.60	16.96	1.13	0.60	32.02	17.53	3.26
2500	15.49	20.19	20.71	16.60	1.13	0.59	31.59	17.28	3.32
2600	15.38	20.13	21.13	16.46	1.14	0.59	31.33	17.04	3.30
2700	15.25	20.09	21.32	16.09	1.14	0.58	31.02	16.68	3.26
2800	15.11	20.04	21.62	15.77	1.15	0.58	30.50	16.71	3.35
2900	15.00	20.03	22.30	15.61	1.15	0.57	30.26	16.38	3.29
3000	14.87	19.99	22.77	15.25	1.16	0.56	30.02	16.18	3.24
3100	14.72	19.96	22.87	14.99	1.16	0.56	29.65	15.58	3.32
3200	14.61	19.92	23.36	14.82	1.17	0.55	29.20	15.54	3.31
3300	14.50	19.82	24.22	14.49	1.16	0.55	28.85	15.37	3.37
3400	14.34	19.75	24.64	14.23	1.17	0.54	28.40	15.00	3.39
3500	14.23	19.71	25.24	14.09	1.17	0.54	28.14	14.91	3.43
3600	14.13	19.67	26.33	13.76	1.17	0.53	27.82	14.76	3.43
3700	13.97	19.63	26.92	13.66	1.18	0.53	27.68	14.85	3.47
3800	13.89	19.52	27.76	13.45	1.18	0.53	27.48	14.32	3.44
4000	13.66	19.39	31.22	12.90	1.18	0.52	26.71	13.86	3.33

REV. X1  
ERA-51SM+  
070907  
Page 3 of 11



IF/RF MICROWAVE COMPONENTS • ISO 9001 ISO 14001 AS 9100 CERTIFIED • RoHS compliant

P.O. Box 350166, Brooklyn, New York 11235-0003 (718) 934-4500 Fax (718) 332-4661



The Design Engineers Search Engine finds the model you need, Instantly • For detailed performance specs & shopping online see



# MMIC Amplifier

# ERA-51SM+

## Typical Performance Data

### Definitions:

Input Return Loss = -S11 (dB)

Gain(Power Gain) = S21 (dB)

Reverse Isolation = -S12 (dB)

Output Return Loss = -S22 (dB)

TEST CONDITIONS: Icc = 65mA, Vd = 4.67V @Temperature = -45degC

FREQ	Gain	Isolation	Input Return Loss	Output Return Loss	Stability		IP3 Output	1dB Comp. Output	Noise Figure
					K	Delta			
(MHz)	(dB)	(dB)	(dB)	(dB)	K	Delta	(dBm)	(dBm)	(dB)
50	17.79	20.58	24.58	50.40	1.05	0.72	37.42	18.44	2.65
100	17.74	20.34	25.64	46.27	1.04	0.74	37.63	18.40	2.77
200	17.73	20.31	26.16	39.34	1.04	0.74	39.23	18.47	2.65
300	17.67	20.42	24.62	36.95	1.05	0.73	40.71	18.44	2.67
400	17.63	20.30	25.01	34.19	1.05	0.74	40.72	18.43	2.65
500	17.60	20.38	24.18	31.83	1.05	0.73	41.42	18.38	2.70
600	17.53	20.40	23.35	29.86	1.05	0.72	41.38	18.28	2.69
700	17.46	20.33	22.94	28.62	1.05	0.72	41.42	18.21	2.70
800	17.38	20.40	21.90	27.52	1.06	0.71	41.91	17.98	2.71
900	17.31	20.35	21.73	26.66	1.06	0.71	41.75	17.92	2.64
1000	17.23	20.32	21.48	25.44	1.06	0.71	40.83	17.84	2.64
1100	17.12	20.37	20.99	24.37	1.07	0.69	40.60	17.90	2.62
1200	17.04	20.31	20.60	23.62	1.07	0.69	40.96	17.81	2.65
1300	16.92	20.32	20.41	22.76	1.07	0.68	39.68	17.84	2.66
1400	16.83	20.29	20.14	21.74	1.08	0.68	39.82	17.80	2.53
1500	16.72	20.31	19.82	20.86	1.08	0.67	39.84	17.75	2.61
1600	16.62	20.25	19.66	20.41	1.08	0.67	40.44	17.76	2.65
1700	16.48	20.25	19.60	19.83	1.09	0.66	39.97	17.69	2.61
1800	16.39	20.26	19.30	19.16	1.09	0.65	38.70	17.78	2.59
1900	16.26	20.20	19.40	18.76	1.10	0.65	38.01	17.79	2.65
2000	16.12	20.16	19.46	18.36	1.10	0.64	37.31	17.77	2.63
2100	16.01	20.17	19.48	17.97	1.11	0.63	36.54	17.67	2.62
2200	15.88	20.19	19.66	17.74	1.11	0.62	36.29	17.46	2.61
2300	15.79	20.07	19.89	17.44	1.11	0.62	36.00	17.26	2.63
2400	15.64	20.03	19.89	16.92	1.12	0.61	35.42	17.20	2.64
2500	15.49	20.00	19.86	16.71	1.12	0.61	34.79	17.13	2.69
2600	15.36	20.03	19.93	16.86	1.13	0.59	34.32	17.05	2.64
2700	15.28	19.89	20.30	16.20	1.13	0.60	33.88	16.79	2.63
2800	15.13	19.91	20.39	15.84	1.14	0.59	33.24	16.88	2.70
2900	15.02	19.84	20.81	15.79	1.14	0.59	32.94	16.56	2.65
3000	14.89	19.80	21.41	15.47	1.14	0.58	32.60	16.36	2.63
3100	14.75	19.77	21.45	15.31	1.15	0.57	32.08	15.81	2.67
3200	14.60	19.79	21.40	15.37	1.16	0.56	31.65	15.82	2.67
3300	14.56	19.60	22.41	14.79	1.15	0.57	30.96	15.64	2.75
3400	14.36	19.70	22.22	14.56	1.17	0.55	30.54	15.24	2.76
3500	14.29	19.54	22.98	14.38	1.16	0.55	30.21	15.11	2.76
3600	14.18	19.49	23.66	14.14	1.16	0.55	29.78	14.99	2.77
3700	14.00	19.54	23.37	14.19	1.18	0.54	29.57	15.11	2.83
3800	13.94	19.36	24.55	13.61	1.16	0.54	29.26	14.60	2.79
4000	13.72	19.32	26.26	13.00	1.17	0.53	28.31	14.09	2.68

REV. X1  
ERA-51SM+  
070907  
Page 4 of 11



IF/RF MICROWAVE COMPONENTS • ISO 9001 ISO 14001 AS 9100 CERTIFIED • RoHS compliant

P.O. Box 350166, Brooklyn, New York 11235-0003 (718) 934-4500 Fax (718) 332-4661



The Design Engineers Search Engine finds the model you need, Instantly • For detailed performance specs & shopping online see





# MMIC Amplifier

# ERA-51SM+

## Typical Performance Data

### Definitions:

Input Return Loss = -S11 (dB)

Gain(Power Gain) = S21 (dB)

Reverse Isolation = -S12 (dB)

Output Return Loss = -S22 (dB)

TEST CONDITIONS: Icc = 52mA, Vd = 4.59V @Temperature = -45degC

FREQ	Gain	Isolation	Input Return Loss	Output Return Loss	Stability		IP3 Output	1dB Comp. Output	Noise Figure
					K	Delta			
(MHz)	(dB)	(dB)	(dB)	(dB)	K	Delta	(dBm)	(dBm)	(dB)
50	17.61	20.13	26.45	34.52	1.04	0.75	32.60	16.34	2.59
100	17.59	20.44	28.27	33.82	1.05	0.72	32.37	15.84	2.70
200	17.58	20.09	28.78	34.49	1.04	0.75	33.01	16.01	2.61
300	17.51	20.18	26.70	34.58	1.05	0.74	33.42	16.01	2.61
400	17.48	20.25	27.09	32.66	1.05	0.73	33.26	16.08	2.62
500	17.43	20.24	25.85	30.72	1.05	0.72	33.17	16.08	2.63
600	17.37	20.22	24.82	29.07	1.05	0.72	33.26	15.83	2.65
700	17.30	20.24	24.13	28.24	1.06	0.71	33.70	15.79	2.65
800	17.24	20.23	22.89	27.52	1.06	0.71	33.77	15.37	2.64
900	17.16	20.21	22.70	26.59	1.06	0.71	33.65	15.43	2.58
1000	17.08	20.18	22.41	25.59	1.06	0.70	33.46	15.40	2.59
1100	16.98	20.19	21.83	24.57	1.07	0.70	33.41	15.50	2.56
1200	16.89	20.18	21.37	23.71	1.07	0.69	33.48	15.39	2.58
1300	16.78	20.16	21.06	22.88	1.07	0.68	33.35	15.44	2.61
1400	16.69	20.19	20.74	21.79	1.08	0.68	33.33	15.43	2.47
1500	16.58	20.20	20.48	20.97	1.08	0.67	33.62	15.37	2.55
1600	16.48	20.13	20.24	20.48	1.08	0.67	34.47	15.44	2.59
1700	16.35	20.17	20.23	19.87	1.09	0.65	34.97	15.30	2.54
1800	16.24	20.09	19.85	19.21	1.09	0.65	34.41	15.57	2.53
1900	16.12	20.11	19.85	18.81	1.10	0.64	33.90	15.61	2.61
2000	16.02	20.05	19.97	18.40	1.10	0.64	33.56	15.56	2.56
2100	15.89	20.06	19.98	17.94	1.11	0.63	33.39	15.45	2.57
2200	15.75	20.06	20.14	17.68	1.11	0.62	33.18	15.26	2.55
2300	15.67	19.96	20.34	17.29	1.11	0.62	33.09	15.07	2.58
2400	15.53	19.92	20.41	16.84	1.12	0.61	32.85	15.15	2.58
2500	15.39	19.93	20.29	16.65	1.12	0.60	32.50	15.26	2.65
2600	15.25	19.94	20.29	16.71	1.13	0.59	32.55	15.31	2.59
2700	15.17	19.82	20.73	16.04	1.13	0.60	32.28	15.25	2.57
2800	15.01	19.82	20.88	15.73	1.14	0.59	31.97	15.36	2.65
2900	14.91	19.78	21.29	15.66	1.14	0.58	31.76	15.22	2.57
3000	14.80	19.75	21.81	15.31	1.14	0.57	31.40	15.09	2.57
3100	14.65	19.68	21.89	15.14	1.15	0.57	30.90	14.75	2.60
3200	14.50	19.72	21.79	15.17	1.16	0.56	30.54	14.89	2.63
3300	14.46	19.53	22.91	14.64	1.15	0.57	30.13	14.80	2.67
3400	14.25	19.62	22.87	14.41	1.17	0.55	29.69	14.48	2.70
3500	14.19	19.50	23.53	14.24	1.16	0.55	29.41	14.35	2.70
3600	14.09	19.41	24.24	13.98	1.16	0.55	29.05	14.22	2.70
3700	13.92	19.45	24.06	14.02	1.17	0.54	28.88	14.27	2.76
3800	13.86	19.30	25.28	13.49	1.16	0.54	28.50	13.87	2.70
4000	13.64	19.20	27.46	12.88	1.17	0.53	27.69	13.44	2.62

REV. X1  
ERA-51SM+  
070907  
Page 5 of 11



IF/RF MICROWAVE COMPONENTS • ISO 9001 ISO 14001 AS 9100 CERTIFIED • RoHS compliant

P.O. Box 350166, Brooklyn, New York 11235-0003 (718) 934-4500 Fax (718) 332-4661



The Design Engineers Search Engine finds the model you need, Instantly • For detailed performance specs & shopping online see



# MMIC Amplifier

# ERA-51SM+

## Typical Performance Data

### Definitions:

Input Return Loss = -S11 (dB)

Gain(Power Gain) = S21 (dB)

Reverse Isolation = -S12 (dB)

Output Return Loss = -S22 (dB)

TEST CONDITIONS: Icc = 78mA, Vd = 4.75V @Temperature = -45degC

FREQ	Gain	Isolation	Input Return Loss	Output Return Loss	Stability		IP3 Output	1dB Comp. Output	Noise Figure
					K	Delta			
(MHz)	(dB)	(dB)	(dB)	(dB)	K	Delta	(dBm)	(dBm)	(dB)
50	17.89	20.46	23.06	42.48	1.04	0.74	41.33	19.84	2.71
100	17.88	20.54	24.03	41.69	1.05	0.74	42.18	19.84	2.85
200	17.85	20.37	24.82	37.14	1.04	0.75	44.71	19.81	2.69
300	17.78	20.45	23.48	35.34	1.05	0.74	44.77	19.77	2.75
400	17.73	20.44	23.89	32.75	1.05	0.73	44.24	19.65	2.71
500	17.69	20.42	23.24	31.13	1.05	0.73	43.35	19.59	2.76
600	17.64	20.45	22.50	29.31	1.05	0.73	43.20	19.55	2.74
700	17.56	20.44	22.17	28.32	1.05	0.72	42.01	19.43	2.77
800	17.49	20.43	21.24	26.97	1.06	0.72	41.44	19.30	2.76
900	17.41	20.44	21.07	26.07	1.06	0.71	41.60	19.19	2.70
1000	17.33	20.39	20.90	25.08	1.06	0.71	41.66	19.14	2.70
1100	17.22	20.46	20.42	24.04	1.07	0.69	41.57	19.09	2.68
1200	17.12	20.42	20.17	23.28	1.07	0.69	40.83	19.04	2.70
1300	17.01	20.41	19.97	22.46	1.07	0.68	40.41	19.12	2.73
1400	16.92	20.37	19.70	21.55	1.08	0.68	40.48	19.05	2.61
1500	16.80	20.39	19.38	20.74	1.08	0.67	40.27	19.01	2.67
1600	16.70	20.36	19.28	20.27	1.08	0.67	39.08	18.95	2.72
1700	16.56	20.28	19.24	19.65	1.09	0.66	38.09	18.90	2.66
1800	16.45	20.36	18.96	19.06	1.10	0.65	37.85	18.83	2.66
1900	16.34	20.28	19.04	18.70	1.10	0.65	37.81	18.85	2.69
2000	16.22	20.27	19.12	18.29	1.10	0.64	37.38	18.86	2.68
2100	16.10	20.21	19.10	17.98	1.10	0.64	36.76	18.80	2.66
2200	15.96	20.17	19.36	17.79	1.11	0.63	36.53	18.67	2.67
2300	15.87	20.15	19.58	17.41	1.11	0.62	36.31	18.42	2.70
2400	15.72	20.07	19.63	16.93	1.11	0.62	35.80	18.25	2.70
2500	15.59	20.11	19.58	16.78	1.12	0.61	35.38	18.05	2.75
2600	15.44	20.12	19.57	16.81	1.13	0.59	34.75	17.80	2.71
2700	15.36	19.92	19.95	16.24	1.12	0.60	34.42	17.48	2.70
2800	15.20	19.96	20.09	15.85	1.14	0.59	33.83	17.56	2.78
2900	15.08	19.96	20.41	15.77	1.14	0.58	33.60	17.21	2.70
3000	14.96	19.86	21.02	15.51	1.14	0.58	33.10	17.02	2.70
3100	14.83	19.85	21.12	15.31	1.15	0.57	32.59	16.43	2.76
3200	14.67	19.86	21.06	15.33	1.16	0.56	32.25	16.40	2.76
3300	14.63	19.72	22.05	14.81	1.15	0.57	31.63	16.22	2.83
3400	14.42	19.76	21.79	14.59	1.17	0.55	31.13	15.77	2.82
3500	14.35	19.66	22.50	14.34	1.16	0.55	30.87	15.71	2.85
3600	14.26	19.56	23.08	14.17	1.16	0.55	30.50	15.55	2.84
3700	14.07	19.59	22.87	14.20	1.18	0.54	30.22	15.70	2.91
3800	14.01	19.46	23.89	13.63	1.17	0.54	29.91	15.19	2.85
4000	13.79	19.34	25.29	13.04	1.17	0.54	28.93	14.66	2.77

REV. X1  
ERA-51SM+  
070907  
Page 6 of 11



IF/RF MICROWAVE COMPONENTS • ISO 9001 ISO 14001 AS 9100 CERTIFIED • RoHS compliant

P.O. Box 350166, Brooklyn, New York 11235-0003 (718) 934-4500 Fax (718) 332-4661



The Design Engineers Search Engine finds the model you need, Instantly • For detailed performance specs & shopping online see



# MMIC Amplifier

# ERA-51SM+

## Typical Performance Data

### Definitions:

Input Return Loss = -S11 (dB)

Gain(Power Gain) = S21 (dB)

Reverse Isolation = -S12 (dB)

Output Return Loss = -S22 (dB)

TEST CONDITIONS: Icc = 65mA, Vd = 4.28V @Temperature = +85degC

FREQ	Gain	Isolation	Input Return Loss	Output Return Loss	Stability		IP3 Output	1dB Comp. Output	Noise Figure
					K	Delta			
(MHz)	(dB)	(dB)	(dB)	(dB)	K	Delta	(dBm)	(dBm)	(dB)
50	17.76	20.28	25.72	36.69	1.04	0.75	35.83	18.27	3.41
100	17.73	20.33	25.67	40.95	1.04	0.74	35.81	18.27	3.59
200	17.70	20.53	25.94	41.68	1.05	0.72	36.53	18.25	3.49
300	17.61	20.43	25.32	36.04	1.05	0.72	36.70	18.19	3.57
400	17.55	20.37	26.13	32.69	1.05	0.72	36.23	18.10	3.53
500	17.51	20.37	25.06	30.38	1.05	0.72	35.55	18.05	3.59
600	17.44	20.36	24.32	28.71	1.06	0.72	35.18	17.98	3.59
700	17.36	20.39	23.75	27.69	1.06	0.71	35.12	17.90	3.62
800	17.27	20.43	22.87	26.70	1.06	0.70	34.95	17.70	3.58
900	17.19	20.38	22.77	25.75	1.07	0.70	34.79	17.60	3.55
1000	17.10	20.44	22.42	24.52	1.07	0.69	34.29	17.52	3.54
1100	17.00	20.43	22.05	23.69	1.08	0.68	33.98	17.53	3.52
1200	16.90	20.44	21.73	23.07	1.08	0.67	33.76	17.44	3.59
1300	16.78	20.40	21.83	22.49	1.08	0.67	33.35	17.51	3.59
1400	16.68	20.43	21.60	21.58	1.09	0.66	33.13	17.42	3.47
1500	16.57	20.42	21.34	20.75	1.10	0.65	33.15	17.35	3.54
1600	16.45	20.37	21.06	20.28	1.10	0.64	33.49	17.28	3.58
1700	16.32	20.36	21.09	19.73	1.10	0.64	33.22	17.21	3.55
1800	16.21	20.38	20.90	19.37	1.11	0.63	32.58	17.18	3.50
1900	16.09	20.36	20.93	18.91	1.11	0.62	32.07	17.16	3.60
2000	15.96	20.31	21.16	18.57	1.12	0.61	31.71	17.16	3.56
2100	15.83	20.23	21.43	18.10	1.12	0.61	31.32	17.05	3.56
2200	15.69	20.22	21.63	17.75	1.13	0.60	30.97	16.87	3.57
2300	15.61	20.19	21.61	17.33	1.13	0.60	30.72	16.58	3.58
2400	15.44	20.09	21.86	16.70	1.13	0.59	30.32	16.35	3.59
2500	15.29	20.16	21.78	16.44	1.14	0.58	29.86	16.14	3.66
2600	15.16	20.10	22.09	16.34	1.15	0.57	29.61	15.89	3.60
2700	15.06	20.04	22.96	15.84	1.15	0.57	29.22	15.53	3.59
2800	14.90	20.01	23.16	15.56	1.16	0.56	28.76	15.54	3.67
2900	14.77	20.01	23.90	15.43	1.16	0.55	28.45	15.18	3.61
3000	14.66	19.90	24.80	14.94	1.16	0.55	28.19	14.99	3.57
3100	14.51	19.91	24.93	14.81	1.17	0.54	27.79	14.38	3.65
3200	14.37	19.88	25.07	14.72	1.18	0.53	27.43	14.42	3.66
3300	14.31	19.75	26.94	14.09	1.17	0.54	27.00	14.19	3.69
3400	14.07	19.84	27.32	14.04	1.19	0.52	26.67	13.83	3.74
3500	14.00	19.67	28.92	13.77	1.18	0.52	26.36	13.73	3.77
3600	13.90	19.62	29.98	13.55	1.18	0.52	26.08	13.62	3.76
3700	13.73	19.56	30.56	13.47	1.19	0.51	25.86	13.60	3.80
3800	13.65	19.51	32.17	13.13	1.19	0.51	25.63	13.04	3.84
4000	13.38	19.33	35.77	12.80	1.19	0.50	24.83	12.65	3.66

REV. X1  
ERA-51SM+  
070907  
Page 7 of 11



IF/RF MICROWAVE COMPONENTS • ISO 9001 ISO 14001 AS 9100 CERTIFIED • RoHS compliant

P.O. Box 350166, Brooklyn, New York 11235-0003 (718) 934-4500 Fax (718) 332-4661



The Design Engineers Search Engine finds the model you need, Instantly • For detailed performance specs & shopping online see



# MMIC Amplifier

# ERA-51SM+

## Typical Performance Data

### Definitions:

Input Return Loss = -S11 (dB)

Gain(Power Gain) = S21 (dB)

Reverse Isolation = -S12 (dB)

Output Return Loss = -S22 (dB)

TEST CONDITIONS: Icc = 52mA, Vd = 4.19V @Temperature = +85degC

FREQ	Gain	Isolation	Input Return Loss	Output Return Loss	Stability		IP3 Output	1dB Comp. Output	Noise Figure
					K	Delta			
(MHz)	(dB)	(dB)	(dB)	(dB)	K	Delta	(dBm)	(dBm)	(dB)
50	17.56	20.10	28.84	29.43	1.04	0.74	31.62	16.49	3.35
100	17.52	20.12	29.08	31.27	1.04	0.74	31.46	16.21	3.50
200	17.48	20.39	28.73	33.05	1.05	0.72	31.81	16.39	3.43
300	17.41	20.24	27.43	31.73	1.05	0.72	31.89	16.34	3.49
400	17.37	20.23	28.24	29.72	1.05	0.72	31.52	16.32	3.46
500	17.33	20.25	26.94	28.20	1.06	0.72	31.19	16.31	3.50
600	17.25	20.32	25.93	27.13	1.06	0.70	31.11	16.13	3.53
700	17.18	20.28	25.17	26.47	1.06	0.70	31.18	16.07	3.52
800	17.09	20.26	24.07	25.86	1.07	0.70	31.11	15.68	3.53
900	17.03	20.27	23.87	25.01	1.07	0.69	31.04	15.73	3.49
1000	16.94	20.26	23.25	24.10	1.07	0.69	30.80	15.53	3.49
1100	16.82	20.29	22.78	23.28	1.08	0.68	30.65	15.75	3.45
1200	16.73	20.25	22.38	22.66	1.08	0.67	30.60	15.66	3.51
1300	16.62	20.28	22.49	22.18	1.09	0.66	30.41	15.60	3.51
1400	16.53	20.24	22.12	21.23	1.09	0.66	30.22	15.63	3.39
1500	16.41	20.22	21.85	20.47	1.09	0.65	30.29	15.50	3.46
1600	16.28	20.23	21.54	20.05	1.10	0.64	30.78	15.55	3.48
1700	16.16	20.19	21.51	19.53	1.10	0.64	30.94	15.38	3.48
1800	16.06	20.24	21.39	19.12	1.11	0.63	30.53	15.62	3.42
1900	15.93	20.23	21.34	18.67	1.12	0.62	30.09	15.58	3.54
2000	15.80	20.17	21.52	18.33	1.12	0.61	29.83	15.54	3.47
2100	15.68	20.19	21.77	17.91	1.13	0.60	29.60	15.44	3.49
2200	15.55	20.12	21.88	17.62	1.13	0.60	29.38	15.16	3.47
2300	15.46	20.05	21.99	17.06	1.13	0.60	29.14	15.00	3.49
2400	15.32	19.98	22.17	16.49	1.13	0.59	28.84	14.97	3.50
2500	15.16	19.94	22.03	16.25	1.14	0.58	28.48	14.99	3.58
2600	15.03	20.01	22.33	16.20	1.15	0.57	28.43	14.85	3.52
2700	14.92	19.93	23.24	15.66	1.15	0.57	28.11	14.63	3.53
2800	14.77	19.91	23.34	15.37	1.16	0.56	27.68	14.65	3.57
2900	14.65	19.91	24.21	15.28	1.16	0.55	27.44	14.37	3.56
3000	14.55	19.77	24.98	14.76	1.16	0.55	27.16	14.19	3.48
3100	14.39	19.76	24.90	14.66	1.17	0.54	26.78	13.63	3.57
3200	14.23	19.78	25.07	14.56	1.18	0.53	26.46	13.73	3.58
3300	14.17	19.64	26.82	13.95	1.17	0.53	26.05	13.52	3.61
3400	13.96	19.76	27.47	13.91	1.19	0.51	25.74	13.20	3.67
3500	13.88	19.57	28.62	13.61	1.18	0.52	25.48	13.06	3.65
3600	13.78	19.56	29.27	13.43	1.18	0.51	25.19	12.94	3.66
3700	13.60	19.52	29.32	13.34	1.19	0.50	25.02	12.92	3.71
3800	13.54	19.37	30.02	13.02	1.18	0.51	24.72	12.40	3.74
4000	13.27	19.31	31.54	12.70	1.19	0.49	23.94	12.02	3.58

REV. X1  
ERA-51SM+  
070907  
Page 8 of 11



IF/RF MICROWAVE COMPONENTS • ISO 9001 ISO 14001 AS 9100 CERTIFIED • RoHS compliant  
P.O. Box 350166, Brooklyn, New York 11235-0003 (718) 934-4500 Fax (718) 332-4661



The Design Engineers Search Engine finds the model you need, Instantly • For detailed performance specs & shopping online see



# MMIC Amplifier

# ERA-51SM+

## Typical Performance Data

### Definitions:

Input Return Loss = -S11 (dB)

Gain(Power Gain) = S21 (dB)

Reverse Isolation = -S12 (dB)

Output Return Loss = -S22 (dB)

TEST CONDITIONS: Icc = 78mA, Vd = 4.36V @Temperature = +85degC

FREQ	Gain	Isolation	Input Return Loss	Output Return Loss	Stability		IP3 Output	1dB Comp. Output	Noise Figure
					K	Delta			
(MHz)	(dB)	(dB)	(dB)	(dB)	K	Delta	(dBm)	(dBm)	(dB)
50	17.88	20.43	23.80	52.19	1.04	0.75	39.30	19.46	3.48
100	17.84	20.42	24.28	55.66	1.04	0.74	39.97	19.55	3.68
200	17.82	20.52	24.76	37.79	1.05	0.73	41.33	19.42	3.55
300	17.74	20.49	23.85	35.72	1.05	0.73	40.40	19.32	3.65
400	17.69	20.44	24.62	32.42	1.05	0.73	39.60	19.11	3.60
500	17.63	20.55	23.75	30.66	1.05	0.72	38.28	19.03	3.66
600	17.55	20.48	23.13	28.85	1.06	0.72	37.27	19.05	3.65
700	17.47	20.49	22.92	27.75	1.06	0.71	36.58	18.89	3.67
800	17.38	20.51	22.05	26.62	1.06	0.70	36.12	18.78	3.68
900	17.31	20.55	22.02	25.72	1.07	0.69	35.69	18.62	3.63
1000	17.22	20.51	21.73	24.68	1.07	0.69	34.86	18.53	3.63
1100	17.10	20.51	21.39	23.72	1.08	0.68	34.45	18.42	3.61
1200	17.01	20.51	21.18	23.11	1.08	0.67	34.09	18.39	3.66
1300	16.89	20.52	21.31	22.52	1.09	0.66	33.54	18.49	3.65
1400	16.78	20.48	21.11	21.65	1.09	0.66	33.45	18.40	3.55
1500	16.67	20.52	20.89	20.84	1.09	0.65	33.42	18.28	3.59
1600	16.56	20.45	20.63	20.35	1.10	0.65	33.35	18.12	3.67
1700	16.43	20.42	20.74	19.85	1.10	0.64	32.56	17.99	3.62
1800	16.30	20.40	20.59	19.45	1.11	0.63	32.06	17.78	3.61
1900	16.17	20.38	20.63	19.05	1.11	0.62	31.72	17.75	3.67
2000	16.04	20.40	20.82	18.70	1.12	0.61	31.35	17.78	3.64
2100	15.93	20.41	21.08	18.24	1.13	0.61	31.05	17.72	3.63
2200	15.79	20.29	21.37	17.85	1.13	0.60	30.73	17.50	3.68
2300	15.69	20.25	21.45	17.37	1.13	0.60	30.53	17.18	3.67
2400	15.53	20.19	21.57	16.81	1.13	0.59	30.26	16.93	3.69
2500	15.38	20.24	21.49	16.55	1.14	0.58	29.89	16.65	3.75
2600	15.23	20.25	21.86	16.51	1.15	0.57	29.74	16.38	3.69
2700	15.14	20.08	22.59	15.95	1.15	0.57	29.44	16.03	3.69
2800	14.96	20.13	22.80	15.66	1.16	0.56	28.98	16.02	3.74
2900	14.85	20.06	23.58	15.57	1.16	0.56	28.79	15.70	3.70
3000	14.74	19.96	24.50	15.10	1.16	0.55	28.59	15.50	3.64
3100	14.58	19.93	24.63	14.91	1.17	0.55	28.15	14.90	3.74
3200	14.44	19.93	24.86	14.85	1.18	0.54	27.91	14.90	3.75
3300	14.38	19.82	26.72	14.18	1.17	0.54	27.47	14.70	3.77
3400	14.14	19.87	26.65	14.15	1.19	0.52	27.14	14.34	3.83
3500	14.07	19.74	28.50	13.86	1.18	0.52	26.88	14.21	3.86
3600	13.96	19.70	29.95	13.65	1.19	0.52	26.59	14.08	3.86
3700	13.80	19.68	30.60	13.57	1.20	0.51	26.50	14.08	3.90
3800	13.73	19.52	32.86	13.25	1.18	0.51	26.34	13.59	3.90
4000	13.44	19.46	38.44	12.89	1.20	0.50	25.74	13.18	3.76

REV. X1  
ERA-51SM+  
070907  
Page 9 of 11



IF/RF MICROWAVE COMPONENTS • ISO 9001 ISO 14001 AS 9100 CERTIFIED • RoHS compliant

P.O. Box 350166, Brooklyn, New York 11235-0003 (718) 934-4500 Fax (718) 332-4661



The Design Engineers Search Engine finds the model you need, Instantly • For detailed performance specs & shopping online see



## Typical Performance Curves

**GAIN vs. TEMPERATURE**

INPUT POWER = -20dBm, CURRENT = 65mA

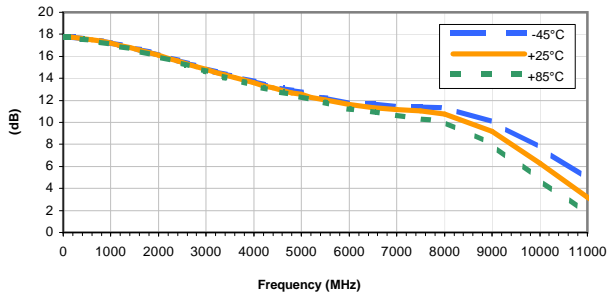

**GAIN vs. CURRENT**

INPUT POWER = -20dBm, Temperature = +25°C

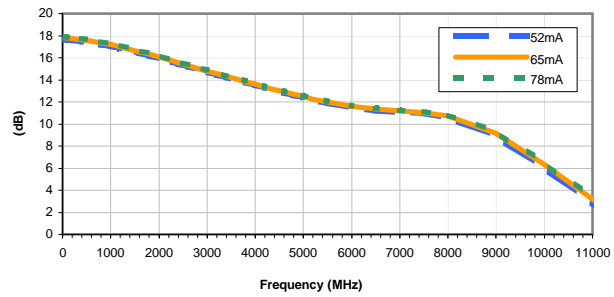

**ISOLATION vs. TEMPERATURE**

INPUT POWER = -20dBm, CURRENT = 65mA

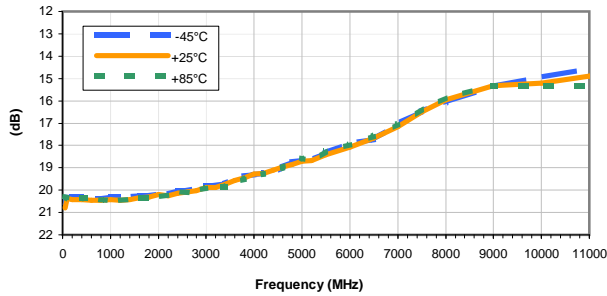

**ISOLATION vs. CURRENT**

INPUT POWER = -20dBm, Temperature = +25°C

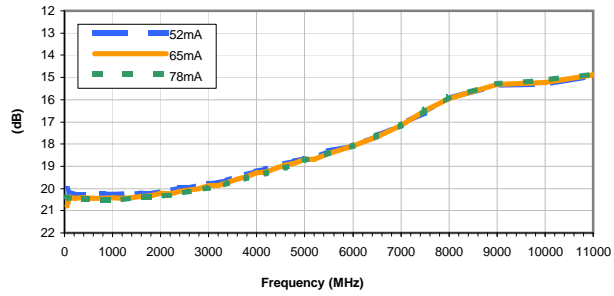

**INPUT RETURN LOSS vs. TEMPERATURE**

INPUT POWER = -20dBm, CURRENT = 65mA

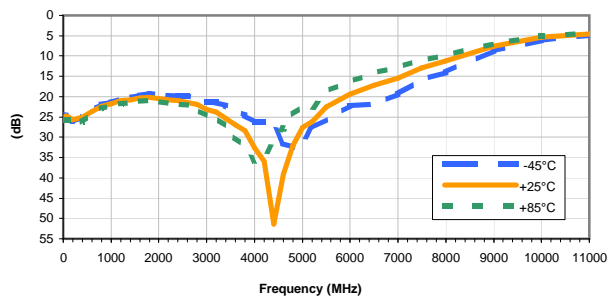

**INPUT RETURN LOSS vs. CURRENT**

INPUT POWER = -20dBm, Temperature = +25°C

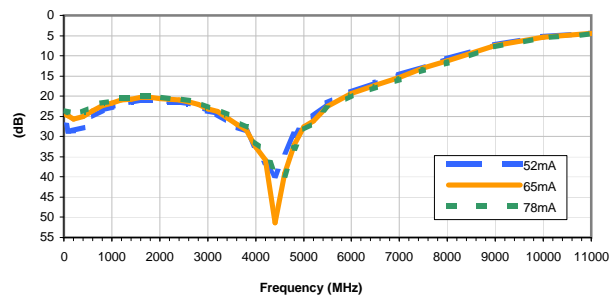

**OUTPUT RETURN LOSS vs. TEMPERATURE**

INPUT POWER = -20dBm, CURRENT = 65mA

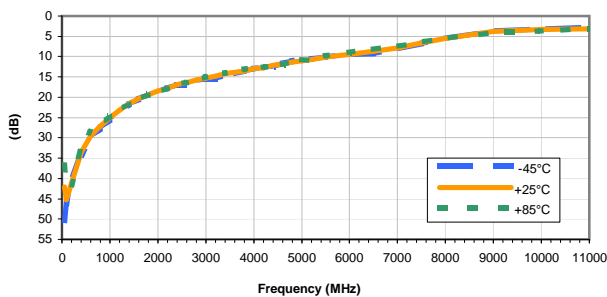

**OUTPUT RETURN LOSS vs. CURRENT**

INPUT POWER = -20dBm, Temperature = +25°C

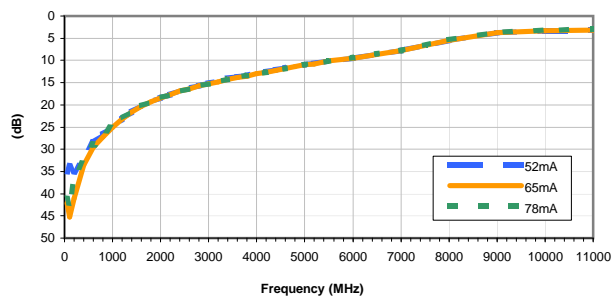

REV. X1

ERA-51SM+

070907

Page 10 of 11



IF/RF MICROWAVE COMPONENTS • ISO 9001 ISO 14001 AS 9100 CERTIFIED • RoHS compliant

P.O. Box 350166, Brooklyn, New York 11235-0003 (718) 934-4500 Fax (718) 332-4661



The Design Engineers Search Engine finds the model you need, Instantly • For detailed performance specs & shopping online see



## Typical Performance Curves

OUTPUT IP3 vs. TEMPERATURE

INPUT POWER = -20dBm, CURRENT = 65mA

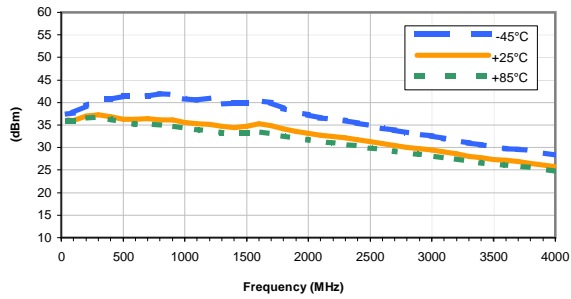

OUTPUT IP3 vs. CURRENT

INPUT POWER = -20dBm, Temperature = +25°C

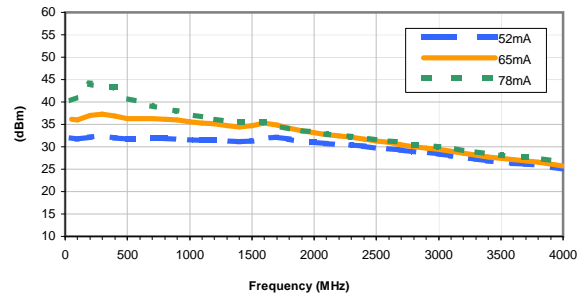

OUTPUT POWER at 1dB Compression vs. TEMPERATURE

CURRENT = 65mA

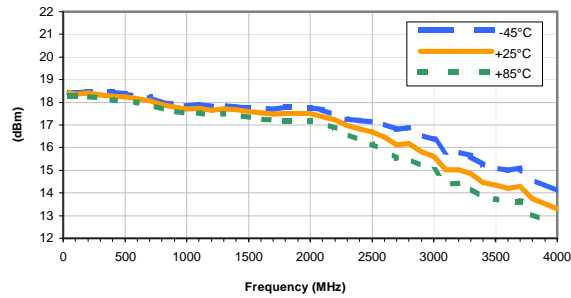

OUTPUT POWER at 1dB Compression vs. CURRENT

Temperature = +25°C

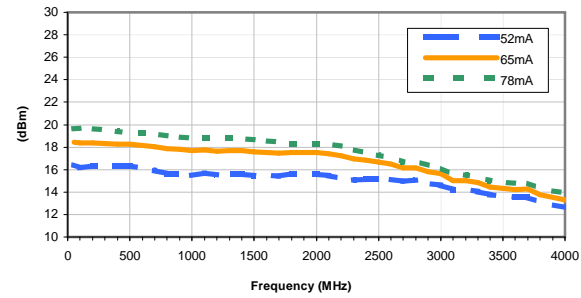

Noise Figure vs. TEMPERATURE

CURRENT = 65mA

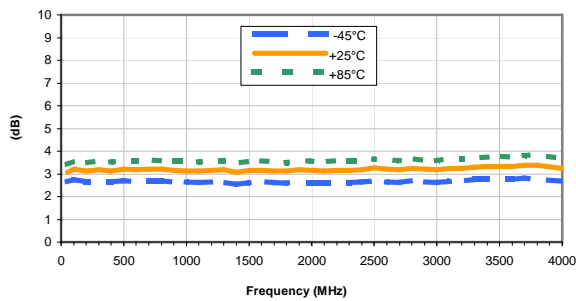

Noise Figure vs. CURRENT

Temperature = +25°C

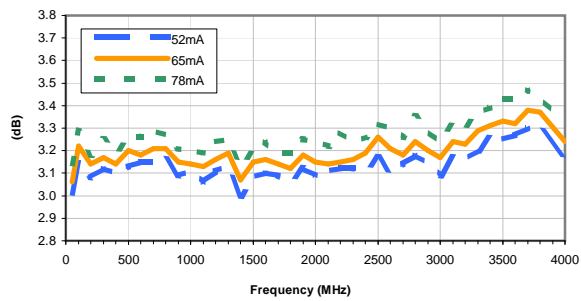

IF/RF MICROWAVE COMPONENTS • ISO 9001 ISO 14001 AS 9100 CERTIFIED RoHS compliant  
 P.O. Box 350166, Brooklyn, New York 11235-0003 (718) 934-4500 Fax (718) 332-4661



The Design Engineers Search Engine finds the model you need, Instantly • For detailed performance specs & shopping online see



## Typical Performance Curves

**GAIN vs. TEMPERATURE**

INPUT POWER = -20dBm, CURRENT = 65mA

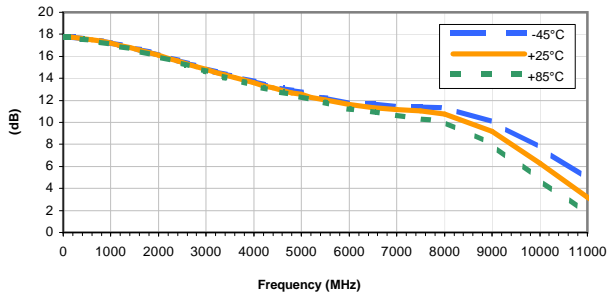

**GAIN vs. CURRENT**

INPUT POWER = -20dBm, Temperature = +25°C

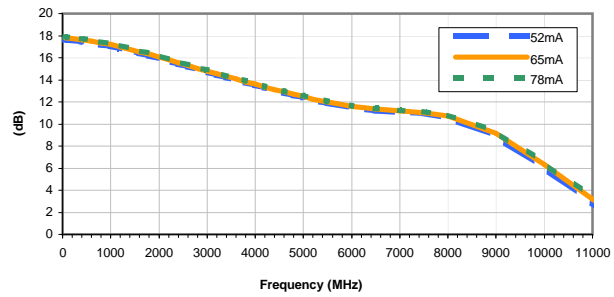

**ISOLATION vs. TEMPERATURE**

INPUT POWER = -20dBm, CURRENT = 65mA

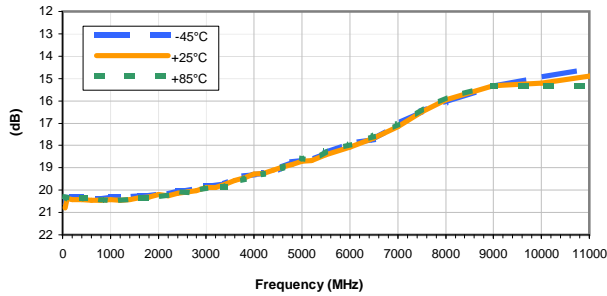

**ISOLATION vs. CURRENT**

INPUT POWER = -20dBm, Temperature = +25°C

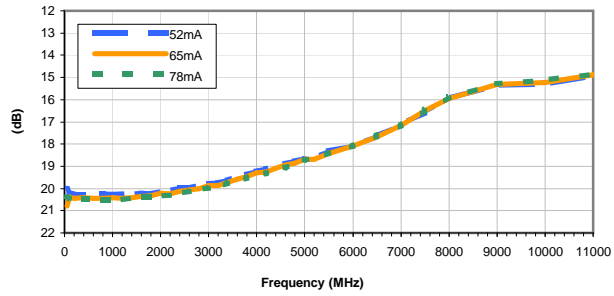

**INPUT RETURN LOSS vs. TEMPERATURE**

INPUT POWER = -20dBm, CURRENT = 65mA

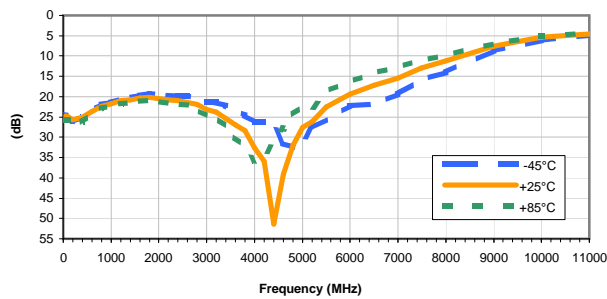

**INPUT RETURN LOSS vs. CURRENT**

INPUT POWER = -20dBm, Temperature = +25°C

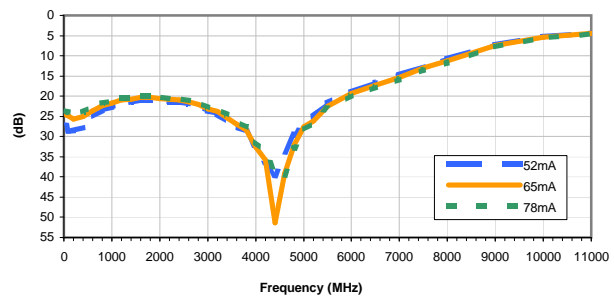

**OUTPUT RETURN LOSS vs. TEMPERATURE**

INPUT POWER = -20dBm, CURRENT = 65mA

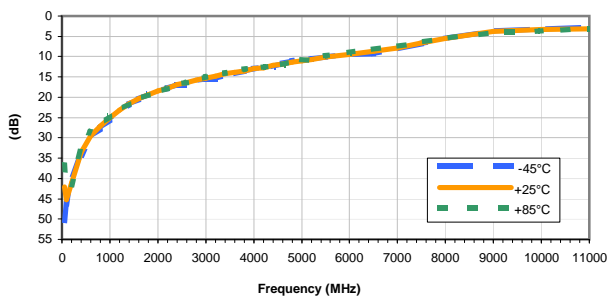

**OUTPUT RETURN LOSS vs. CURRENT**

INPUT POWER = -20dBm, Temperature = +25°C

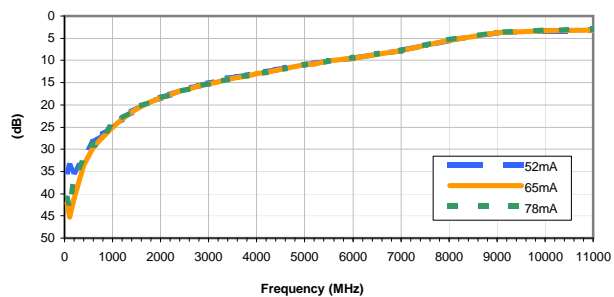



## Typical Performance Curves

**OUTPUT IP3 vs. TEMPERATURE**

INPUT POWER = -20dBm, CURRENT = 65mA

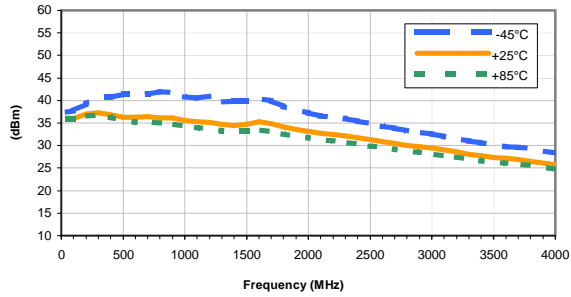

**OUTPUT IP3 vs. CURRENT**

INPUT POWER = -20dBm, Temperature = +25°C

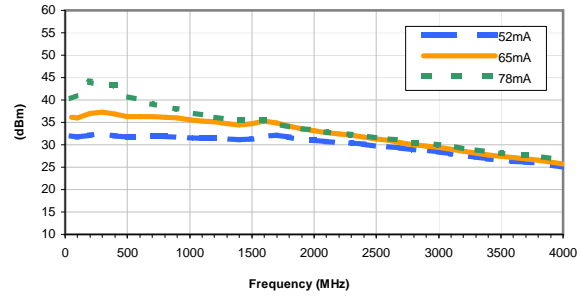

**OUTPUT POWER at 1dB Compression vs. TEMPERATURE**

CURRENT = 65mA

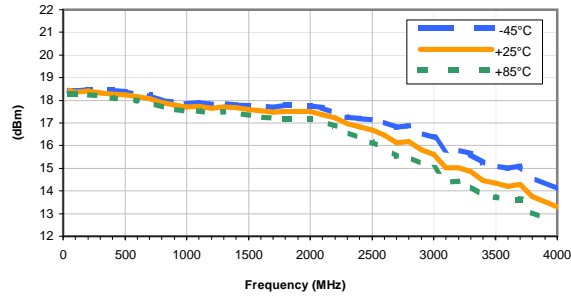

**OUTPUT POWER at 1dB Compression vs. CURRENT**

Temperature = +25°C

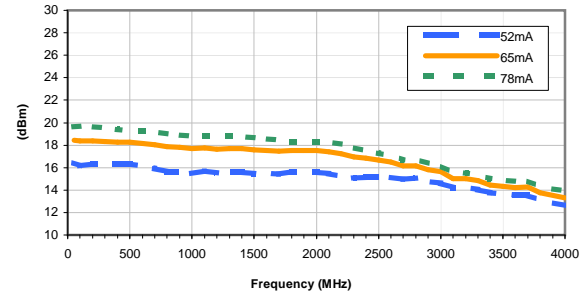

**Noise Figure vs. TEMPERATURE**

CURRENT = 65mA

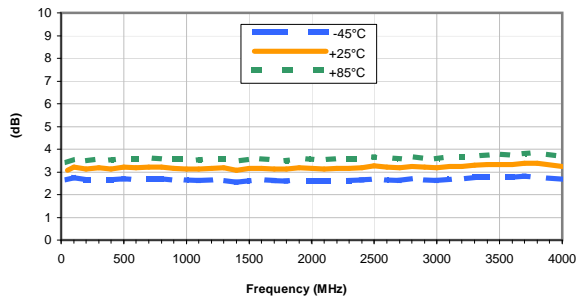

**Noise Figure vs. CURRENT**

Temperature = +25°C

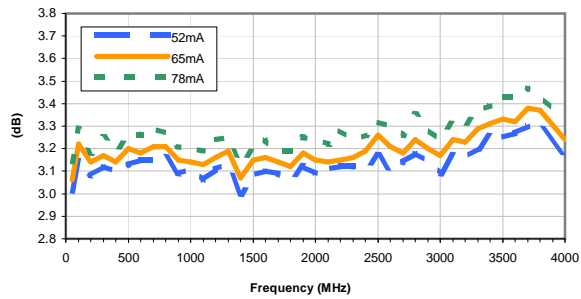

### Outline Dimensions

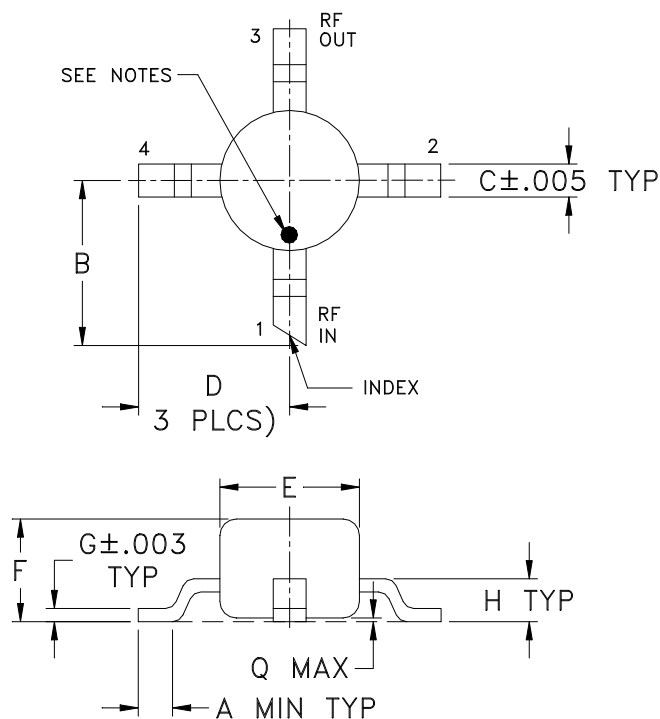

### PCB Land Pattern

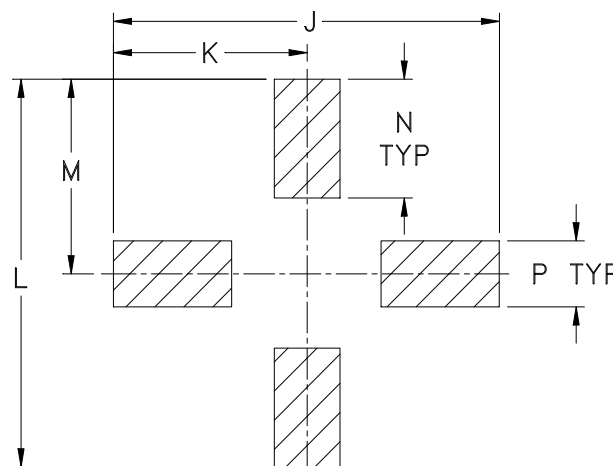

Suggested Layout,  
Tolerance to be within  $\pm .002$

CASE#	A	B	C	D	E	F	G	H	J	K	L	M	N	P	Q	WT. GRAMS
WW107	.012 (0.30)	.10 (2.54)	.020 (0.51)	.092 (2.34)	.085 (2.16)	.060 (1.52)	.007 (0.18)	.026 (0.66)	.235 (5.97)	.118 (3.00)	.235 (5.97)	.118 (3.00)	.072 (1.83)	.040 (1.02)	.020 (0.51)	.015

Dimensions are in inches (mm). Tolerances: 2 Pl.  $\pm .03$ ; 3 Pl.  $\pm .015$

#### Notes:

- Case material: Plastic.
- Termination finish:  
For RoHS Case Styles: Matte tin Plate.  
For RoHS-5 Case Styles: Tin-Lead plate.
- RF input termination (1) identified by one or both of the following at factory option:
  - diagonally cut termination, which may be  $45^\circ$  (ref) in either direction;
  - orientation mark on the case. Model dash number is identified by color dot or alphanumeric code on case. See specification data sheet.



INTERNET <http://www.minicircuits.com>

P.O. Box 350166, Brooklyn, New York 11235-0003 (718) 934-4500

Distribution Centers NORTH AMERICA 800-654-7949 • 417-335-5935 • Fax 417-335-5945 • EUROPE 44-1252-1

Mini-Circuits ISO 9001 & ISO 14001 Certified

# Tape & Reel Packaging TR-F4

## DEVICE ORIENTATION IN T&R

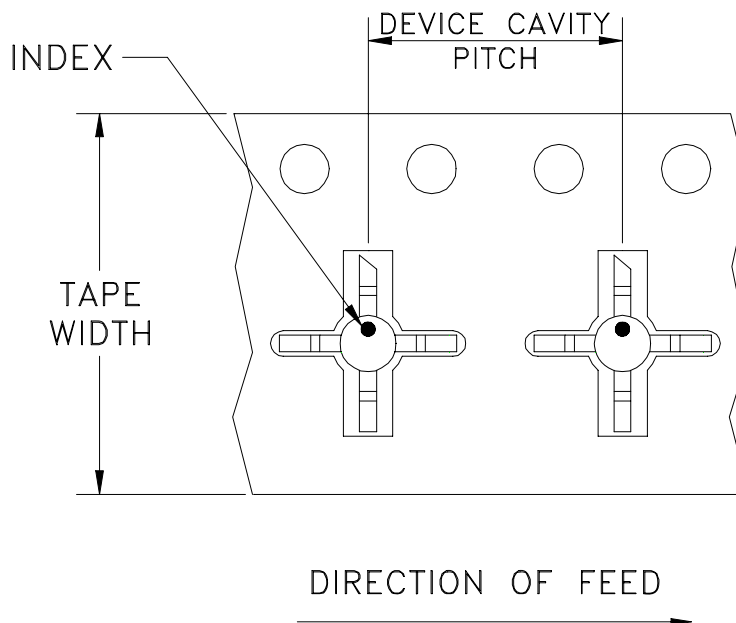

Tape Width, mm	Device Cavity Pitch, mm	Reel Size, inches	Devices per Reel	
12	8	7	Small quantity standards (see note)	20
				50
				100
				200
				500
		7	Standard	1000

Note: Please Consult individual model data sheet to determine device per reel availability.

Mini-Circuits carrier tape materials provide protection from ESD (Electro-Static Discharge) during handling and transportation. Tapes are static dissipative and comply with industry standards EIA-481/EIA-541.

Go to: [www.minicircuits.com/pages/pdfs/tape.pdf](http://www.minicircuits.com/pages/pdfs/tape.pdf)



INTERNET <http://www.minicircuits.com>

P.O. Box 350166, Brooklyn, New York 11235-0003 (718) 934-4500 Fax (718) 332-4661

Distribution Centers NORTH AMERICA 800-654-7949 • 417-335-5935 • Fax 417-335-5945 • EUROPE 44-1252-832600 • Fax 44-1252-837010

Mini-Circuits ISO 9001 & ISO 14001 Certified

THIRD ANGLE PROJECTION

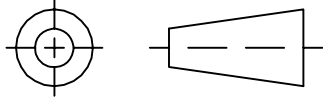

REVISIONS

REV	ECN No.	DESCRIPTION	DATE	DR	AUTH
A	M100215	ADDED "PACKAGE OUTLINE" & UPDATED NOTES	08/12/05	MMG	MM
B	M100944	REMOVED AF190 & UPDATED NOTES	09/23/05	GT	MM
C	M102713	ADDED "...WITH SMOBC"	01/14/06	GF	IL
D	M108434	UPDATED DRAWING PER TB-408+	11/14/06	PW	IG

SUGGESTED MOUNTING CONFIGURATION FOR  
WW107 CASE STYLE, "cb" PIN CONNECTION

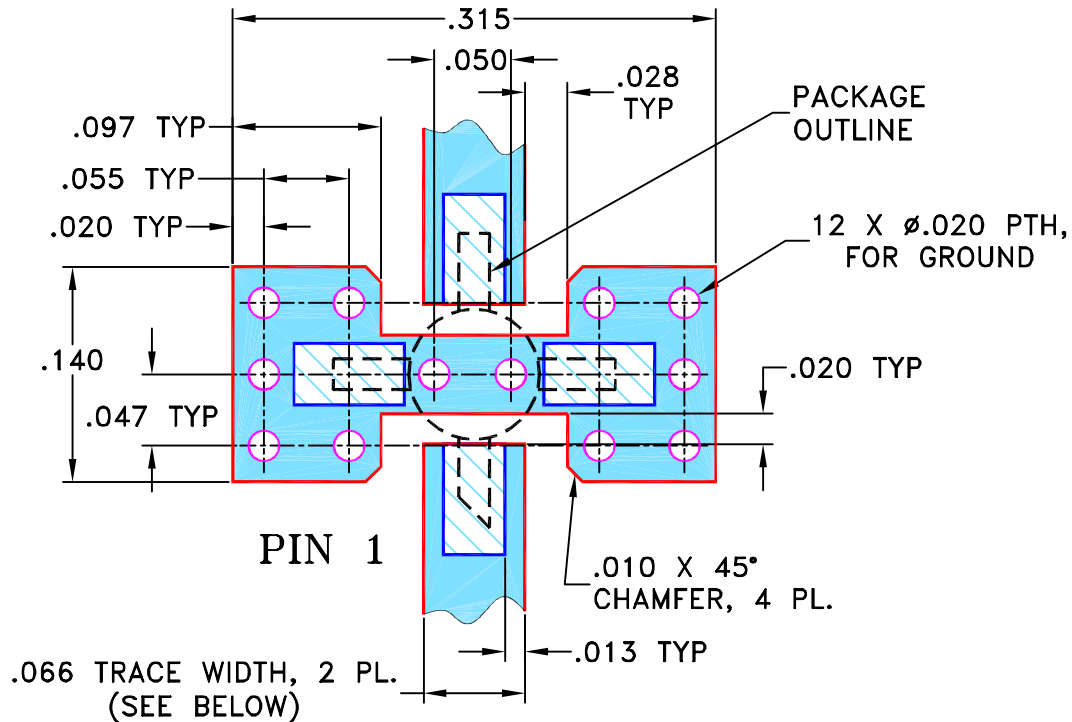

NOTES:

1. TRACE WIDTH IS SHOWN FOR ROGERS R04350B WITH DIELECTRIC THICKNESS .030" ± .002"; COPPER: 1/2 OZ. EACH SIDE. FOR OTHER MATERIALS TRACE WIDTH MAY NEED TO BE MODIFIED.
2. BOTTOM SIDE OF THE PCB IS CONTINUOUS GROUND PLANE.
3. IF PCB DESIGN RULES ALLOW, PLACE GROUND VIAS UNDER THE LAND PATTERN FOR BETTER RF PERFORMANCE. OTHERWISE PLACE GROUND VIAS AS CLOSE TO LAND PATTERN AS POSSIBLE.

- DENOTES PCB COPPER LAYOUT WITH SMOBC (SOLDER MASK OVER BARE COPPER)
- DENOTES COPPER LAND PATTERN FREE OF SOLDER MASK

UNLESS OTHERWISE SPECIFIED	INITIALS	DATE
DIMENSIONS ARE IN INCHES	DRAWN GF	07/18/02
TOLERANCES ON:	CHECKED LC	08/01/02
2 PL DECIMALS ±	APPROVED DJ	08/05/02
3 PL DECIMALS ± .005		
ANGLES ±		
FRACTIONS ±		



**Mini-Circuits®**

13 Neptune Avenue  
Brooklyn NY 11235

PL, cb, WW107, ERA, TB-408-XX+

Mini-Circuits®  
THIS DOCUMENT AND ITS CONTENTS ARE THE PROPERTY OF MINI-CIRCUITS. EXCEPT FOR USE EXPRESSLY GRANTED, IN WRITING, TO ITS VENDORS, VENDEE AND THE UNITED STATES GOVERNMENT, MINI-CIRCUITS RESERVES ALL PROPRIETARY DESIGN, USE, MANUFACTURING AND REPRODUCTION RIGHTS THERETO. THESE CONTENTS SHALL NOT BE USED, DUPLICATED OR DISCLOSED TO ANY OUTSIDE PARTY, IN WHOLE OR IN PART, WITHOUT WRITTEN PERMISSION OF MINI-CIRCUITS.

SIZE	CODE IDENT	DRAWING NO:	REV:
A	15542	98-PL-075	D
FILE:	98PL075	SCALE: 8:1	SHEET: 1 OF 1

# Evaluation Board and Circuit

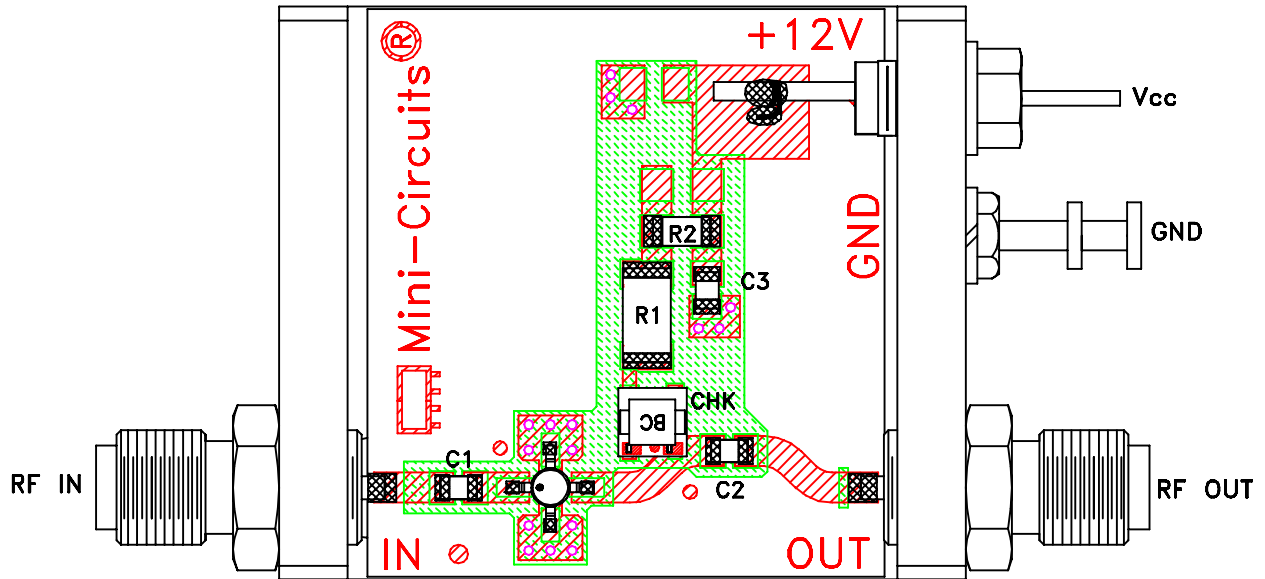

TB-408-51+

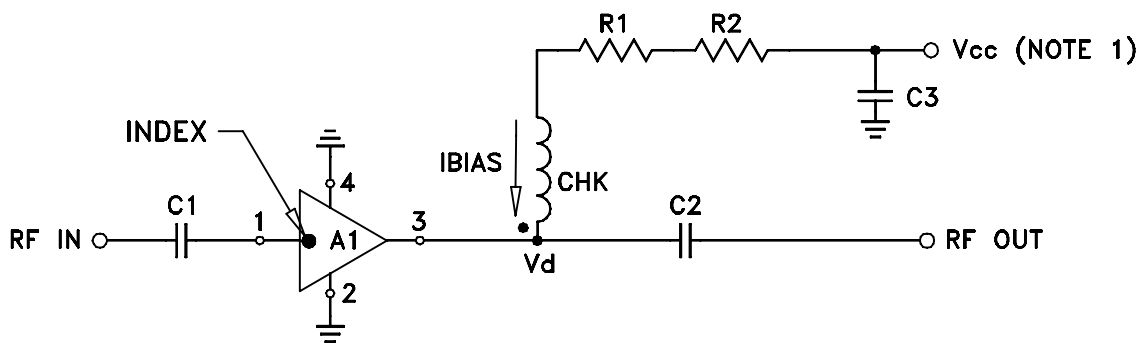

COMPONENT	VALUE
A1	ERA-51SM(+)
C1 (NOTE 4)	2400 pF
C2 (NOTE 4)	2400 pF
C3 (bypass)	0.1 uF
R1	115 Ohms, 0.75W
R2	0 Ohm, 0.25W
CHK	Mini-Circuits TCCH-80+

Schematic Diagram

**NOTE:**

1. Vcc voltage:  $+12 \pm 0.2V$ .
2. SMA Female connectors.
3. PCB material: Rogers R04350 or equivalent, dielectric constant=3.5, dielectric thickness=.030 inch.
4. Capacitors, C1 & C2 should be free of resonance up to the highest frequency specified.

Mini-Circuits®