



CP Plastik Serisi Ø 22 mm Adaptörlü Kumanda Butonları (IP65)

- İşlevsel özellikleri artırılmış ve basma düğmesinden kolaylıkla sökülebilen adaptör.
- Lego mantığı ile ardarda eklenebilen ve montaj mesafesini azaltan küçük tasarımlı kontak bloklar.
- İnsan hayatına değer veren (V0) PA6 gövde ile kontak blokların güvenilirliği.
- Işıklı blok eklenerek durum takip kolaylığı.
- Silikon conta kullanılmış IP65 koruma sınıfı ve parmak ergonomisine daha uygun; estetik basma düğmesi.
- Can güvenliği açısından korumalı kablo giriş uçları.
- Korumalı LED'ler ile minimum ısınma, maksimum ömür.
- Rozet ve etiket çeşitleri ile konumlandırma imkanı.
- Tüm uygulamalara cevap verecek ürün çeşitliliği.

Teknik Bilgiler

Mekanik Ömür	: 500.000 açma-kapama min.
Elektriksel Ömür	: 100.000 açma-kapama min.
Çalışma Sıcaklığı	: min./maks. °C -5/+40
Koruma Sınıfı	: IP65
Çalışma Sıklığı	: Yüksüz 3000 açma-kapama/saat Yükte 1200 açma-kapama/saat
Anma İşletme Gerilimi Ue	: 230 V AC
Anma İşletme Akımı Ie	: 4 A
Yalıtım Gerilimi Ui	: 300 V
Darbe Dayanım Gerilimi Uimp	: 2.5 kV
Standart Kontak Malzemesi	: AgNi
İzolasyon Direnci	: 10 MΩ min. (500 V DC)
Dielektrik Mukavemeti	: Gövde-Kontak arası 2000 V AC Açık Kontak 1500 V AC
Bağlantı Kablo Kesiti	: 1.5-2.5 mm ²
Standart	: TS EN 60947-5-1 VDE0660



CP Plastic Series Ø 22 mm Push Buttons With Adapter (IP65)

- Functional specifications are maximized and adapter, which is facilitated to take apart easily.
- Sequential connectable body and contact blocks after lego logic.
- Contact blocks reliability with incombustible V0 PA6 body.
- Status follow up possibility by adding illumination unit.
- IP65 Protection degree with silicon band, finger ergonomic and aesthetic button.
- Protective cable inlet tips enabling maximum safety
- Minimum warm up, maximum life with protected LED's.
- Position facility with badge and label kinds.
- Product variety fulfilling of all applications.

Technical Information





















Mechanical Life	: 500.000 operations min.
Electrical Life	: 100.000 operations min.
Operating Temperature	: min./max. °C -5/+40
Protection Degree	: IP65
Operating Frequency	: Without load 3000 operations/hour At full load 1200 operations/hour
Rated Operating Voltage Ue	: 230 V AC
Rated Operating Current Ie	: 4 A
Insulation Voltage Ui	: 300 V
Stroke Resistance Voltage Uimp	: 2.5 kV
Standard Contact Material	: AgNi
Insulation Resistance	: 10 MΩ min. (500 V DC)
Dielectrical Strength	: Between body-contact 2000 V AC Open contact 1500 V AC
Connection Cable Cross-Section	: 1.5-2.5 mm ²
Standard	: TS EN 60947-5-1 VDE0660



Kumanda Butonları ve Sinyal Lambaları

Push Buttons and Signal Lamps

Genel Şema / General Scheme

1		1) Düz Kafalı Yaylı Buton	1) Flush, Spring Return	15	
2		2) Çiftli Düz Kafalı Yaylı Buton	2) Double, Spring Return	16	
3		3) Seçici Buton	3) Selector Switch	17	
4		4) Ø 30 mm Acil Stop Butonu Çekmeli veya Çevirmeli	4) Emergency Stop Button Ø 30 mm Release on / Twist On	18	
5		5) Pencere Acil Stop Butonu	5) With Window Emergency Stop Button	19	
6		6) 40 mm Acil Stop Butonu	6) 40 mm Emergency Stop Button	20	
7		7) Anahtarlı Emniyet Butonu	7) Key Operated	21	
8		8) Işıklı 30 mm Acil Stop Butonu	9) With Signal Emergency Stop Button 30 mm	22	
9		9) Anahtarlı Buton	8) Key Operated Button	23	
10		10) Joyistik Buton	10) Joystick Button	24	
11		11) Sinyal Lambası	11) Signal Lamps		

25



12



26



13



14



8) Anahtarlı Buton

9) With Signal Emergency Stop Button 30 mm

10) Joyistik Buton

11) Sinyal Lambası

12) Rozet 8 mm-18 mm

13) C Adaptör

14) CEK Adaptör

15) Start Kontak Blok - 100

16) Stop Kontak Blok - 200

17) Çift Start - 101

18) Çift Stop - 202

19) Start Stop - 102

20) C12 Joystick kontak blok monoblok 1NA 1NK

21) Start Işık Bloklü

22) Stop Işık Bloklü

23) Start Işık Blok Stop

24) Ledli Işık Bloğu

25) Emniyet Basma Düğmesi Darbe Muhafazası

26) Acil Stop Etiket (Plastik/Alüminyum) Ø 60 mm - Ø 90 mm

* Etiket Çeşitleri / Selection of Button Plates:

START

STOP

O I

O I

II O I

II O I

II O I

CM Metal Serisi Ø 22 mm Adaptörlü Kumanda Butonları (IP65)

- İşlevsel özellikleri arttırılmış ve basma düğmesinden kolaylıkla sökülebilen adaptör.
- Lego mantığı ile ardarda eklenebilen ve montaj mesafesini azaltan küçük tasarımlı kontak bloklar.
- İnsan hayatına değer veren (V0) PA6 gövde ile kontak blokların güvenilirliği.
- Işıklı blok eklenerek durum takip kolaylığı.
- Silikon conta kullanılmış IP65 koruma sınıfı ve parmak ergonomisine daha uygun estetik basma düğmesi.
- Ağır koşullara dayanıklı metal gövdeli basma düğmeleri.
- Pano montajını daha sağlam yapan metal montaj bileziği.
- Can güvenliği açısından korumalı kablo giriş uçları.
- Korumalı LED'ler ile minimum ısınma, maksimum ömür.
- Rozet ve etiket çeşitleri ile konumlandırma imkanı.
- Tüm uygulamalara cevap verecek ürün çeşitliliği.

Teknik Bilgiler

Mekanik Ömür	: 500.000 açma-kapama min.
Elektriksel Ömür	: 100.000 açma-kapama min.
Çalışma Sıcaklığı	: min./maks. °C -5/+40
Koruma Sınıfı	: IP65
Çalışma Sıklığı	: Yüksüz 3000 açma-kapama/saat Yükte 1200 açma-kapama/saat

Anma İşletme Gerilimi Ue	: 230 V AC
Anma İşletme Akımı Ie	: 4 A
Yalıtım Gerilimi Ui	: 300 V
Darbe Dayanım Gerilimi Uimp	: 2.5 kV
Standart Kontak Malzemesi	: AgNi
Izolasyon Direnci	: 10 MΩ min. (500 V DC)
Dielektrik Mukavemeti	: Gövde-Kontak arası 2000 V AC Açık Kontak 1500 V AC

Bağlantı Kablo Kesiti	: 1.5-2.5 mm ²
Standart	: TS EN 60947-5-1 VDE0660



CM Metal Series Ø 22 mm Push Buttons With Adapter (IP65)

- Functional specifications are maximized and adapter, which is facilitated to take apart easily.
- Sequential connectable body and contact blocks after lego logic.
- Contact blocks reliability with incombustible V0 PA6 body.
- Status follow up possibility by adding illumination unit.
- In heavy conditions enduring metal construction push buttons.
- Metal mounting bracelet strengthening panel mounting
- Protective cable inlet tips enabling maximum safety
- Minimum warm up, maximum life with protected LED's.
- Position facility with badge and label kinds.
- Product variety fulfilling of all applications.
- IP65 Protection degree with silicon band, finger ergonomic and aesthetic button.

Technical Information

Mechanical Life	: 500.000 operations min.
Electrical Life	: 100.000 operations min.
Operating Temperature	: min./max. °C -5/+40
Protection Degree	: IP65
Operating Frequency	: Without load 3000 operations/hour At full load 1200 operations/hour

Rated Operating Voltage Ue	: 230 V AC
Rated Operating Current Ie	: 4 A
Insulation Voltage Ui	: 300 V
Stroke Resistance Voltage Uimp	: 2.5 kV
Standard Contact Material	: AgNi
Insulation Resistance	: 10 MΩ min. (500 V DC)
Dielectrical Strength	: Between body-contact 2000 V AC Open contact 1500 V AC

Connection Cable Cross-Section	: 1.5-2.5 mm ²
Standard	: TS EN 60947-5-1 VDE0660





Kumanda Butonları ve Sinyal Lambaları

Push Buttons and Signal Lamps

Genel Şema / General Scheme

1 

2 

3 

4 

5 

6 

7 

8 

21 

9 

11 

10 

22 

12 

13 

14 

15 

16 

17 

18 

19 

20 

1) Düz Kafalı Yaylı Buton
2) Çiftli Düz Kafalı Yaylı Buton
3) Seçici Buton
4) Anahtarlı Metal Buton
5) Acil Stop Butonu
6) Mantar Kafalı Yaylı Buton

7) Joyistik Buton
8) Sinyal Lambası
9) Rozet 8 mm-18 mm
10) C Adaptör
11) CM Montaj Bileziği (Metal)
12) Start Kontak Blok - 100
13) Stop Kontak Blok - 200
14) Çift Start - 101
15) Çift Stop - 202
16) Start Stop - 102
17) Start Işık Bloklu
18) Stop Işık Bloklu
19) Start Işık Blok Stop
20) Ledli Işık Bloğu
21) Emniyet Basma Düğmesi
Darbe Muhafazası
22) Acil Stop Etiketleri (Plastik/Alüminyum)
Ø 60 mm - Ø 90 mm

1) Flush, Spring Return
2) Double, Spring Return
3) Selector Switch
4) With key Metal Button
5) Emergency Stop Button
6) Mushroom Head, Spring Return

7) Joystick Button
8) Signal Lamps
9) Badge 8 mm-18 mm
10) C Adapter
11) CM Mounting bracelet (Metal)
12) Start Contact Block - 100
13) Stop Contact Block - 200
14) Double Start - 101
15) Double Stop - 202
16) Start Stop - 102
17) Start Illumination Block
18) Stop Illumination Block
19) Start Illumination Block Stop
20) Led Illumination Block
21) Emergency Push Button
Plate Protection
22) Plate Ø 60 mm - Ø 90 mm
Emergency Stop (Plastic/Aluminium)

* Etiket Çeşitleri / Selection of Button Plates:

START STOP O I O I II O I II O I II O I

C Serisi Kumanda Butonları Seçim Tablosu

Series Push Buttons Selection Table

Seri	Kontakt Blok Kombinasyonu	Buton Tipi	Renk
CM	1 K 2	D	K
Series	Contact Block Combination	Button Type	Colour

CP CP Plastik Serisi Ø 22 mm Kumanda Butonu
CP Series Ø 22 mm Push Buttons

CM CM Metal Serisi Ø 22 mm Kumanda Butonu
CM Series Ø 22 mm Push Buttons

Yaylı Tip Butonlar / Stringed Type Buttons

D	Düz, Yuvarlak Flush
M	Mantar Ø 40 mm Mushroom Ø 40 mm

Anahtarlı Tip Butonlar / Key Operated Type Buttons

AA20	Anahtarlı, 2 Pozisyonlu, kalıcı (0-1) ∇ Key Operated, 2 Position, Stay - Put (0-1)
AA21	Anahtarlı, 2 Pozisyonlu, dönüşlü (0-1) ∇ Key Operated, 2 Position, Spring Return (0-1)
AA30	Anahtarlı, 3 Pozisyonlu, kalıcı (II-0-I) ∇ Key Operated, 3 Position, Stay - Put (II-0-I)
AA31	Anahtarlı, 3 Pozisyonlu, tek dönüşlü (II-0-I) ∇ Key Operated, 3 Position, Single Spring Return (II-0-I)
AA32	Anahtarlı, 3 Pozisyonlu, çift dönüşlü (II-0-I) ∇ Key Operated, 3 Position, Double Spring Return (II-0-I)
AC20	Anahtarlı, 2 Pozisyonlu, kalıcı (II-0-I) ∇ Key Operated, 2 Position, Stay - Put (II-0-I)
AC30	Anahtarlı, 3 Pozisyonlu, kalıcı (II-0-I) ∇ Key Operated, 3 Position, Stay - Put (II-0-I)

∇ Anahtarın çıkarılabildiği pozisyon
Taking key out position

Seçici Tip Butonlar / Selector Switch Type Buttons

S20	Seçici, 2 Pozisyonlu, Kalıcı (0-1), 60° Selector Switch, 2 Position, Stay - Put (0-1), 60°
S21	Seçici, 2 Pozisyonlu, Dönüşlü (0-1), 60° Selector Switch, 2 Position, Spring Return (0-1), 60°
S30	Seçici, 3 Pozisyonlu, Kalıcı (II-0-I), 60° Selector Switch, 3 Position, Stay - Put (II-0-I), 60°
S31	Seçici, 3 Pozisyonlu, Tek Dönüşlü (II-0-I), 60° Selector Switch, 3 Position, Single Spring Return (II-0-I), 60°
S32	Seçici, 3 Pozisyonlu, Çift Dönüşlü (II-0-I), 60° Selector Switch, 3 Position, Double Spring Return (II-0-I), 60°

Joyistik Tip Butonlar / Joystick

DJ20	Joyistik, 2 Pozisyonlu, Kalıcı Joystick, 2 Position, Stay - Put
DJ21	Joyistik, 2 Pozisyonlu, Dönüşlü Joystick, 2 Position, Spring Return
DJ30	Joyistik, 4 Pozisyonlu, Kalıcı Joystick, 4 Position, Stay - Put
DJ31	Joyistik, 4 Pozisyonlu, Dönüşlü Joystick, 4 Position, Spring Return

Şoklu Tip Acil Stop Butonları (Sadece CP Plastik Serisi için)

Emergency Stop Buttons, Twist On/Release On (Only For CP Plastic Series)

E30	Acil Stop Ø 30 mm, Çevirmeli Şoklu* Emergency Stop Ø 30 mm, Twist On
EA30	Acil Stop Ø 30 mm, Anahtarlı, Çevirmeli Şoklu* Emergency Stop Ø 30 mm, Twist On, Key Operated
ES30	Acil Stop Ø 30 mm, Sinyalli, Çevirmeli Şoklu* Emergency Stop Ø 30 mm, With Signal
ECN30	Acil Stop Ø 30 mm, Çekmeli Şoklu* Emergency Stop Ø 30 mm, Release On
ECS30	Acil Stop Ø 30 mm, Sinyalli, Çekmeli Şoklu* Emergency Stop Ø 30 mm, With Signal, Release On
CPDE	Acil Stop Ø 40 mm, Çevirmeli Şoklu Emergency Stop Ø 40 mm, Twist On
CPDEP	Acil Stop Ø 40 mm, Pencereli Emergency Stop Ø 40 mm, With Window

* Ani Kilitlemeli
* Sudden Locking

Çiftli Butonlar / Double Head Buttons

K20	Çiftli, Düz Kafalı Double, Spring Return
K21	Çiftli, 1 Çıkık Kafalı Double, 1 Extended
X	Sinyal Signal

Buton Rengi Button Colour

B	Beyaz White
K	Kırmızı Red
M	Mavi Blue
S	Sarı Yellow
Y	Yeşil Green
H	Siyah Mat Black Mat

Işık Bloğu Tipi Illumination Block Type

O	Baş Without Illumination
B	100-230 V AC/DC Beyaz Ledli 100-230 V AC/DC With White Led
K	100-230 V AC/DC Kırmızı Ledli 100-230 V AC/DC With Red Led
M	100-230 V AC/DC Mavi Ledli 100-230 V AC/DC With Blue Led
S	100-230 V AC/DC Sarı Ledli 100-230 V AC/DC With Yellow Led
Y	100-230 V AC/DC Yeşil Ledli 100-230 V AC/DC With Green Led
5	12-30 V AC/DC Beyaz Ledli 12-30 V AC/DC With White Led
6	12-30 V AC/DC Kırmızı Ledli 12-30 V AC/DC With Red Led
7	12-30 V AC/DC Mavi Ledli 12-30 V AC/DC With Blue Led
8	12-30 V AC/DC Sarı Ledli 12-30 V AC/DC With Yellow Led
9	12-30 V AC/DC Yeşil Ledli 12-30 V AC/DC With Green Led
Q	Özel Gerilim Beyaz Ledli Special Voltage With White Led
X	Özel Gerilim Kırmızı Ledli Special Voltage With Red Led
V	Özel Gerilim Mavi Ledli Special Voltage With Blue Led
W	Özel Gerilim Sarı Ledli Special Voltage With Yellow Led
Z	Özel Gerilim Yeşil Ledli Special Voltage With Green Led

0 Baş
Without Contact Block

1 Start - Butonluk
Start - For Button

2 Stop - Butonluk
Stop - For Button

3 Yanyana Start - Start
Start - Start Tandem

4 Yanyana Start - Stop
Start - Stop Tandem

5 Yanyana Stop - Stop
Stop - Stop Tandem

6 Start - Start Düşey
Start - Start Vertical

7 Start - Stop Tek Kontakta
Start - Stop at One Contact

8 Stop - Stop Düşey
Stop - Stop Vertical

9 Start - Stop Düşey
Start - Stop Vertical

Örnek: CM1K2DK → Örnek olarak CM metal serisi, start-stop, 100-230 V AC/DC kırmızı ledli, kırmızı renkli, düz, yuvarlak yaylı buton seçilmiştir.

Example: CM1K2DK → CM series, start-stop, 100-230 V AC/DC with red led, red, round type button has been selected.

Kumanda Butonları ve Sinyal Lambaları

Push Buttons and Signal Lamps

C Serisi Ø 22 mm Adaptörlü Kumanda Butonu Tipleri

Series Ø 22 mm Push Buttons With Adapter

Sipariş Kodu Order Code	Kontakt Blok Tipi Contact Block Type		Işık* Illumination	Buton Tipi Button Type	Renk Colour
	Normal Açık Normally Open	Normal Kapalı Normally Closed			
CP100DB	1	-	✓	✓	Beyaz / White
CP100DK	1	-	✓	✓	Kırmızı / Red
CP100DM	1	-	✓	✓	Mavi / Blue
CP100DS	1	-	✓	✓	Sarı / Yellow
CP100DY	1	-	✓	✓	Yeşil / Green
CP100DH	1	-	-	✓	Siyah / Black
CP101DB	2	-	✓	✓	Beyaz / White
CP101DK	2	-	✓	✓	Kırmızı / Red
CP101DM	2	-	✓	✓	Mavi / Blue
CP101DS	2	-	✓	✓	Sarı / Yellow
CP101DY	2	-	✓	✓	Yeşil / Green
CP101DH	2	-	-	✓	Siyah / Black
CP102DB	1	1	✓	✓	Beyaz / White
CP102DK	1	1	✓	✓	Kırmızı / Red
CP102DM	1	1	✓	✓	Mavi / Blue
CP102DS	1	1	✓	✓	Sarı / Yellow
CP102DY	1	1	✓	✓	Yeşil / Green
CP102DH	1	1	-	✓	Siyah / Black
CP200DB	-	1	✓	✓	Beyaz / White
CP200DK	-	1	✓	✓	Kırmızı / Red
CP200DM	-	1	✓	✓	Mavi / Blue
CP200DS	-	1	✓	✓	Sarı / Yellow
CP200DY	-	1	✓	✓	Yeşil / Green
CP200DH	-	1	-	✓	Siyah / Black
CP202DB	-	2	✓	✓	Beyaz / White
CP202DK	-	2	✓	✓	Kırmızı / Red
CP202DM	-	2	✓	✓	Mavi / Blue
CP202DS	-	2	✓	✓	Sarı / Yellow
CP202DY	-	2	✓	✓	Yeşil / Green
CP202DH	-	2	-	✓	Siyah / Black
CM100DB	1	-	✓	✓	Beyaz / White
CM100DK	1	-	✓	✓	Kırmızı / Red
CM100DM	1	-	✓	✓	Mavi / Blue
CM100DS	1	-	✓	✓	Sarı / Yellow
CM100DY	1	-	✓	✓	Yeşil / Green
CM100DH	1	-	-	✓	Siyah / Black
CM101DB	2	-	✓	✓	Beyaz / White
CM101DK	2	-	✓	✓	Kırmızı / Red
CM101DM	2	-	✓	✓	Mavi / Blue
CM101DS	2	-	✓	✓	Sarı / Yellow
CM101DY	2	-	✓	✓	Yeşil / Green
CM101DH	2	-	-	✓	Siyah / Black
CM102DB	1	1	✓	✓	Beyaz / White
CM102DK	1	1	✓	✓	Kırmızı / Red
CM102DM	1	1	✓	✓	Mavi / Blue
CM102DS	1	1	✓	✓	Sarı / Yellow
CM102DY	1	1	✓	✓	Yeşil / Green
CM102DH	1	1	-	✓	Siyah / Black
CM200DB	-	1	✓	✓	Beyaz / White
CM200DK	-	1	✓	✓	Kırmızı / Red
CM200DM	-	1	✓	✓	Mavi / Blue
CM200DS	-	1	✓	✓	Sarı / Yellow
CM200DY	-	1	✓	✓	Yeşil / Green
CM200DH	-	1	-	✓	Siyah / Black
CM202DB	-	2	✓	✓	Beyaz / White
CM202DK	-	2	✓	✓	Kırmızı / Red
CM202DM	-	2	✓	✓	Mavi / Blue
CM202DS	-	2	✓	✓	Sarı / Yellow
CM202DY	-	2	✓	✓	Yeşil / Green
CM202DH	-	2	-	✓	Siyah / Black



CP100DM
Düz Kafalı Yaylı Buton
Flush, Spring Return



CP100DK
Düz Kafalı Yaylı Buton
Flush, Spring Return



CP305DY
Düz Metal Kafalı Yaylı Buton
(2NA+2NA)
Round Push Button With Spring
and With Metallic Construction (2N0+2N0)



CM100DS
Düz Metal Kafalı Yaylı Buton
Round Push Button With Spring
and With Metallic Construction



CM100DB
Düz Metal Kafalı Yaylı Buton
Round Push Button With Spring
and With Metallic Construction

*: Işık Bloğu seçenekleri için bakınız sayfa 23 Kumanda Butonları Seçim Tablosu

*: See page 23 for illumination block selection - Push Buttons Selection Table

C Serisi Ø 22 mm Adaptörlü Kumanda Butonu Tipleri

Series Ø 22 mm Push Buttons With Adapter



CP200E30
Ø 30 mm Şoklu Tip Acil Stop Butonu
Emergency Stop Ø 30 mm, Twist On/
Release On



CP200EA30
Ø 30 mm Şoklu Tip
Acil Stop Butonu
Emergency Stop Ø 30 mm,
Twist On/Release On



CM101DJ20
Joyistik Metal Kafalı Buton
Joystick Button With Metal Construction



CP102K20KY
Çiftli Düz Kafalı Yaylı Buton
Double, Spring Return



CM102K20HB
Çiftli Düz Metal Kafalı Yaylı Buton
Double Head Push Button
With Metal Construction

Sipariş Kodu Order Code	Kontakt Blok Tipi Contact Block Type		Buton Tipi Button Type		Renk Colour
	Normal Açık Normally Open	Normal Kapalı Normally Closed	Sinyalli* With Signal*	Anahtarlı With Key	
CP200E30	-	1	-	-	Kırmızı / Red
CP102E30	1	1	-	-	Kırmızı / Red
CP100E30	1	-	-	-	Kırmızı / Red
CP200EA30	-	1	-	✓	Kırmızı / Red
CP200ES30	-	1	✓*	-	Kırmızı / Red
CP200ECN30	-	1	-	-	Kırmızı / Red
CP200ECS30	-	1	✓*	-	Kırmızı / Red
CP200E	-	1	-	-	Kırmızı / Red
CP200EP	-	1	-	-	Kırmızı / Red
CM200E	-	1	-	-	Kırmızı / Red
CM200M	-	1	-	-	Kırmızı / Red

*: Standart olarak sinyal için kırmızı renkli led kullanılır, bkz. sayfa 23

*: See page 23, for signal standard colour is red

* Işık kontak bloğu dahil değil / Except illumination contact block

Not : C serisi acil stop butonları ani kilitlemelidir (Şoklu Tip)

Note: C series emergency stop buttons have sudden locking feature (Twist On/Release On)

Sipariş Kodu Order Code	Kontakt Blok Tipi Contact Block Type		Pozisyon Position
	Normal Açık Normally Open	Normal Kapalı Normally Closed	
CP101DJ20	2	-	2 Pozisyon-Kalıcılı 2 Position-Stay-Put
CP101DJ21	2	-	2 Pozisyon-Dönüşlü 2 Position-Spring Return
CP707DJ40	4	-	4 Pozisyon-Kalıcılı 4 Position-Stay-Put
CP707DJ41	4	-	4 Pozisyon-Dönüşlü 4 Position-Spring Return
CM101DJ20	2	-	2 Pozisyon-Kalıcılı 2 Position-Stay-Put
CM101DJ21	2	-	2 Pozisyon-Dönüşlü 2 Position-Spring Return
CM707DJ40	4	-	4 Pozisyon-Kalıcılı 4 Position-Stay-Put
CM707DJ41	4	-	4 Pozisyon-Dönüşlü 4 Position-Spring Return



CP707DJ40
Joyistik Kafalı Buton
Joystick Button

Sipariş Kodu Order Code	Kontakt Blok Tipi Contact Block Type		Işık* Illumination	Buton Tipi Button Type	Renk Colour
	Normal Açık Normally Open	Normal Kapalı Normally Closed			
CP102K20KY	1	1	✓	Düz Standard	Kırmızı / Yeşil-Mat Red / Green-Mat
CP102K20HB	1	1	✓	✓	Siyah / Beyaz-Mat Black / White-Mat
CP102K21KY	1	1	✓	✓	Kırmızı / Yeşil Red / Green
CP102K21HB	1	1	✓	✓	Siyah / Beyaz Black / White
CM102K20KY	1	1	✓	✓	Kırmızı / Yeşil-Mat Red / Green-Mat
CM102K20HB	1	1	✓	✓	Siyah / Beyaz-Mat Black / White-Mat
CM102K21KY	1	1	✓	✓	Kırmızı / Yeşil Red / Green
CM102K21HB	1	1	✓	✓	Siyah / Beyaz Black / White

*: Işık Bloğu seçenekleri için bakınız sayfa 23 Kumanda Butonları Seçim Tablosu

*: See page 23 for illumination block selection - Push Buttons Selection Table

Kumanda Butonları ve Sinyal Lambaları

Push Buttons and Signal Lamps

C Serisi Ø 22 mm Adaptörlü Kumanda Butonu Tipleri

Series Ø 22 mm Push Buttons With Adapter

Sipariş Kodu Order Code	Kontakt Blok Tipi Contact Block Type		Işık* Illumination	Etiket Button Plates	Pozisyon Position
	Normal Açık Normally Open	Normal Kapalı Normally Closed			
CP100AA20	1	-	✓	O-I	2 Pozisyon-Kalıcılı 2 Position-Stay-Put
CP101AA21	1	-	✓	O-I	2 Pozisyon-Dönümlü 2 Position-Spring Return
CP101AA31	2	-	✓	II-O-I	3 Pozisyon-Tek Dönümlü 3 Position-Single Spring Return
CP101AA32	2	-	✓	II-O-I	3 Pozisyon-Çift Dönümlü 3 Position-Double Spring Return
CP102AA30	1	1	✓	II-O-I	3 Pozisyon-Kalıcılı 3 Position-Stay-Put
CP100AC20	1	-	✓	O-I	2 Pozisyon-Kalıcılı 2 Position-Stay-Put
CP102AC30	1	1	✓	II-O-I	3 Pozisyon-Kalıcılı 3 Position-Stay-Put
CM100AA20	1	-	✓	O-I	2 Pozisyon-Kalıcılı 2 Position-Stay-Put
CM100AA21	1	-	✓	O-I	2 Pozisyon-Dönümlü 2 Position-Spring Return
CM101AA31	2	-	✓	II-O-I	3 Pozisyon-Tek Dönümlü 3 Position-Single Spring Return
CM101AA32	2	-	✓	II-O-I	3 Pozisyon-Çift Dönümlü 3 Position-Double Spring Return
CM102AA20	1	1	✓	O-I	2 Pozisyon-Kalıcılı 2 Position-Stay-Put
CM102AA30	1	1	✓	II-O-I	3 Pozisyon-Kalıcılı 3 Position-Stay-Put
CM100AC20	1	-	✓	O-I	2 Pozisyon-Kalıcılı 2 Position-Stay-Put
CM102AC20	1	1	✓	O-I	2 Pozisyon-Kalıcılı 2 Position-Stay-Put
CM102AC30	1	1	✓	II-O-I	3 Pozisyon-Kalıcılı 3 Position-Stay-Put



CP100AC20
Anahtarlı Buton
Key Operated Button



CM100AC20
Anahtarlı Buton
Key Operated Button



CM101S30
Metal Kafalı Seçici Buton II-O-I
Selector Switch With Metal Construction



CP100S20
Seçici Buton O-I
Selector Switch



CP305S30
Seçici Buton II-O-I (2NA+2NK)
Selector Switch (2NO+2NC)



CP080XS
Sinyal Lambası Ø 22 mm
Signal Lamp Ø 22 mm

Sipariş Kodu Order Code	Kontakt Blok Tipi Contact Block Type		Işık* Illumination	Etiket Button Plates	Pozisyon Position
	Normal Açık Normally Open	Normal Kapalı Normally Closed			
CP100S20	1	-	✓	O-I	2 Pozisyon-Kalıcılı 2 Position-Stay-Put
CP101S30	2	-	✓	II-O-I	3 Pozisyon-Kalıcılı 3 Position-Stay-Put
CM100S20	1	-	✓	O-I	2 Pozisyon-Kalıcılı 2 Position-Stay-Put
CM101S30	2	-	✓	II-O-I	3 Pozisyon-Kalıcılı 3 Position-Stay-Put
CP100S21	1	-	✓	O-I	2 Pozisyon-Dönümlü 2 Position-Spring Return
CP101S31	2	-	✓	II-O-I	3 Pozisyon-Tek Dönümlü 3 Position-Single Spring Return
CP101S32	2	-	✓	II-O-I	3 Pozisyon-Çift Dönümlü 3 Position-Double Spring Return
CM100S21	1	-	✓	O-I	2 Pozisyon-Dönümlü 2 Position-Spring Return
CM101S31	2	-	✓	II-O-I	3 Pozisyon-Tek Dönümlü 3 Position-Single Spring Return
CM101S32	2	-	✓	II-O-I	3 Pozisyon-Çift Dönümlü 3 Position-Double Spring Return
CP303S30	2	2	✓	II-O-I	3 Pozisyon-Kalıcılı 3 Position-Stay-Put
CP305S30	2	2	✓	II-O-I	3 Pozisyon-Kalıcılı 3 Position-Stay-Put
CM303S30	2	2	✓	II-O-I	3 Pozisyon-Kalıcılı 3 Position-Stay-Put

*: Işık Bloğu seçenekleri için bakınız sayfa 22 Kumanda Butonları Seçim Tablosu

*: See page 22 for illumination block selection - Push Buttons Selection Table

Sipariş Kodu Order Code	Işık* Illumination	Nominal Gerilim Nominal Voltage	Renk Colour
	Led dahil / With led		
CP050XB	1	12-30 V AC/DC	Beyaz / White
CP060XK	1	12-30 V AC/DC	Kırmızı / Red
CP070XM	1	12-30 V AC/DC	Mavi / Blue
CP080XS	1	12-30 V AC/DC	Sarı / Yellow
CP090XY	1	12-30 V AC/DC	Yeşil / Green
CPOB0XB	1	100-230 V AC	Beyaz / White
CPOK0XK	1	100-230 V AC	Kırmızı / Red
CPOM0XM	1	100-230 V AC	Mavi / Blue
CPOS0XS	1	100-230 V AC	Sarı / Yellow
CP0Y0XY	1	100-230 V AC	Yeşil / Green



CM060XK

Metal Kafalı Sinyal Lambası Ø 22 mm
Signal Lamp Ø 22 mm With Metal
Construction

Sipariş Kodu Order Code	Işık* Illumination	Nominal Gerilim Nominal Voltage	Renk Colour
	Led dahil / With led		
CM050XB	1	12-30 V AC/DC	Beyaz / White
CM060XK	1	12-30 V AC/DC	Kırmızı / Red
CM070XM	1	12-30 V AC/DC	Mavi / Blue
CM080XS	1	12-30 V AC/DC	Sarı / Yellow
CM090XY	1	12-30 V AC/DC	Yeşil / Green
CM0BOXB	1	100- 230 V AC	Beyaz / White
CM0K0XK	1	100- 230 V AC	Kırmızı / Red
CM0M0XM	1	100- 230 V AC	Mavi / Blue
CM0S0XS	1	100-230 V AC	Sarı / Yellow
CM0Y0XY	1	100-230 V AC	Yeşil / Green

*: Işık Bloğu seçenekleri için bakınız sayfa 20 Kumanda Butonları Seçim Tablosu

*: See page 20 for illumination block selection - Push Buttons Selection Table

C Serisi Kontak Bloklar ve Işık Blokları

Contact Block Types For C Series Ø 22 mm Push Buttons With Adapter

C SERİSİ BUTONLUK / C SERIES FOR BUTTONS



C1

C Serisi Butonluk
Kontakt Blok Start-Stop
C Series For Button
Contact Block Start-Stop

C2



CBM

C Serisi Butonluk Ledli Blok
C Series For Button
Illumination Block With Led

Sipariş Kodu Order Code	Kontakt Blok Tipi Contact Block Type		Işık* Illumination	Nominal Akım Nominal Current	Nominal Gerilim Nominal Voltage	Renk Colour
	Normal Açık Normally Open	Normal Kapalı Normally Closed				
C1	1	-	-	4A	250 V	-
C1AU	1	-	-	4A	250 V	-
C2	-	1	-	4A	250 V	-
C2AU	1	-	-	4A	250 V	-
C12	1	1	-	4A	250 V	-
CB5	-	-	1	5-15mA	12-30 V AC/DC	Beyaz / White
CB6	-	-	1	5-15mA	12-30 V AC/DC	Kırmızı / Red
CB7	-	-	1	5-15mA	12-30 V AC/DC	Mavi / Blue
CB8	-	-	1	5-15mA	12-30 V AC/DC	Sarı / Yellow
CB9	-	-	1	5-15mA	12-30 V AC/DC	Yeşil / Green
CBB	-	-	1	2-5mA	100-230 V AC	Beyaz / White
CBK	-	-	1	2-5mA	100-230 V AC	Kırmızı / Red
CBM	-	-	1	2-5mA	100-230 V AC	Mavi / Blue
CBS	-	-	1	2-5mA	100-230 V AC	Sarı / Yellow
CBY	-	-	1	2-5mA	100-230 V AC	Yeşil / Green
CBB-4	-	-	1	4-5mA	110 V AC/DC	Beyaz / White
CBK-4	-	-	1	4-5mA	110 V AC/DC	Kırmızı / Red
CBM-4	-	-	1	4-5mA	110 V AC/DC	Mavi / Blue
CBS-4	-	-	1	4-5mA	110 V AC/DC	Sarı / Yellow
CBY-4	-	-	1	4-5mA	110 V AC/DC	Yeşil / Green

Not : Maksimum 3 adet kontak blok arka arkaya eklenebilir. / Note: Max. 3 contact blocks can be added subsequently.

Not : C1AU , C2AU Altın kaplamalı kontak blok. / Note: C1AU , C2AU gold plated contact block.

Not : C12, Joystic kontak blok. / Note: C12, Joystic contact block.

C SERİSİ KUTULUK / C SERIES FOR BOXES



C3

C Serisi Kutuluk
Kontakt Blok Start-Stop
C Series For Box
Contact Block Start-Stop

C4



CKM

C Serisi Kutuluk Ledli Blok
C Series For Box
Illumination Block With Led

Sipariş Kodu Order Code	Kontakt Blok Tipi Contact Block Type		Işık* Illumination	Nominal Akım Nominal Current	Nominal Gerilim Nominal Voltage	Renk Colour
	Normal Açık Normally Open	Normal Kapalı Normally Closed				
C3	1	-	-	4A	250 V	-
C4	-	1	-	4A	250 V	-
C3CK	1	-	-	4A	250 V	-
C4CK	-	1	-	4A	250 V	-
C3BK	1	-	-	4A	250 V	-
C4BK	-	1	-	4A	250 V	-
CK5	-	-	1	5-15mA	12-30 V AC/DC	Beyaz / White
CK6	-	-	1	5-15mA	12-30 V AC/DC	Kırmızı / Red
CK7	-	-	1	5-15mA	12-30 V AC/DC	Mavi / Blue
CK8	-	-	1	5-15mA	12-30 V AC/DC	Sarı / Yellow
CK9	-	-	1	5-15mA	12-30 V AC/DC	Yeşil / Green
CKB	-	-	1	2-5mA	100-230 V AC	Beyaz / White
CKK	-	-	1	2-5mA	100-230 V AC	Kırmızı / Red
CKM	-	-	1	2-5mA	100-230 V AC	Mavi / Blue
CKS	-	-	1	2-5mA	100-230 V AC	Sarı / Yellow
CKY	-	-	1	2-5mA	100-230 V AC	Yeşil / Green
CKB-4	-	-	1	4-5mA	110 V AC/DC	Beyaz / White
CKK-4	-	-	1	4-5mA	110 V AC/DC	Kırmızı / Red
CKM-4	-	-	1	4-5mA	110 V AC/DC	Mavi / Blue
CKS-4	-	-	1	4-5mA	110 V AC/DC	Sarı / Yellow
CKY-4	-	-	1	4-5mA	110 V AC/DC	Yeşil / Green

Kumanda Butonları ve Sinyal Lambaları

Push Buttons and Signal Lamps

AKSESUARLAR / ACCESSORIES

Sipariş Kodu Order Code	Malzeme Material	Renk Colour
CMB	Metal / Metal	Sarı / Yellow
B-ROZET08	Plastik / Plastic	Siyah / Black
B-ROZET18	Plastik / Plastic	Siyah / Black
B-MUHAFAZA	Plastik / Plastic	Sarı / Yellow



CMB
Montaj Bileziği
Mounting Bracelet



BET60P
(Plastik / Plastic)
BET60A
(Alüminyum / Aluminium)
Etiket Ø 60 mm Acil Stop
Plate Ø 60 mm Emergency Stop



BET90P
(Plastik / Plastic)
BET90A
(Alüminyum / Aluminium)
Etiket Ø 90 mm Acil Stop
Plate Ø 90 mm Emergency Stop



B-MUHAFAZA
Emniyet Basma Düğmesi
Darbe Muhafazası
Emergency Push Button
Plate Protection



B-ROZET18
Rozet 18 mm
Badge Base 18 mm



B-ROZET08
Rozet 8 mm
Badge Base 8 mm

Sipariş Kodu Order Code	Etiket Yazısı Plate	Renk Colour
BET08	-	Gri / Grey
BET18	-	Gri / Grey
BET08-START	START	Gri / Grey
BET08-STOP	STOP	Gri / Grey
BET08-01	O-I	Gri / Grey
BET08-010K	O-I	Gri / Grey
BET08-201	II-O-I	Gri / Grey
BET08-2010K	II-O-I	Gri / Grey
BET08-2010K2	II-O-I	Gri / Grey
BET60P	EMERGENCY STOP	Sarı / Yellow - Plastik / Plastic
BET90P	EMERGENCY STOP	Sarı / Yellow - Plastik / Plastic
BET60A	EMERGENCY STOP	Sarı / Yellow - Alüminyum / Aluminium
BET90A	EMERGENCY STOP	Sarı / Yellow - Alüminyum / Aluminium



BET18
Etiket 18 mm Boş
Plate 18 mm Empty



BET08
Etiket 8 mm Boş
Plate 8 mm Empty



BET08-START
Etiket 8 mm START
Plate 8 mm START



BET08-2010K2
Etiket 8 mm II-O-I
Plate 8 mm II-O-I



BET08-2010K
Etiket 8 mm
Plate 8 mm



BET08-201
Etiket 8 mm II-O-I
Plate 8 mm II-O-I



BET08-010K
Etiket 8 mm O-I
Plate 8 mm O-I



BET08-01
Etiket 8 mm O-I
Plate 8 mm O-I



BET08-STOP
Etiket 8 mm STOP
Plate 8 mm STOP

MONTAJ ŞEKLİ / ASSEMBLY

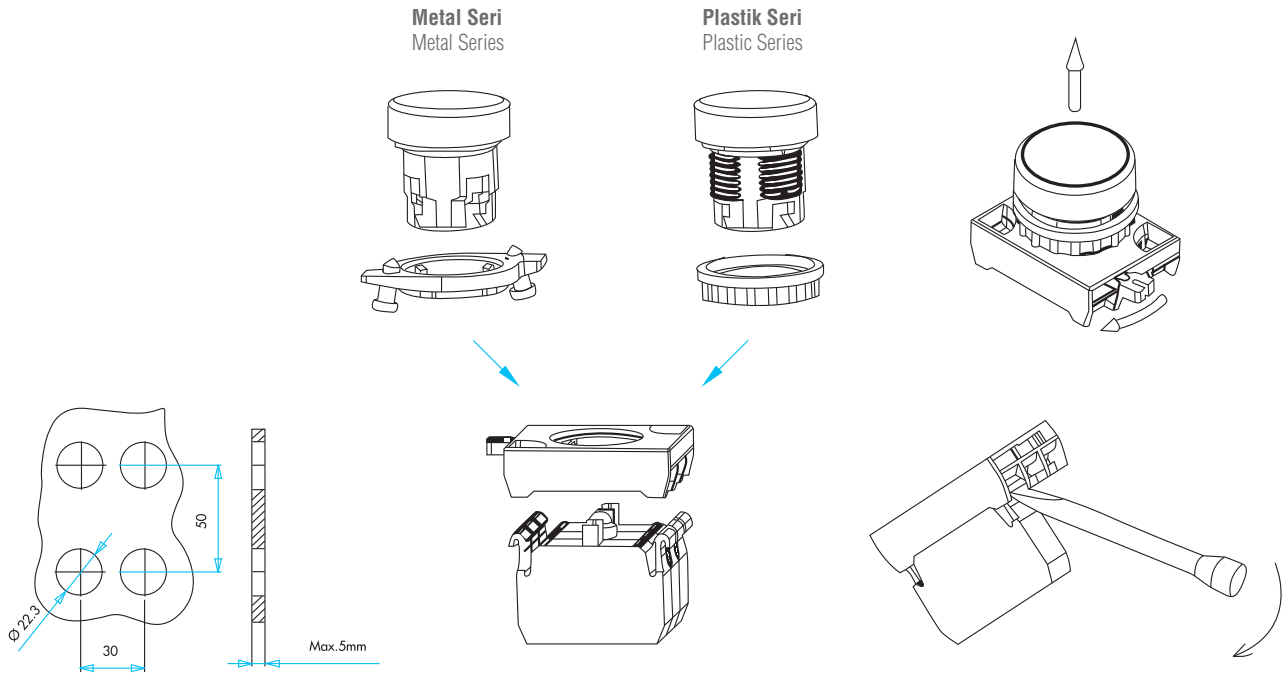

Emniyet ve mantar butonlarında 30 mm ölçüsü 45 mm'dir.
30 mm size is 45 mm in emergency and mushroom buttons.

BOYUTLAR (mm) / DIMENSIONS (mm)

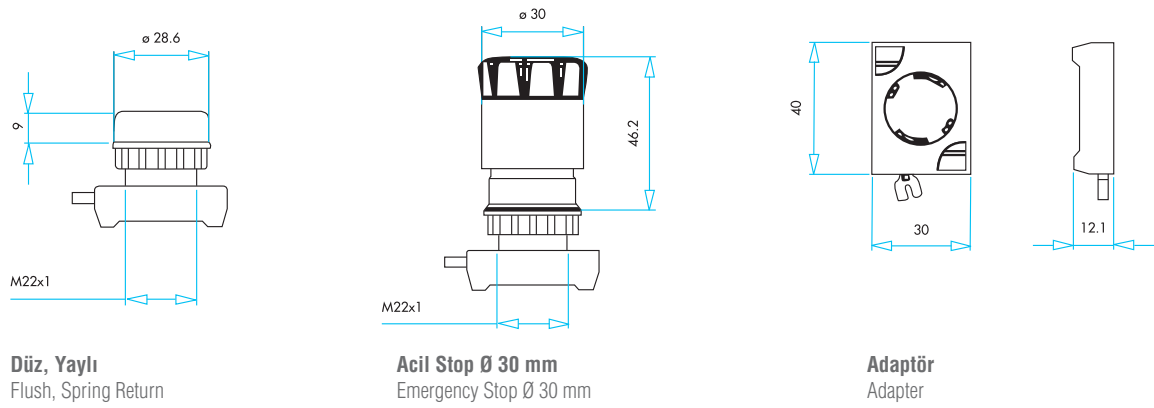

Kumanda Butonları ve Sinyal Lambaları

Push Buttons and Signal Lamps

BOYUTLAR (mm) / DIMENSIONS (mm)

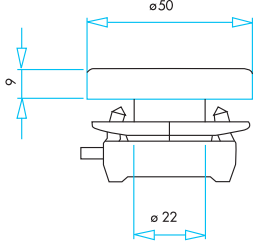

Çiftli Düz Kafalı, Yaylı
Double, Spring Return

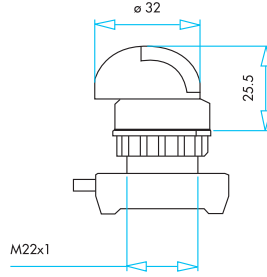

Seçici
Selector

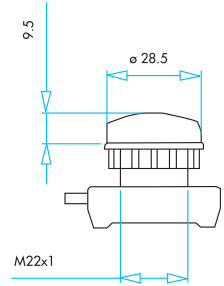

Sinyal
Signal

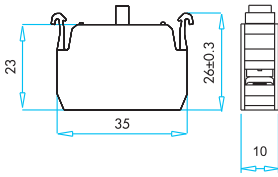

C Serisi Kontak
Blok-Butonluk
C Series Contact
Block-For Button

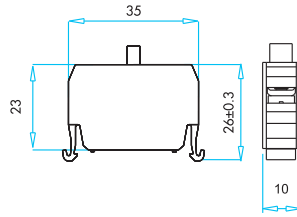

C Serisi Kontak
Blok-Kutuluk
C Series Contact
Block-For Box

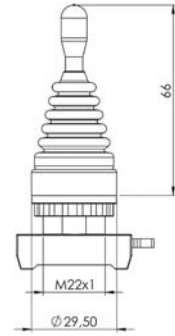

Joyistik
Joystick

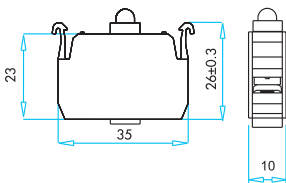

C Serisi Ledli
Işıklı Blok-Butonluk
C Series Illumination
Block With Led-For Button

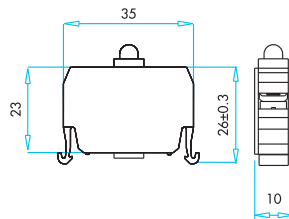

C Serisi Ledli
Işıklı Blok-Kutuluk
C Series Illumination
Block With Led-For Box

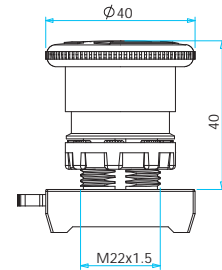

CP/CM Anahtarlı 40mm
CP 40mm Acil Emniyet
CP/CM Key Operated 40mm
CP 40mm Emergency