

SPECIFICATION

Customer: _____
Model Name: SAT070HS40D21Y0-351001
SPEC NO.: _____
Date: _____
Version: _____

Preliminary Specification
 Final Specification

Approved by	Comment

Approved by	Reviewed by	Prepared by
		

Record of Revision

Version	Revise Date	Page	Content
Pre-spec.A	2014/08/25		Initial Release

视安通集团 SAT GROUP

Contents

1. General Specifications	4
2. Pin Assignment	5
3. Operation Specifications	8
3.1. Absolute Maximum Rating	8
3.1.1. Typical Operation Conditions	9
3.1.2. Current Consumption	9
3.1.3. Backlight Driving Conditions	10
3.2. Power Sequence	11
3.3. Timing Characteristics	12
3.3.1. AC Electrical Characteristics	12
3.3.2. Data Input Format	13
3.3.3. Timing	14
4. Optical Specifications	15
5. Reliability Test Items	19
6. General Precautions	20
6.1. Safety	20
6.2. Handling	20
6.3. Static Electricity	20
6.4. Storage	20
6.5. Cleaning	20
7. Mechanical Drawing	21
8. Package Drawing	22
9. Product ID Rule	23

1. General Specifications

No.	Item	Specification	Remark
1	LCD size	7.0 inch(Diagonal)	
2	Driver element	a-Si TFT active matrix	
3	Resolution	800 × 3(RGB) × 480	
4	Display mode	Normally White, Transmissive	
5	Pixel pitch	0.192(H) X 0.1805(V) mm	
6	Active area	153.6(H) X 3(RGB) X 86.64(V) mm	
7	Outline dimensions	165(H) X 100(V) X 3.5(D) mm	
8	Surface treatment	Anti-Glare	
9	Color arrangement	RGB-stripe	
10	Interface	TTL RGB-24bit parallel interface	
11	Backlight Power consumption	TBD	
12	Panel Power consumption	TBD	
13	Weight	TBD	

2. Pin Assignment

FPC Connector is used for the module electronics interface. The recommended model is FH12A-40S-0.5SH manufactured by Hirose.

Pin No.	Symbol	I/O	Function	Remark
1	VLED-	P	Power for LED backlight(Cathode)	Note 6
2	VLED+	P	Power for LED backlight(anode)	Note 6
3	GND	P	Power ground	
4	VDD	P	Power supply(3.3V)	
5	R0	I	Red data	Note 2
6	R1	I	Red data	Note 2
7	R2	I	Red data	
8	R3	I	Red data	
9	R4	I	Red data	
10	R5	I	Red data	
11	R6	I	Red data	
12	R7	I	Red data	
13	G0	I	Green data	Note 2
14	G1	I	Green data	Note 2
15	G2	I	Green data	
16	G3	I	Green data	
17	G4	I	Green data	
18	G5	I	Green data	
19	G6	I	Green data	
20	G7	I	Green data	
21	B0	I	Blue data	Note 2
22	B1	I	Blue data	Note 2
23	B2	I	Blue data	
24	B3	I	Blue data	
25	B4	I	Blue data	
26	B5	I	Blue data	

27	B6	I	Blue data	
28	B7	I	Blue data	
29	GND	P	Power ground	
30	DOT CLK	I	Data clock	
31	DISP	I	Standby mode control pin	Note 7
32	HSYNC	I	Horizontal synchronous signal	Note 1
33	VSYNC	I	Vertical synchronous signal	Note 1
34	DEN	I	Data enabling signal	Note 1
35	NC	-	No Connect	
36	GND	P	Power ground	
37	XR	I/O	Right electrode-differential analog	
38	YD	I/O	Bottom electrode-differential analog	
39	XL	I/O	Left electrode-differential analog	
40	YU	I/O	Top electrode-differential analog	

I: input, O: output, P: Power

Note 1: DE/SYNC mode select. Normally pull high.

When select DE mode, R114=4.7K, R117=NC, VS and HS must pull high.

When select SYNC mode, R114=NC, R117=4.7K, DE must be grounded.

Note 2: When input 18 bits RGB data, the two low bits of R, G and B data must be grounded.

Note 3: Data shall be latched at the falling edge of DCLK.

Note 4: Selection of scanning mode

Setting of scan control input		Scanning direction
U/D	L/R	
R115=4.7K	R112=4.7K	Up to down, left to right
R113=4.7K	R116=4.7K	Down to up, right to left
R115=4.7K	R116=4.7K	Up to down, right to left
R113=4.7K	R112=4.7K	Down to up, left to right

Note 5: Definition of scanning direction.
Refer to the figure as below:

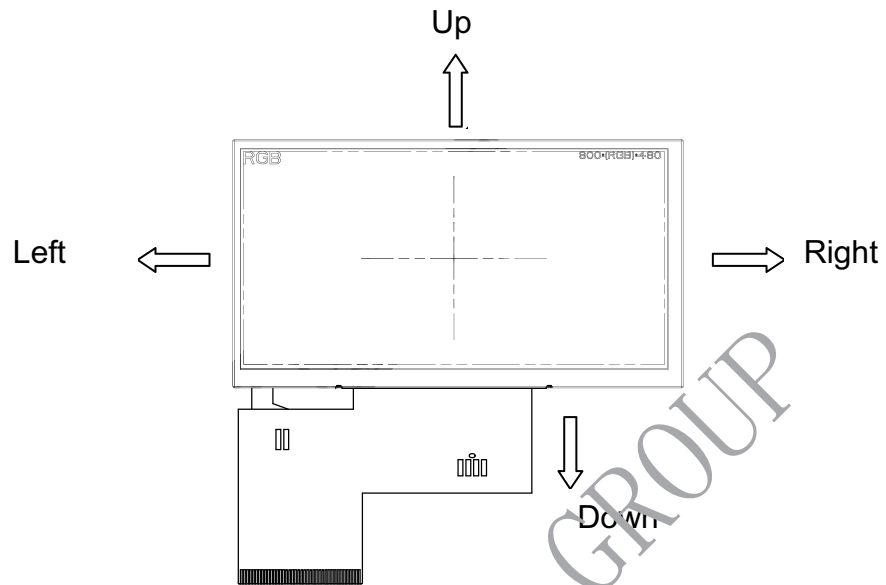

Note 6 : Reserve for LED power input

Note 7: Dithering function enable control, normally pull high.
When DISP="1",Disable internal dithering function,
When DISP="0",Enable internal dithering function,

3. Operation Specifications

3.1. Absolute Maximum Ratings

(Note 1)

Item	Symbol	Values		Unit	Remark
		Min.	Max.		
Power voltage	DV_{DD}	-0.3	3.96	V	
	AV_{DD}	-0.5	14.85	V	
	V_{GH}	-0.3	40.0	V	
	V_{GL}	-20.0	0.3	V	
	$V_{GH}-V_{GL}$	12	40.0	V	
Operation Temperature	T_{OP}	-20	70	°C	
Storage Temperature	T_{ST}	-30	80	°C	

Note 1: The absolute maximum rating values of this product are not allowed to be exceeded at any times. Should a module be used with any of the absolute maximum ratings exceeded, the characteristics of the module may not be recovered, or in an extreme case, the module may be permanently destroyed.

3.1.1. Typical Operation Conditions

(Note 1)

Item	Symbol	Values			Unit	Remark
		Min.	Typ.	Max.		
Power voltage	DV _{DD}	3.0	3.3	3.6	V	Note 2
	AV _{DD}	9.85	10	10.15	V	
	V _{GH}	14.5	15	15.5	V	
	V _{GL}	-7.5	-7.0	-6.5	V	
Input signal voltage	V _{COM}	3.22	3.72	4.22	V	
Input logic high voltage	V _{IH}	0.7 DV _{DD}	-	DV _{DD}	V	Note 3
Input logic low voltage	V _{IL}	0	-	0.3 DV _{DD}	V	

Note 1: Be sure to apply DV_{DD} and V_{GL} to the LCD first, and then apply V_{GH}.

Note 2: DV_{DD} setting should match the signals output voltage (refer to Note 3) of customer's system board.

Note 3: DCLK,HS,VS,RESET,U/D, L/R,DE,R0~R7,G0~G7,B0~B7,MODE,DITHB.

3.1.2. Current Consumption

Item	Symbol	Values			Unit	Remark
		Min.	Typ.	Max.		
Current for Driver	I _{GH}	-	0.2	1.0	mA	V _{GH} =15.0V
	I _{GL}	-	0.2	1.0	mA	V _{GL} = -7.0V
	IDV _{DD}	-	4.0	10	mA	DV _{DD} =3.3V
	IAV _{DD}	-	20	50	mA	AV _{DD} =10V

3.1.3. Backlight Driving Conditions (21 White Chips)

Parameter	Symbol	Min.	Typ.	Max.	Unit	Note
Supply voltage of white LED backlight	VL	8.7	9.6	10.5	V	Note 1
Curt for LED backlight	IL	105	140	175	mA	
Luminance (on the module surface, BM-7)		240	290	-	cd/m ²	
LED life time	-	20,000	-	-	Hr	Note 2

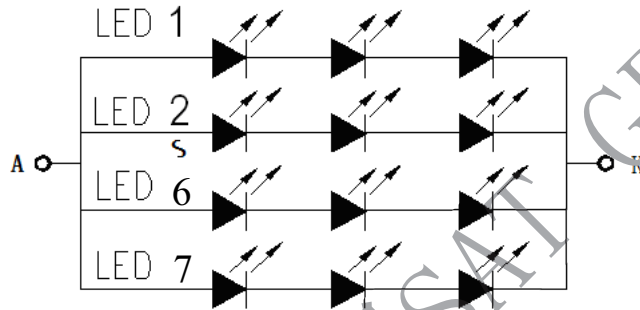

视安通集团 SAT GROUP

3.2. Power Sequence

To prevent the device damage from latch up, the power on/off sequence shown below must be followed.

Power ON: VDD, GND → AVDD, AVSS → V1 to V14

Power OFF: V1 to V14 → AVDD, AVSS → VDD, GND

Power on/off control

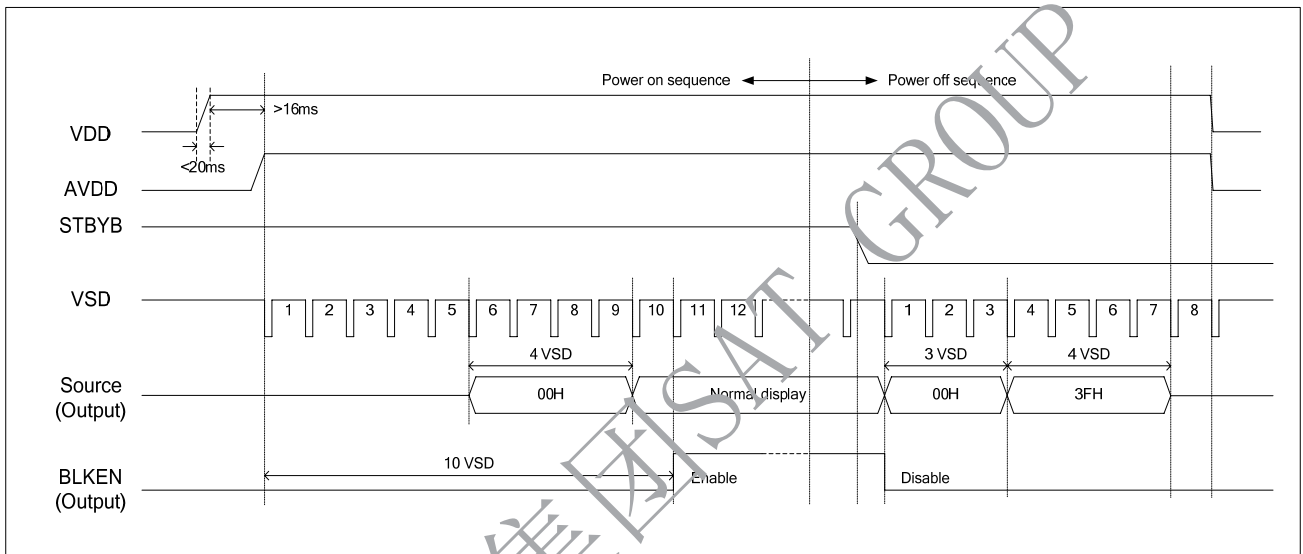

Figure 3.1: Power on/off timing sequence

Enter and exit standby mode sequence

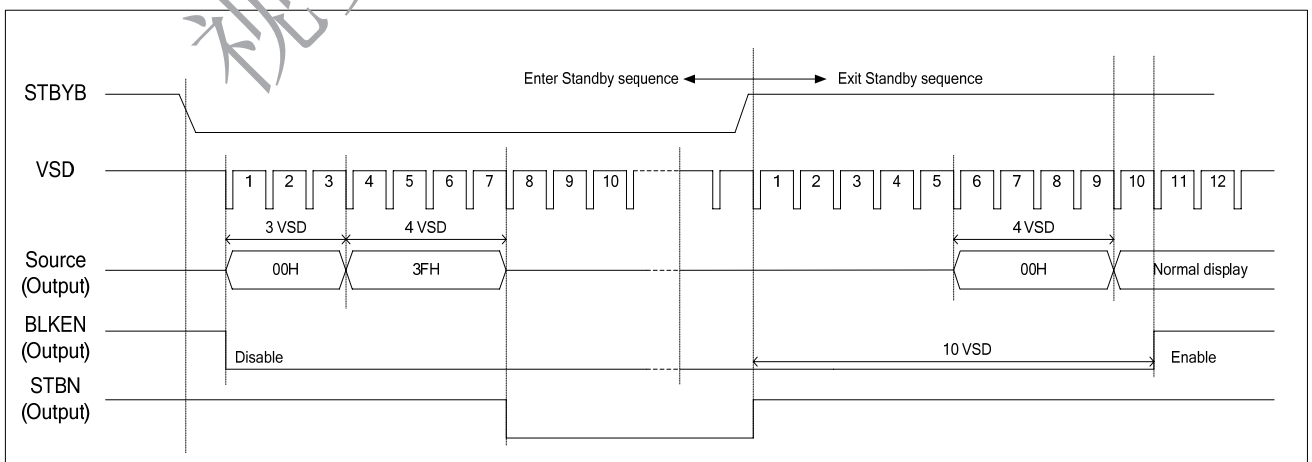

Figure 3.2: Enter and exit standby mode sequence

3.3. Timing Characteristics

3.3.1 AC electrical characteristics

Parameter	Symbol	Spec.			Unit
		Min.	Typ.	Max.	
HS setup time	T _{hst}	8	-	-	ns
HS hold time	T _{hhd}	8	-	-	ns
VS setup time	T _{vst}	8	-	-	ns
VS hold time	T _{vhd}	8	-	-	ns
Data setup time	T _{dsu}	8	-	-	ns
Data hold time	T _{dhd}	8	-	-	ns
DE setup time	T _{esu}	8	-	-	ns
DE hold time	T _{ehd}	8	-	-	ns
VDD Power On Slew rate	TPOR	-	-	20	ms
RSTB pulse width	TRst	10	-	-	μs
CLKIN cycle time	T _{cph}	20	-	-	ns
CLKIN pulse duty	T _{cwh}	40	50	60	%
Output stable time	T _{sst}	-	-	6	μs

3.3.2. Data Input Format

- Horizontal timing

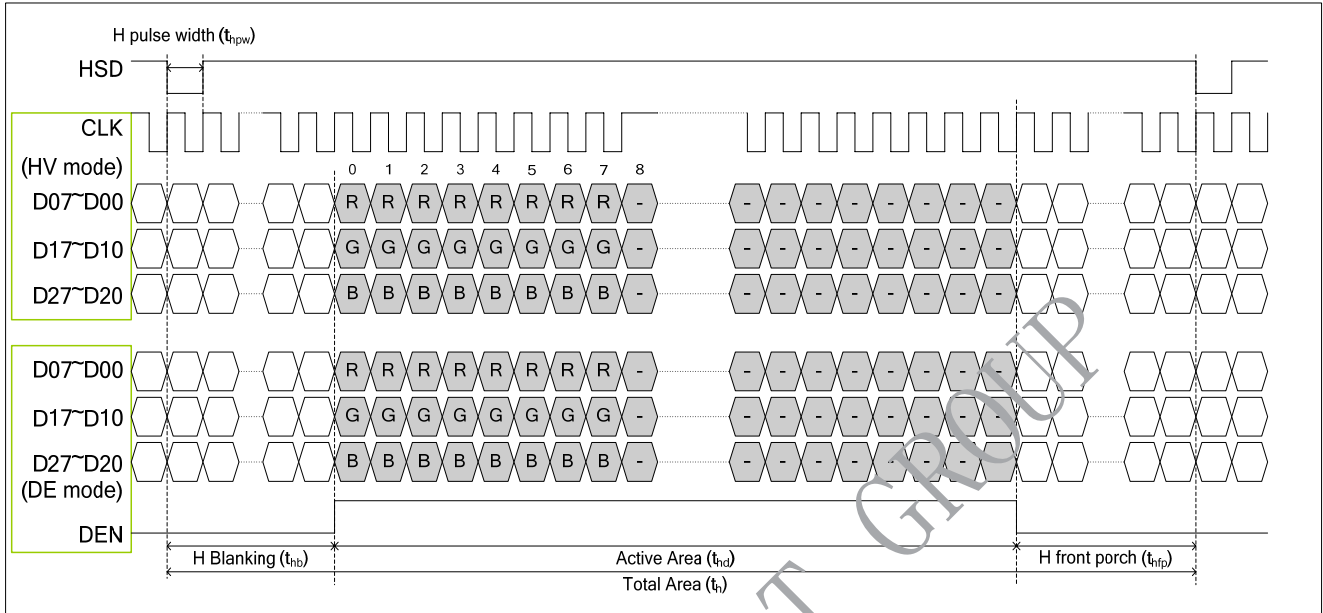

Figure 3.3 Horizontal input timing diagram

- Vertical Timing

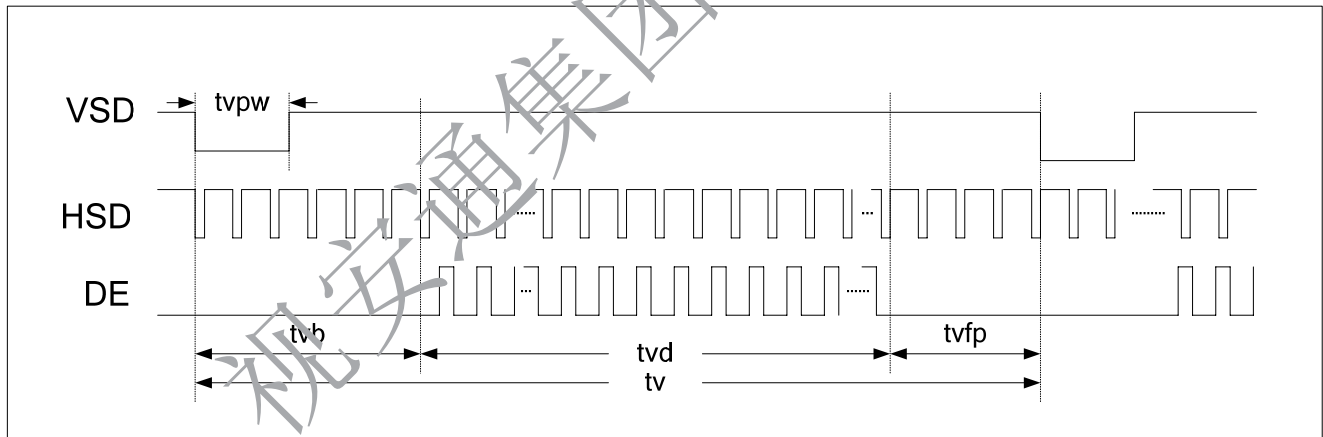

Figure 3.4: Vertical input timing diagram

3.3.3. Timing

● Horizontal Timing

Parameter	Symbol	Spec.			Unit
		Min.	Typ.	Max.	
Horizontal Display Area	thd	-	800	-	DCLK
DCLK frequency	fclk	-	33.3	50	MHz
One Horizontal Line	th	862	1056	1200	DCLK
HS pulse width (Min.)	thpw	1			DCLK
HS pulse width (Typical.)	thpw	-			DCLK
HS pulse width (Max.)	thpw	40			DCLK
HS Back Porch (Blanking)	thb	46	46	46	DCLK
HS Front Porch	thfp	16	210	354	DCLK
DE mode Blanking	th-thd	45	250	400	DCLK

● Vertical Timing

Parameter	Symbol	Spec.			Unit
		Min.	Typ.	Max.	
Vertical Display Area	tvd	480			TH
VS period time	tv	510	525	650	TH
VS pulse width	tvpw	1	-	20	TH
VS Back Porch (Blanking)	tvb	23	23	23	TH
VS Front Porch	tvfp	7	22	147	TH
DE mode Blanking	tv-tvd	4	45	170	TH

4. Optical Specifications

Ta=25 °C

Item	Symbol	Condition	Min	Typ	Max	Unit	Remark
View Angles	θT	$CR \geq 10$	40	50	--	Degree	Note1
	θB		50	60	--		
	θL		60	70	--		
	θR		60	70	--		
Contrast Ratio	CR	$\theta=0^\circ$	400	500	--		Note4
Response Time	T_{ON}	25°C	--	5	7	ms	Note3
	T_{OFF}		--	20	28		
Chromaticity	White	Backlight is on	x	0.237	0.287	0.337	Note2 Note5 Note6
			y	0.265	0.315	0.365	
Luminance	L		240	290	--	cd/m ²	Note6

Test Conditions:

1. $DV_{DD}=3.3V$, $I_L=140mA$ (Backlight current), the ambient temperature is 25°C.
2. The test systems refer to Note 2.

Note 1: Definition of viewing angle range

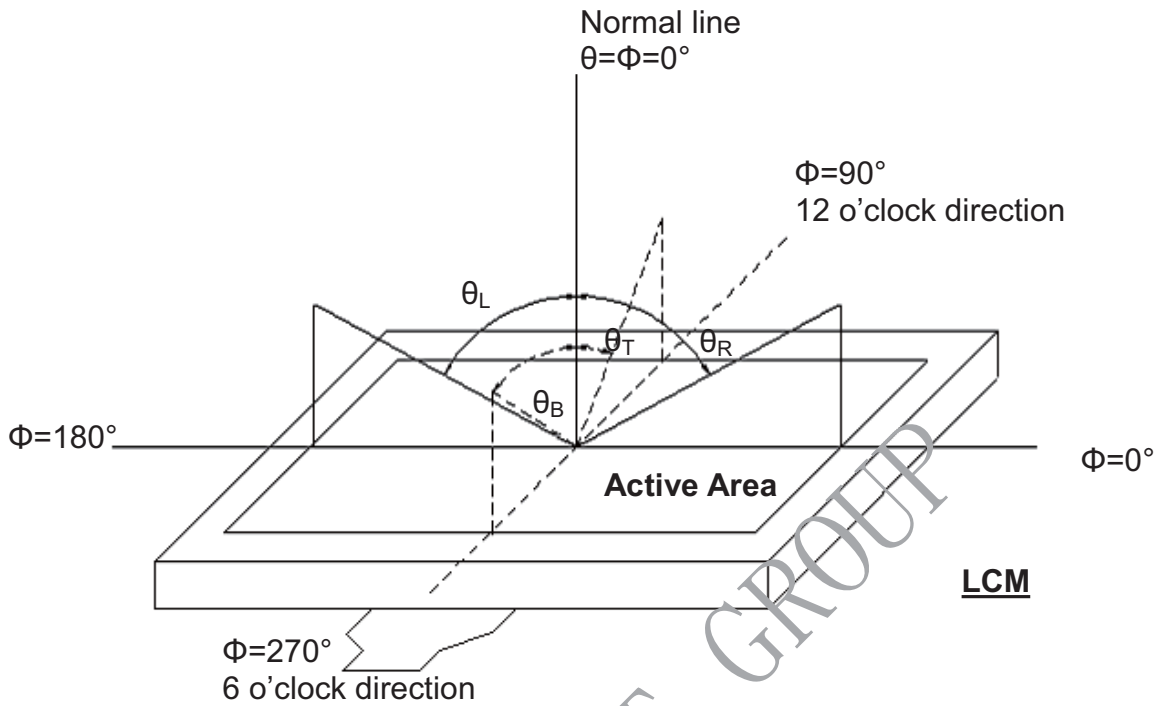

Fig. 4-1 Definition of viewing angle

Note 2: Definition of optical measurement system.

The optical characteristics should be measured in dark room. After 30 minutes operation, the optical properties are measured at the center point of the LCD screen. (Response time is measured by Photo detector TOPCON BM-7, other items are measured by BM-5A/Field of view: 1° /Height: 500mm.)

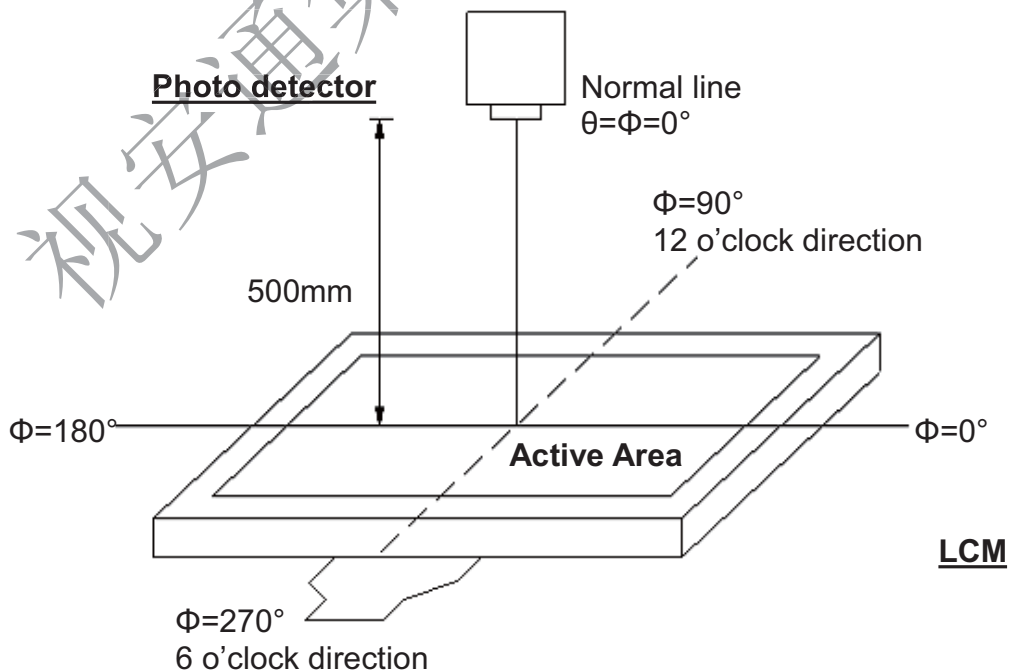

Fig. 4-2 Optical measurement system setup

Note 3: Definition of Response time

The response time is defined as the LCD optical switching time interval between "White" state and "Black" state. Rise time (T_{ON}) is the time between photo detector output intensity changed from 90% to 10%. And fall time (T_{OFF}) is the time between photo detector output intensity changed from 10% to 90%.

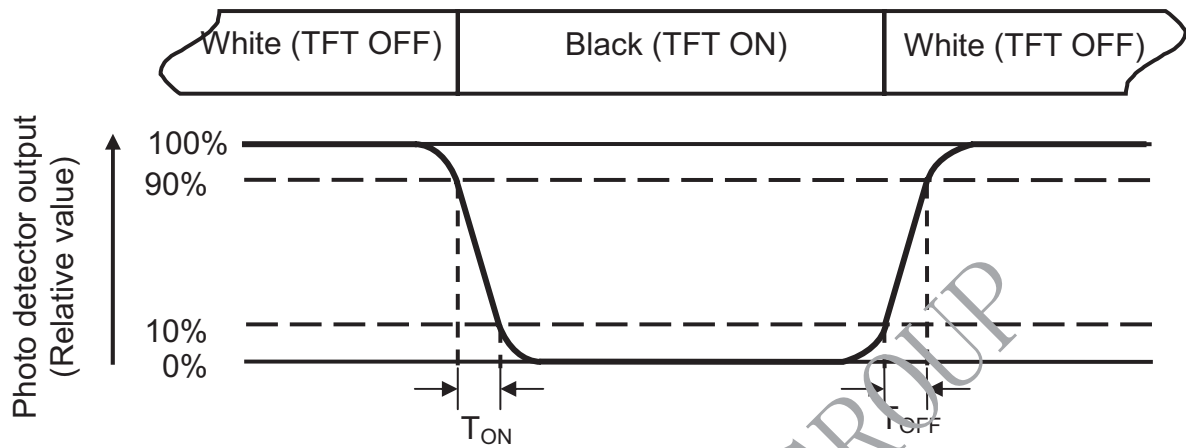

Fig. 4-3 Definition of response time

Note 4: Definition of contrast ratio

$$\text{Contrast ratio (CR)} = \frac{\text{Luminance measured when LCD on the "White" state}}{\text{Luminance measured when LCD on the "Black" state}}$$

Note 5: Definition of color chromaticity (CIE1931)

Color coordinates measured at center point of LCD.

Note 6: All input terminals LCD panel must be ground while measuring the center area of the panel.

Note 7: Definition of Luminance Uniformity

Active area is divided into 9 measuring areas (Refer to Fig. 4-4).Every measuring point is placed at the center of each measuring area.

$$\text{Luminance Uniformity (Yu)} = \frac{B_{min}}{B_{max}}$$

L-----Active area length W----- Active area width

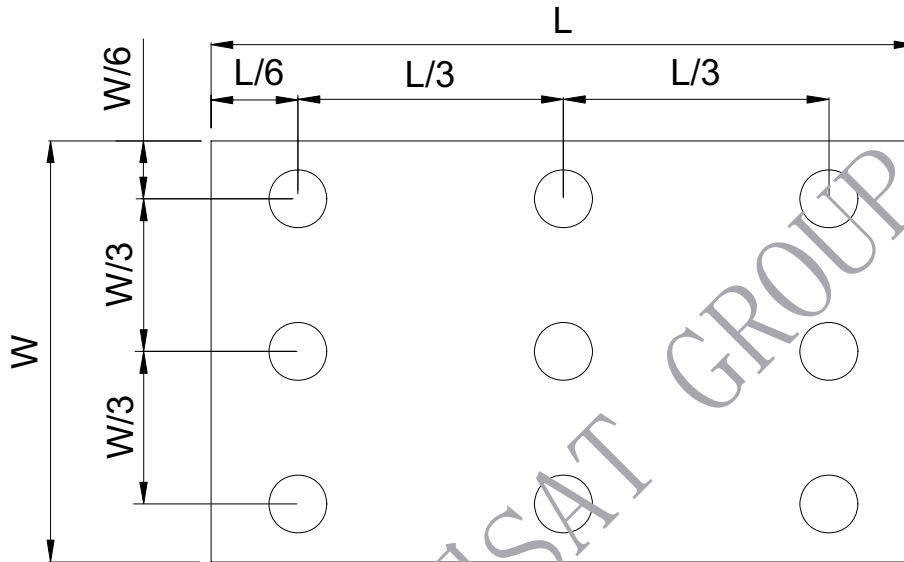

Fig. 4-4 Definition of measuring points

B_{max}: The measured maximum luminance of all measurement position.

B_{min}: The measured minimum luminance of all measurement position.

5. Reliability Test Items

(Note3)

Item	Test Conditions	Remark
High Temperature Storage	Ta = 80°C 240hrs	Note 1 · Note 4
Low Temperature Storage	Ta = -30°C 240hrs	Note 1 · Note 4
High Temperature Operation	Ts = 70°C 240hrs	Note 2 · Note 4
Low Temperature Operation	Ta = -20°C 240hrs	Note 1 · Note 4
Operate at High Temperature and Humidity	+60°C, 90%RH 240hrs	Note 4
Thermal Shock	-30°C/30 min ~ +80°C/30 min for a total 100 cycles, Start with cold temperature, and end with high temperature.	Note 4
Vibration Test	Frequency range:10~55Hz Stroke:1.5mm Sweep:10Hz~55Hz~10Hz 2 hours for each direction of X. Y. Z. (6 hours for total)	
Mechanical Shock	100G 6ms,±X, ±Y, ±Z 3 times for each direction	
Package Vibration Test	Random Vibration : 0.015G*G/Hz from 5-200HZ, -6dB/Octave from 200-500HZ 2 hours for each direction of X. Y. Z. (6 hours for total)	
Package Drop Test	Height:60 cm 1 corner, 3 edges, 6 surfaces	
Electro Static Discharge	± 2KV, Human Body Mode, 100pF/1500Ω	

Note 1: Ta is the ambient temperature of samples.

Note 2: Ts is the temperature of panel's surface.

Note 3: In the standard condition, there shall be no practical problem that may affect the display function. After the reliability test, the product only guarantees operation, but don't guarantee all of the cosmetic specification.

Note 4: Before cosmetic and function test, the product must have enough recovery time, at least 2 hours at room temperature.

6. General Precautions

6.1. Safety

Liquid crystal is poisonous. Do not put it in your mouth. If liquid crystal touches your skin or clothes, wash it off immediately by using soap and water.

6.2. Handling

1. The LCD panel is plate glass. Do not subject the panel to mechanical shock or to excessive force on its surface.
2. The polarizer attached to the display is easily damaged. Please handle it carefully to avoid scratch or other damages.
3. To avoid contamination on the display surface, do not touch the module surface with bare hands.
4. Keep a space so that the LCD panels do not touch other components.
5. Put cover board such as acrylic board on the surface of LCD panel to protect panel from damages.
6. Transparent electrodes may be disconnected if you use the LCD panel under environmental conditions where the condensation of dew occurs.
7. Do not leave module in direct sunlight to avoid malfunction of the ICs.

6.3. Static Electricity

1. Be sure to ground module before turning on power or operating module.
2. Do not apply voltage which exceeds the absolute maximum rating value.

6.4. Storage

1. Store the module in a dark room where must keep at $25\pm 10^{\circ}\text{C}$ and 65%RH or less.
2. Do not store the module in surroundings containing organic solvent or corrosive gas.
3. Store the module in an anti-electrostatic container or bag.

6.5. Cleaning

1. Do not wipe the polarizer with dry cloth. It might cause scratch.
2. Only use a soft sloth with IPA to wipe the polarizer, other chemicals might permanent damage to the polarizer.

7. Mechanical Drawing

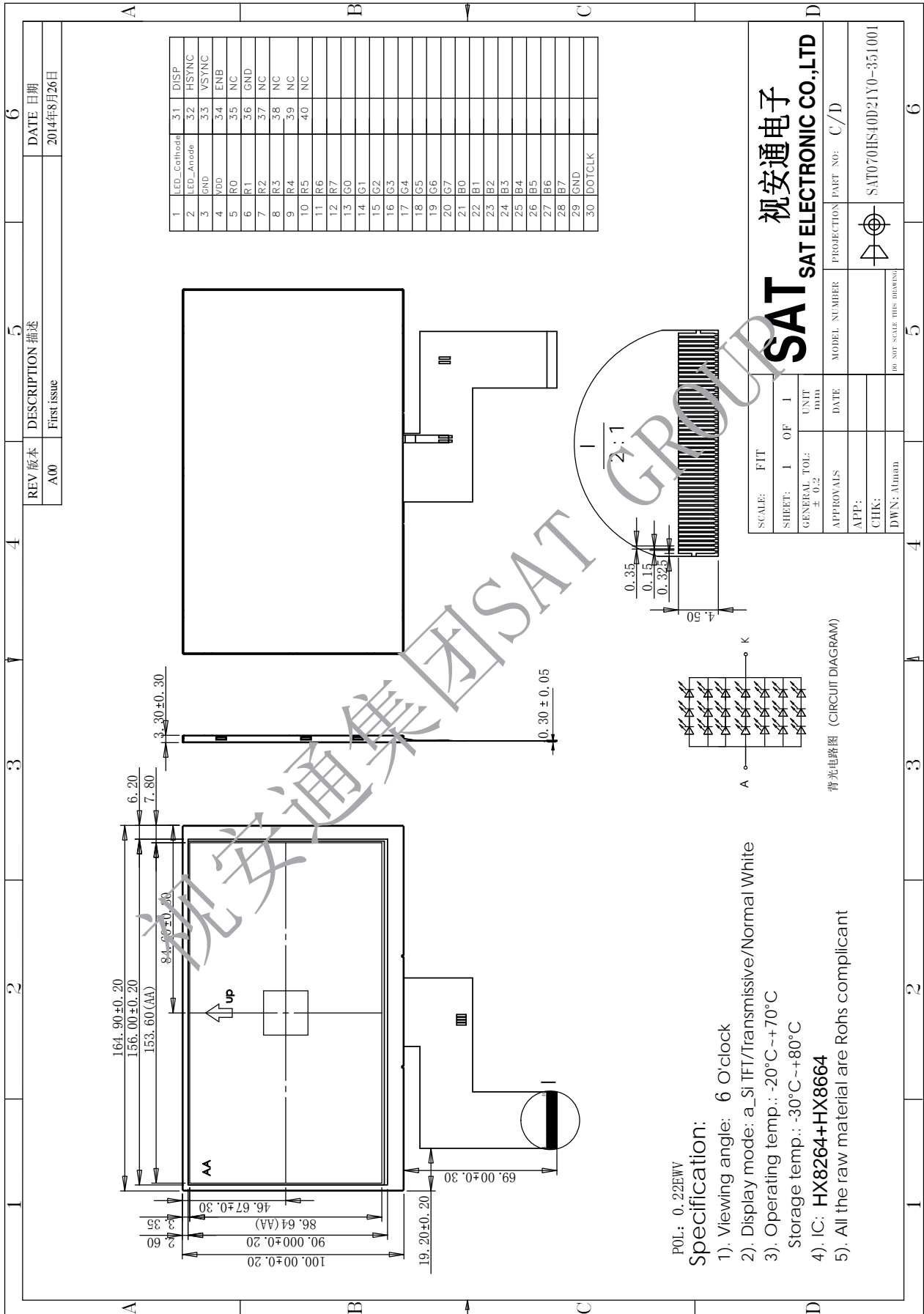

8. Package Drawing

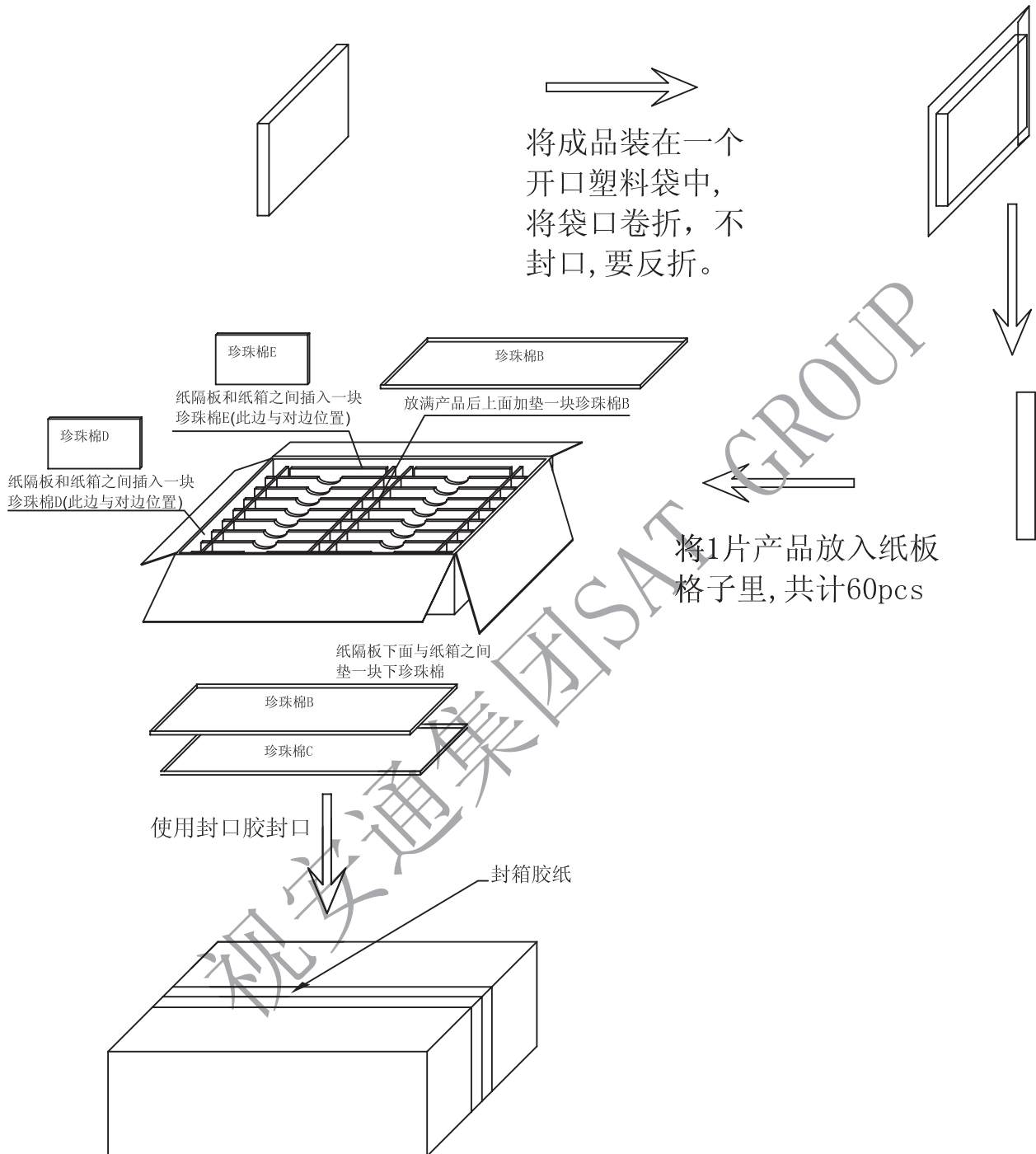

9 . Product ID Rule

Product Name



(1)



(2)



(3)



(4)



(5)



(6)



(7)



(8)



(9)



(10)



(11)

No	Definition	Specifications
(1)	TFT LCM Productor No.	SAT ---- SAT ELECTRONIC CO.LTD
(2)	Display monitor opposite angle line size	Unit :inch or mmm (size <10 inch: takes two integers ; size >=10 inch: takes three integers)
(3)	LCD Type	AU----AUO ; CP----CPT ; PV----PVI ; TM----TIANMA ; HS----HSD ; LG----LG ; Wi----Wintek ; CM----CMO ; HY----Hydis ; HI----Hitach; Sh----Sharp ; BO---BOE ...
(4)	Interface PIN Number	By two figures characters expression from 01 to 99
(5)	Interface Signal Type	A---- Alternated Video Signal; D---- Data Video Signal; H----HDV; I----IPS
(6)	LED backlight Lamp Number	By two figures characters expression from 01 to 99
(7)	LED Back Light colored warp	Rx----red ; Gx----green ; Bx---- blueness; Yx---- white; P----PVI; x---- warp distinction,1 minimal,9 maximal
(8)	Thickness	By two figures characters expression from 01 to 99

No	Definition	Specifications
(9)	Width	By three figures characters expression from 001 to 999
(10)	Product information	By one figure characters expression from 0 to 9
(11)	FPC Type	S---short M---Middle L---Long

视安通集团 SAT GROUP