

外形尺寸：435x343x150mm
 内部尺寸：390x270x134mm
 上盖/底壳内部深度：31/103mm

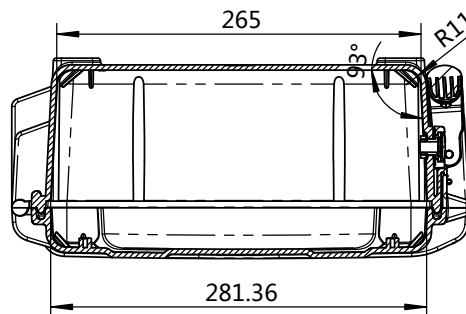
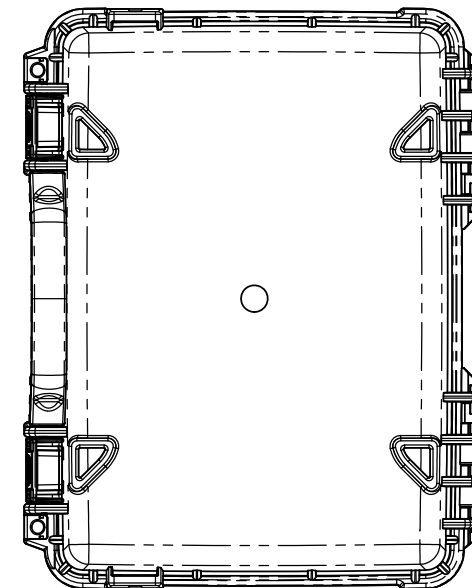
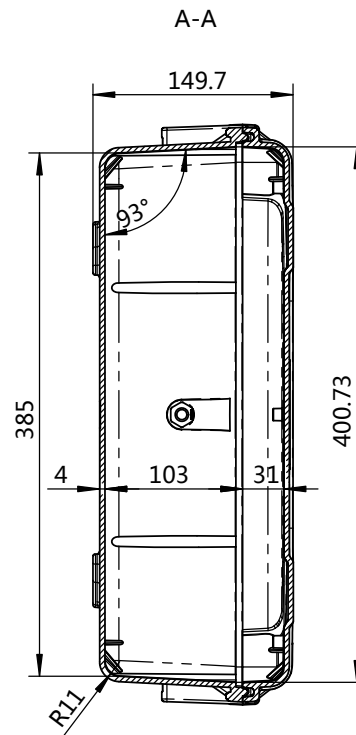
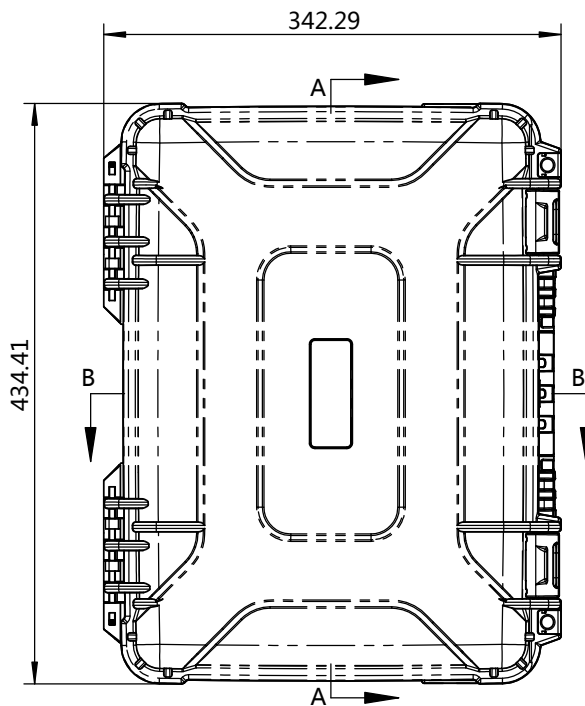
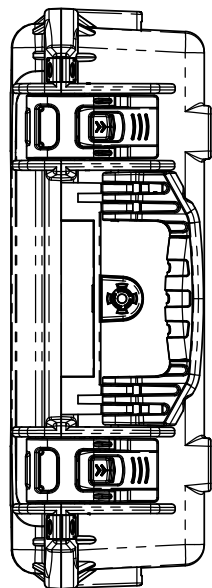

制图 Drawing	审核 Auditing	批准 Confirm	客户名称 Custom Name	本厂开发	材料 Material	
李松华			产品名称 Product Name	安全箱	图纸比例 Drawing Scale	1:4 A
2014.8.13			产品编号 Product Code	46-1456	视图 Project View	(mm)
共 1 页 第 1 页			宁波三和壳体公司 NINGBO SANHE ENCLOSURE CORPORATION		中国·宁波慈溪 TEL:+86(574)63226910 FAX:+86(574)63226900	