



# SGM8249-1/SGM8249-2

## 8MHz, High Voltage, High Precision, Low Noise, Rail-to-Rail Output Operational Amplifiers

### GENERAL DESCRIPTION

The single SGM8249-1 and dual SGM8249-2 are high voltage, low noise and high precision operational amplifiers which can operate from 4.5V to 36V single supply or from  $\pm 2.25V$  to  $\pm 18V$  dual supplies. These devices provide rail-to-rail output operation.

The SGM8249-1/2 offer a low offset voltage less than  $10\mu V$  and a low bias current. The combination of characteristics makes the SGM8249-1/2 good choices for temperature measurements, pressure and position sensors, strain gauge amplifiers and medical instrumentation, or any other 4.5V to 36V applications requiring precision and long-term stability.

The SGM8249-1 is available in Green SOT-23-5 and SOIC-8 packages. The SGM8249-2 is available in a Green SOIC-8 package. The SGM8249-1/2 are rated over the  $-40^{\circ}C$  to  $+125^{\circ}C$  temperature range.

### FEATURES

- **Low Offset Voltage:  $10\mu V$  (MAX)**
- **Open-Loop Voltage Gain: 150dB (TYP)**
- **PSRR: 150dB (TYP)**
- **CMRR: 140dB (TYP)**
- **Input Voltage Noise Density:  $10nV/\sqrt{Hz}$  at 1kHz**
- **Gain-Bandwidth Product: 8MHz**
- **Overload Recovery Time:  $0.7\mu s$**
- **Rail-to-Rail Output Swing**
- **Support Single or Dual Power Supplies:  
4.5V to 36V or  $\pm 2.25V$  to  $\pm 18V$**
- **Low Supply Current: 0.85mA/Amplifier (TYP)**
- **$-40^{\circ}C$  to  $+125^{\circ}C$  Operating Temperature Range**
- **Small Packaging:  
SGM8249-1 Available in Green SOT-23-5 and  
SOIC-8 Packages  
SGM8249-2 Available in a Green SOIC-8 Package**

### APPLICATIONS

Pressure Sensors  
Temperature Measurements  
Precision Current Sensing  
Electronic Scales  
Strain Gauge Amplifiers  
Handheld Test Equipment  
Thermocouple Amplifiers  
Medical Instrumentation

**PACKAGE/ORDERING INFORMATION**

MODEL	PACKAGE DESCRIPTION	SPECIFIED TEMPERATURE RANGE	ORDERING NUMBER	PACKAGE MARKING	PACKING OPTION
SGM8249-1	SOT-23-5	-40°C to +125°C	SGM8249-1XN5G/TR	GM7XX	Tape and Reel, 3000
	SOIC-8	-40°C to +125°C	SGM8249-1XS8G/TR	SGM 82491XS8 XXXXX	Tape and Reel, 4000
SGM8249-2	SOIC-8	-40°C to +125°C	SGM8249-2XS8G/TR	SGM 82492XS8 XXXXX	Tape and Reel, 4000

**MARKING INFORMATION**

NOTE: XX = Date Code. XXXXX = Date Code and Vendor Code.

**SOT-23-5**

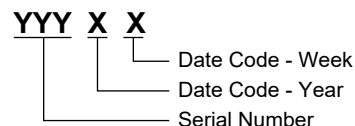

**SOIC-8**

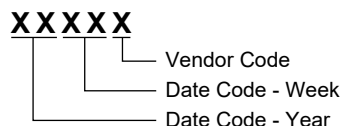

Green (RoHS & HSF): SG Micro Corp defines "Green" to mean Pb-Free (RoHS compatible) and free of halogen substances. If you have additional comments or questions, please contact your SGMICRO representative directly.

**ABSOLUTE MAXIMUM RATINGS**

- Supply Voltage..... 40V
- Input Voltage Range ..... -Vs to (+Vs) + 0.1V
- Differential Input Voltage Range ..... -1V to 1V
- Junction Temperature ..... +150°C
- Storage Temperature Range..... -65°C to +150°C
- Lead Temperature (Soldering, 10s) ..... +260°C
- ESD Susceptibility
- HBM..... 6000V
- MM..... 300V
- CDM ..... 1000V

**RECOMMENDED OPERATING CONDITIONS**

- Operating Voltage Range..... 4.5V to 36V
- Operating Temperature Range ..... -40°C to +125°C

**OVERSTRESS CAUTION**

Stresses beyond those listed in Absolute Maximum Ratings may cause permanent damage to the device. Exposure to absolute maximum rating conditions for extended periods

may affect reliability. Functional operation of the device at any conditions beyond those indicated in the Recommended Operating Conditions section is not implied.

**ESD SENSITIVITY CAUTION**

This integrated circuit can be damaged if ESD protections are not considered carefully. SGMICRO recommends that all integrated circuits be handled with appropriate precautions. Failure to observe proper handling and installation procedures can cause damage. ESD damage can range from subtle performance degradation to complete device failure. Precision integrated circuits may be more susceptible to damage because even small parametric changes could cause the device not to meet the published specifications.

**DISCLAIMER**

SG Micro Corp reserves the right to make any change in circuit design, or specifications without prior notice.

**PIN CONFIGURATIONS**

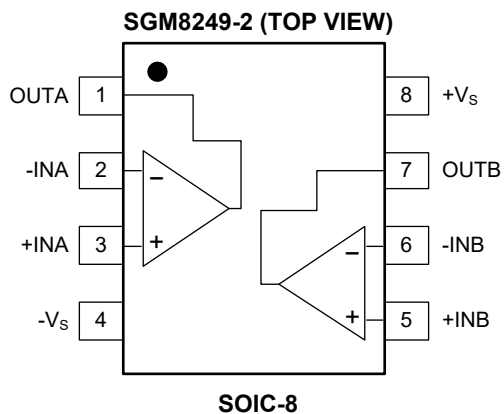
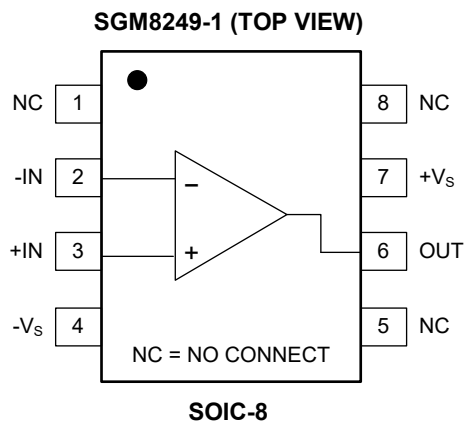
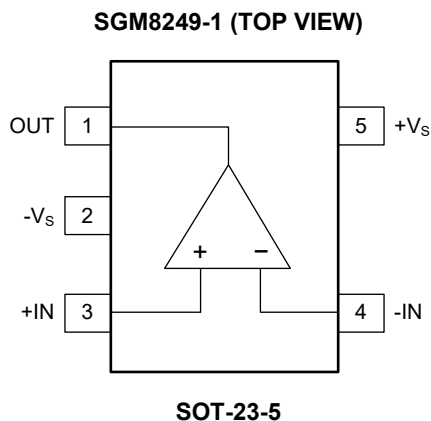

**ELECTRICAL CHARACTERISTICS**

(At  $T_A = +25^\circ\text{C}$ ,  $V_S = \pm 2.25\text{V}$  to  $\pm 18\text{V}$ ,  $V_{CM} = 0\text{V}$  and  $R_L = 5\text{k}\Omega$  connected to  $0\text{V}$ , Full =  $-40^\circ\text{C}$  to  $+125^\circ\text{C}$ , unless otherwise noted.)

PARAMETER	SYMBOL	CONDITIONS	TEMP	MIN	TYP	MAX	UNITS
<b>Input Characteristics</b>							
Input Offset Voltage	$V_{OS}$		+25°C		2	10	$\mu\text{V}$
			Full			15	
Input Offset Voltage Drift	$\Delta V_{OS}/\Delta T$		Full		12		$\text{nV}/^\circ\text{C}$
Input Bias Current	$I_B$		+25°C		$\pm 100$	$\pm 400$	$\text{pA}$
Input Offset Current	$I_{OS}$		+25°C		$\pm 200$	$\pm 600$	$\text{pA}$
Input Common Mode Voltage Range	$V_{CM}$		Full	$(-V_S)$		$(+V_S) - 1.5$	$\text{V}$
Common Mode Rejection Ratio	CMRR	$V_{CM} = (-V_S)$ to $(+V_S) - 1.5\text{V}$	+25°C	118	140		$\text{dB}$
			Full	115			
Open-Loop Voltage Gain	$A_{OL}$	$V_S = \pm 2.25\text{V}$ , $V_{OUT} = \pm 2.0\text{V}$	+25°C	120	150		$\text{dB}$
			Full	117			
		$V_S = \pm 18\text{V}$ , $V_{OUT} = \pm 17.5\text{V}$	+25°C	128	155		
			Full	125			
<b>Output Characteristics</b>							
Output Voltage Swing from Rail		$V_S = \pm 2.25\text{V}$	+25°C		22	32	$\text{mV}$
			Full			35	
		$V_S = \pm 18\text{V}$	+25°C		170	240	
			Full			285	
Output Short-Circuit Current	$I_{SC}$	$V_S = \pm 2.25\text{V}$	+25°C	$\pm 25$	$\pm 35$		$\text{mA}$
			Full	$\pm 14$			
		$V_S = \pm 18\text{V}$	+25°C	$\pm 60$	$\pm 70$		
			Full	$\pm 44$			
<b>Power Supply</b>							
Operating Voltage Range	$V_S$		Full	4.5		36	$\text{V}$
Quiescent Current/Amplifier	$I_Q$	$I_{OUT} = 0$	+25°C		0.85	1.2	$\text{mA}$
			Full			1.3	
Power Supply Rejection Ratio	PSRR	$V_S = 4.5\text{V}$ to $36\text{V}$	+25°C	128	150		$\text{dB}$
			Full	125			
<b>Dynamic Performance</b>							
Gain-Bandwidth Product	GBP	$V_{OUT} = 100\text{mV}_{P-P}$ , $C_L = 10\text{pF}$	+25°C		8		$\text{MHz}$
Slew Rate	SR		+25°C		6		$\text{V}/\mu\text{s}$
Settling Time to 0.1%	$t_s$	$V_{IN} = 1\text{V}$ step, $A_V = +1$	+25°C		0.8		$\mu\text{s}$
Overload Recovery Time		$V_{IN} \times A_V > V_S$	+25°C		0.7		$\mu\text{s}$
Total Harmonic Distortion + Noise	THD+N	$V_{IN} = 2\text{V}_{P-P}$ , $A_V = +1$ , $f = 1\text{kHz}$	+25°C		0.0002		$\%$
<b>Noise</b>							
Input Voltage Noise		$f = 0.1\text{Hz}$ to $10\text{Hz}$	+25°C		0.2		$\mu\text{V}_{P-P}$
Input Voltage Noise Density	$e_n$	$f = 0.1\text{kHz}$	+25°C		10		$\text{nV}/\sqrt{\text{Hz}}$
		$f = 1\text{kHz}$	+25°C		10		
		$f = 10\text{kHz}$	+25°C		11		
			+25°C				

**TYPICAL PERFORMANCE CHARACTERISTICS**

At  $T_A = +25^\circ\text{C}$ ,  $V_S = \pm 15\text{V}$ ,  $C_L = 10\text{pF}$  and  $R_L = 5\text{k}\Omega$ , unless otherwise noted.

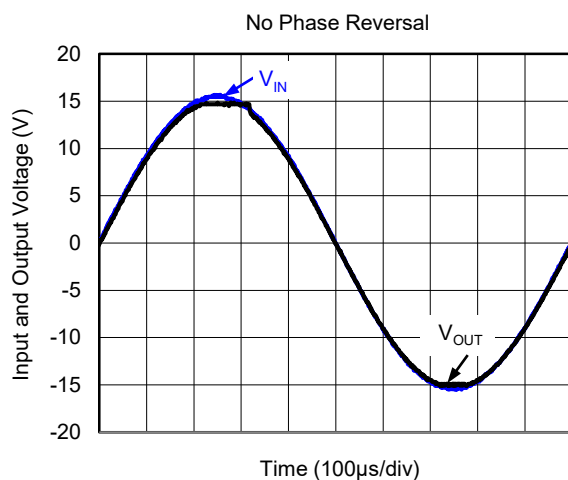
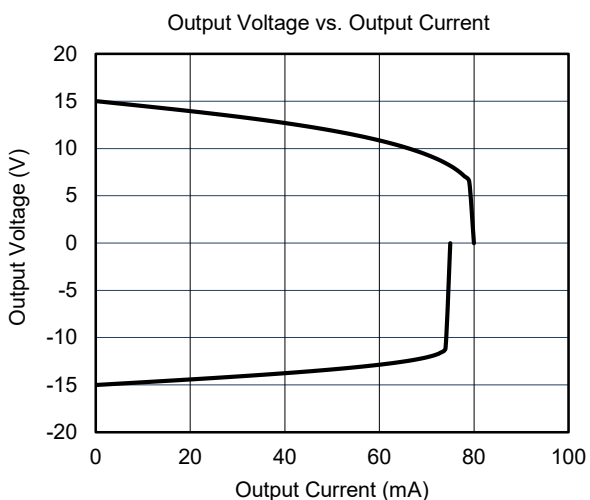
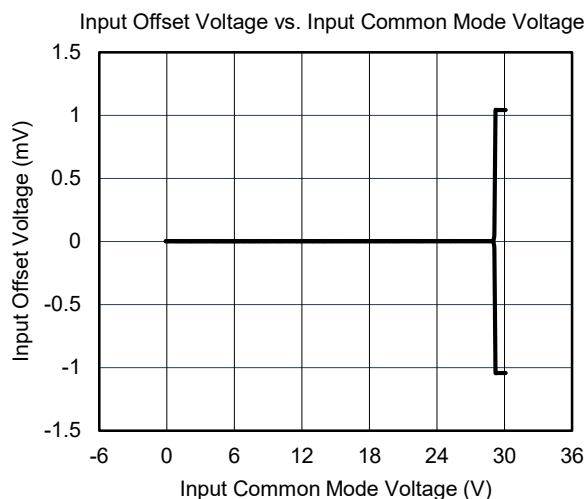
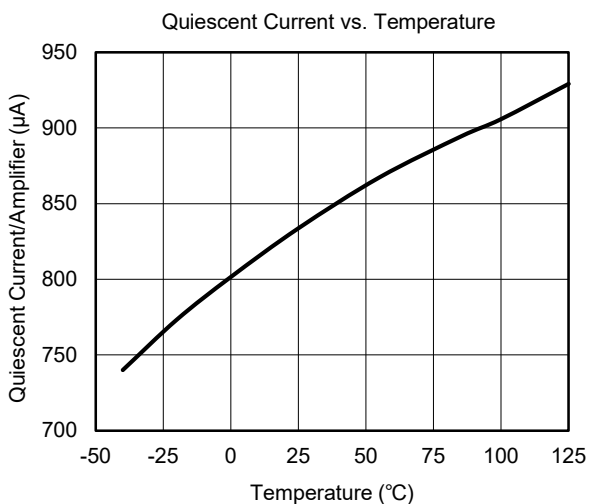
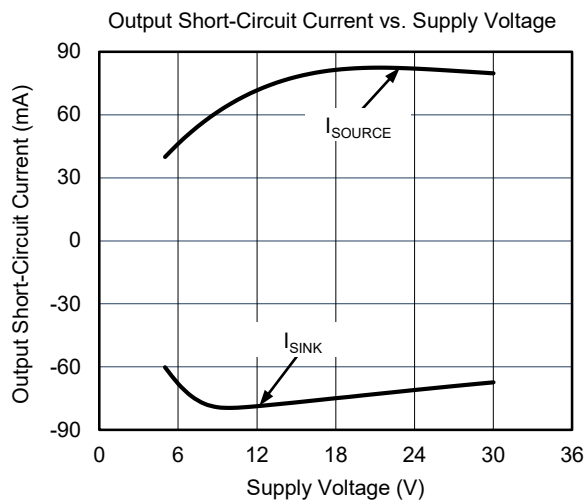
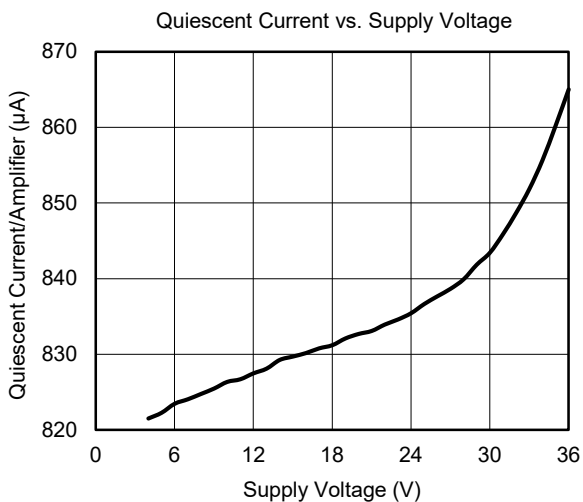

**TYPICAL PERFORMANCE CHARACTERISTICS (continued)**

At  $T_A = +25^\circ\text{C}$ ,  $V_S = \pm 15\text{V}$ ,  $C_L = 10\text{pF}$  and  $R_L = 5\text{k}\Omega$ , unless otherwise noted.

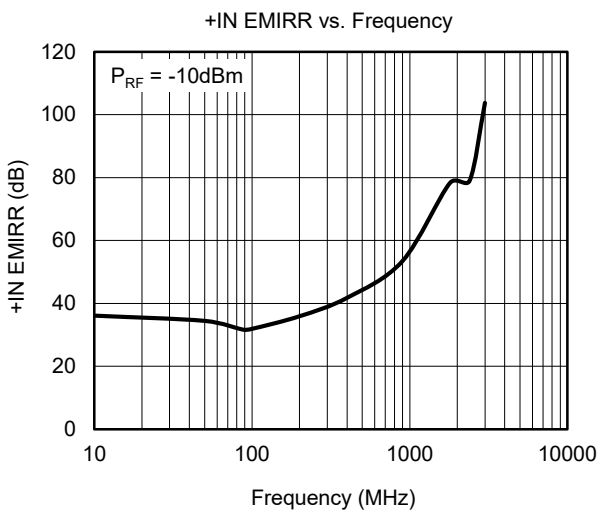
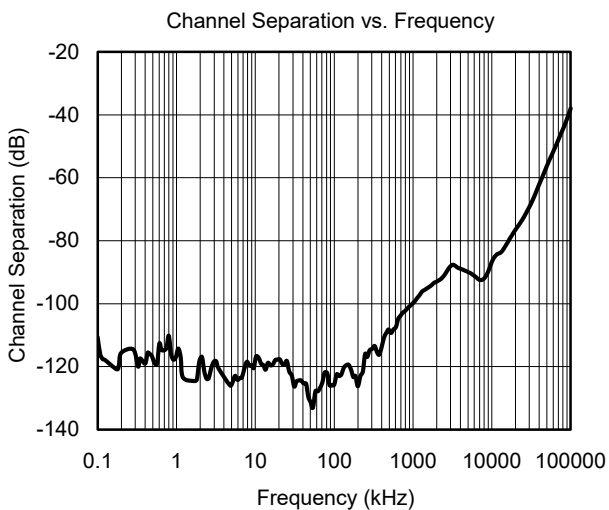
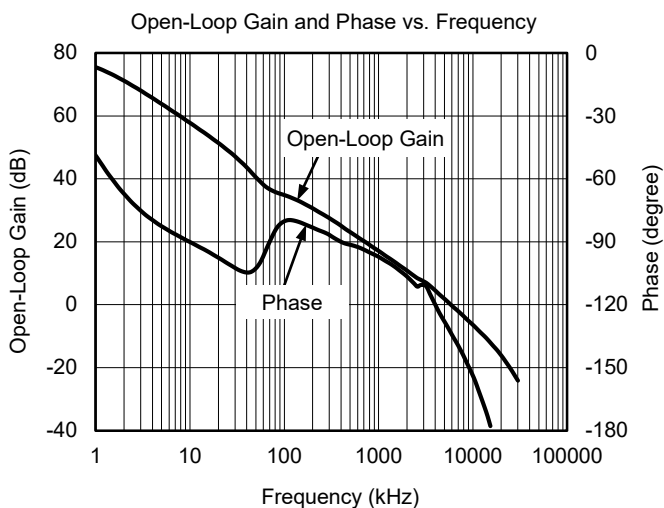
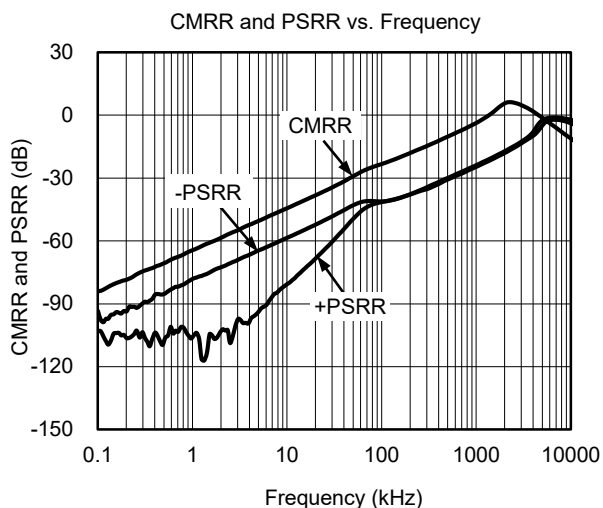
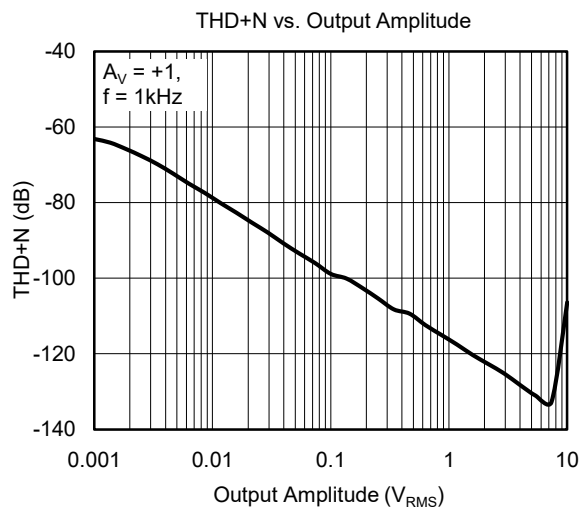
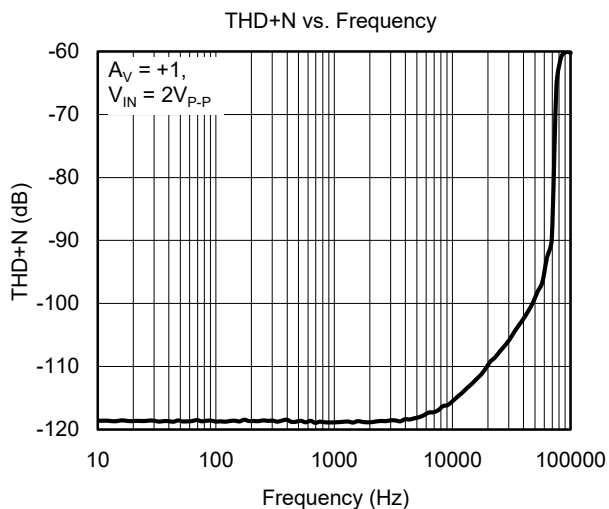

**TYPICAL PERFORMANCE CHARACTERISTICS (continued)**

At  $T_A = +25^\circ\text{C}$ ,  $V_S = \pm 15\text{V}$ ,  $C_L = 10\text{pF}$  and  $R_L = 5\text{k}\Omega$ , unless otherwise noted.

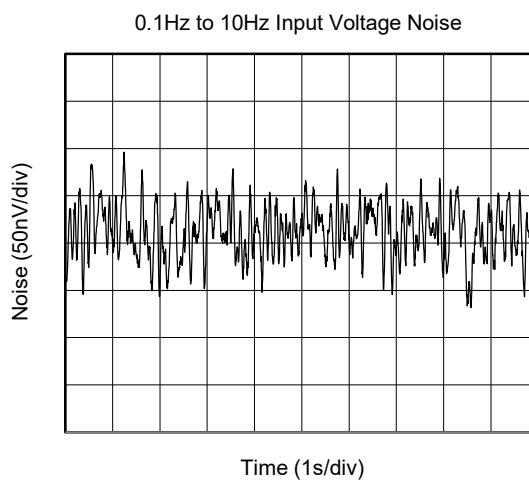
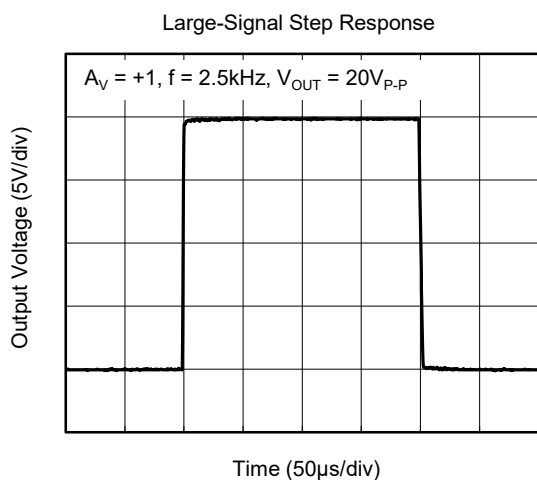
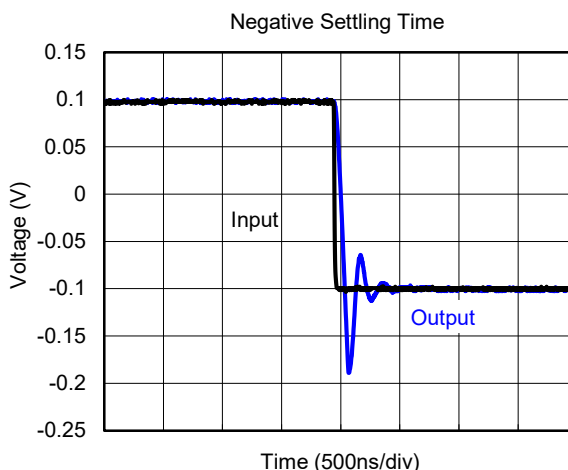
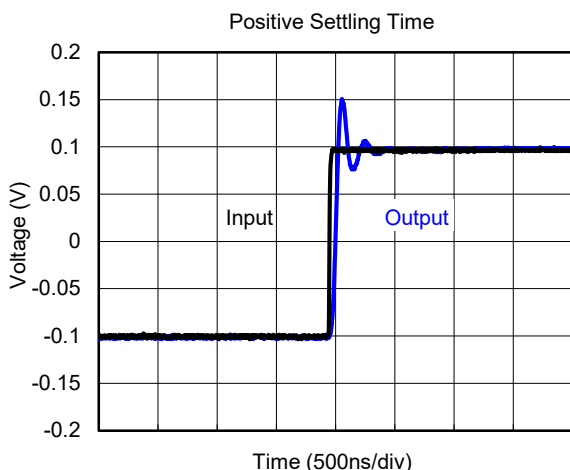
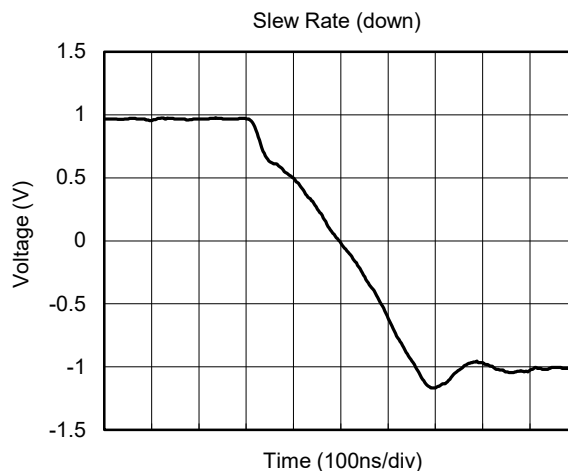
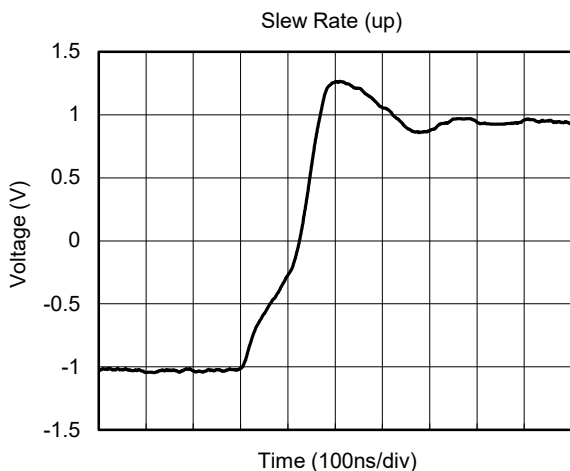

**TYPICAL PERFORMANCE CHARACTERISTICS (continued)**

At  $T_A = +25^\circ\text{C}$ ,  $V_S = \pm 15\text{V}$ ,  $C_L = 10\text{pF}$  and  $R_L = 5\text{k}\Omega$ , unless otherwise noted.

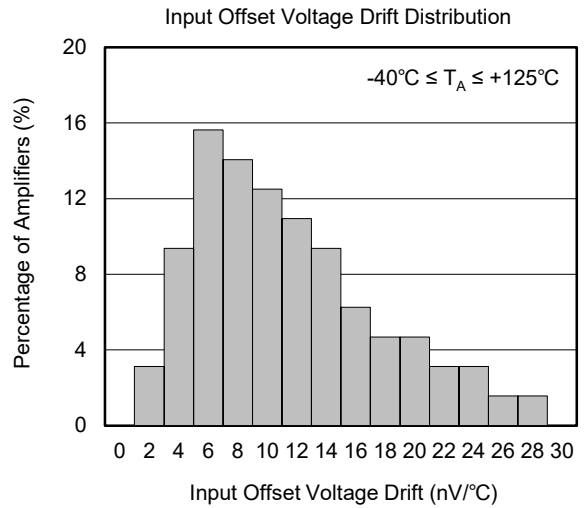
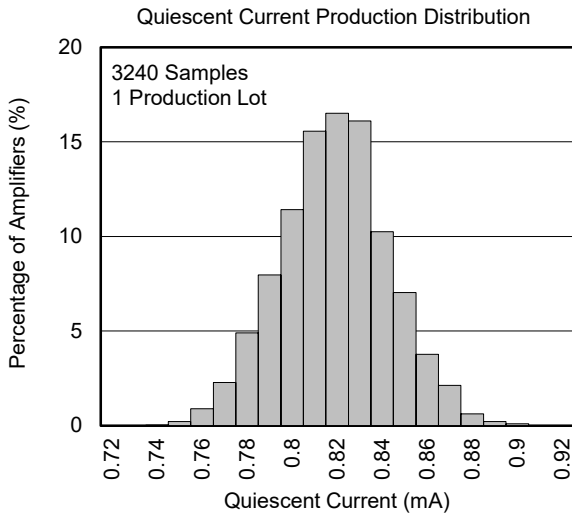
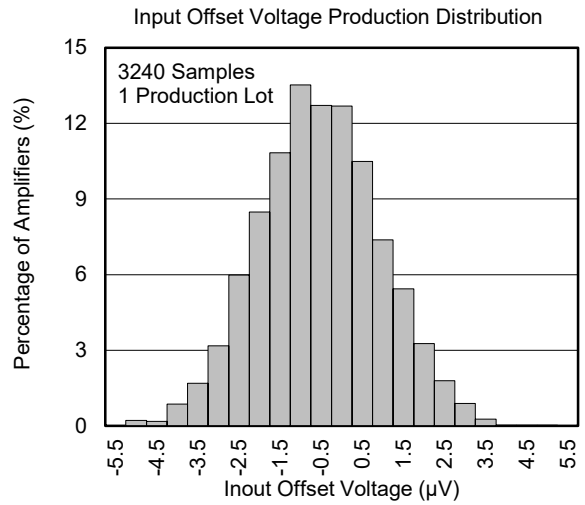
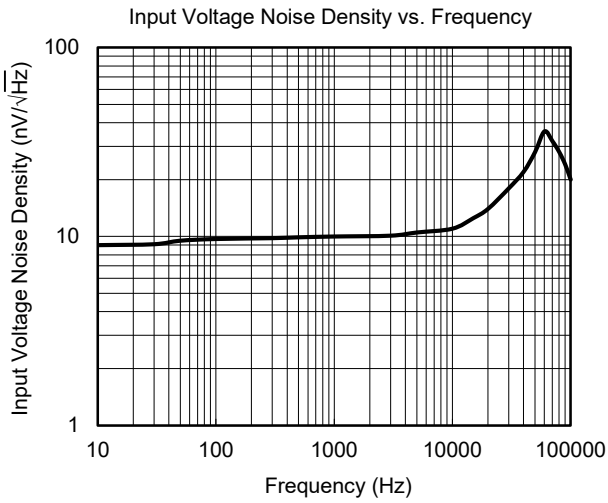



## **REVISION HISTORY**

NOTE: Page numbers for previous revisions may differ from page numbers in the current version.

<b>OCTOBER 2019 – REV.A to REV.A.1</b>	<b>Page</b>
Updated Marking Information section.....	2

---

<b>Changes from Original (DECEMBER 2017) to REV.A</b>	<b>Page</b>
Changed from product preview to production data.....	All

---

PACKAGE OUTLINE DIMENSIONS

SOT-23-5

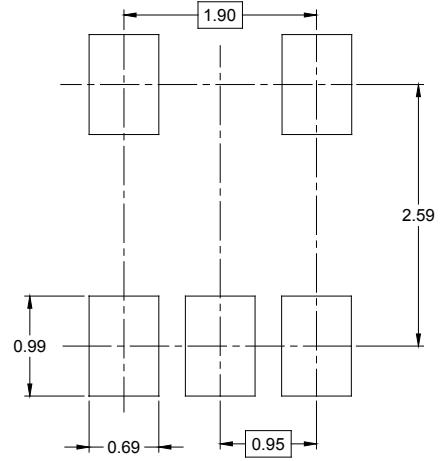

RECOMMENDED LAND PATTERN (Unit: mm)



Symbol	Dimensions In Millimeters		Dimensions In Inches	
	MIN	MAX	MIN	MAX
A	1.050	1.250	0.041	0.049
A1	0.000	0.100	0.000	0.004
A2	1.050	1.150	0.041	0.045
b	0.300	0.500	0.012	0.020
c	0.100	0.200	0.004	0.008
D	2.820	3.020	0.111	0.119
E	1.500	1.700	0.059	0.067
E1	2.650	2.950	0.104	0.116
e	0.950 BSC		0.037 BSC	
e1	1.900 BSC		0.075 BSC	
L	0.300	0.600	0.012	0.024
$\theta$	0°	8°	0°	8°

PACKAGE OUTLINE DIMENSIONS

SOIC-8

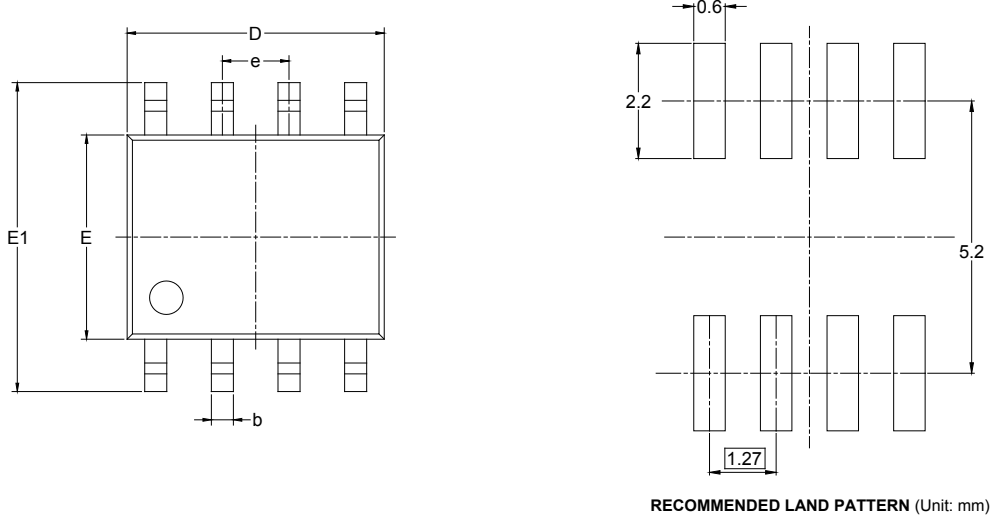

Symbol	Dimensions In Millimeters		Dimensions In Inches	
	MIN	MAX	MIN	MAX
A	1.350	1.750	0.053	0.069
A1	0.100	0.250	0.004	0.010
A2	1.350	1.550	0.053	0.061
b	0.330	0.510	0.013	0.020
c	0.170	0.250	0.006	0.010
D	4.700	5.100	0.185	0.200
E	3.800	4.000	0.150	0.157
E1	5.800	6.200	0.228	0.244
e	1.27 BSC		0.050 BSC	
L	0.400	1.270	0.016	0.050
$\theta$	0°	8°	0°	8°

## TAPE AND REEL INFORMATION

### REEL DIMENSIONS



### TAPE DIMENSIONS



NOTE: The picture is only for reference. Please make the object as the standard.

### KEY PARAMETER LIST OF TAPE AND REEL

Package Type	Reel Diameter	Reel Width W1 (mm)	A0 (mm)	B0 (mm)	K0 (mm)	P0 (mm)	P1 (mm)	P2 (mm)	W (mm)	Pin1 Quadrant
SOT-23-5	7"	9.5	3.20	3.20	1.40	4.0	4.0	2.0	8.0	Q3
SOIC-8	13"	12.4	6.40	5.40	2.10	4.0	8.0	2.0	12.0	Q1

D00001

# PACKAGE INFORMATION

## CARTON BOX DIMENSIONS



NOTE: The picture is only for reference. Please make the object as the standard.

## KEY PARAMETER LIST OF CARTON BOX

Reel Type	Length (mm)	Width (mm)	Height (mm)	Pizza/Carton
7" (Option)	368	227	224	8
7"	442	410	224	18
13"	386	280	370	5

DD0002