	<h2 style="margin: 0;">APPROVAL SHEET</h2> <p style="margin: 0;">No. <u>080T0</u></p>
安勤科技股份有限公司	0000005454

<input checked="" type="radio"/> 合格 Approval	<input type="radio"/> 不合格 Rejected	<input type="radio"/> 試用 Limited Qty. _____ PCS	送樣次數 <input type="radio"/> <input type="radio"/> <input type="radio"/> <input type="radio"/> <input type="radio"/> <input type="radio"/> <input type="radio"/>	1 2 3 4 5 6 7
---	---------------------------------------	--	---	---------------

品名	LVDS Cable 30P/1.00-40P/1.25 50cm for EPM-1534 & AUO M201EW02 V8(RoHS)
規格	
料號	E1704700505R
使用機種	適用於:EPM-1534

製造商/代理商	快異點
廠商型號	E1704700505R

備註  
Remark

檢驗重點如螢光筆標示, " 顏色如承認書的Mapping所示 ".



檢驗者	Signature	OK/NG	Date
	郭沁群	OK	2008/07/29
審核	康有民	OK	2008/07/29
AE	邱瓊儀	OK	2008/08/01
Web Update			
資料中心	任雅欣	OK	2008/08/01
審核	黃意婷	OK	2008/08/01
備註	1、以上所記, 已經檢驗過, 並給予承認。 2、本單不能代替採購單及其它用途。 3、如涉及專利及法律之問題, 應由送樣廠商負全責。		

附件	型式		發行單位					
	實物 /書面	電子檔	工程	採購	廠商	品保	研發	資料中心
廠商承認書	<input type="checkbox"/>	<input checked="" type="checkbox"/>	<input type="checkbox"/>	<input type="checkbox"/>	<input checked="" type="checkbox"/>	<input checked="" type="checkbox"/>	<input type="checkbox"/>	<input checked="" type="checkbox"/>
樣品	<input type="checkbox"/>	<input checked="" type="checkbox"/>	<input type="checkbox"/>	<input type="checkbox"/>	<input type="checkbox"/>	<input type="checkbox"/>	<input type="checkbox"/>	<input checked="" type="checkbox"/>
圖檔	<input type="checkbox"/>	<input type="checkbox"/>	<input type="checkbox"/>	<input type="checkbox"/>	<input type="checkbox"/>	<input type="checkbox"/>	<input type="checkbox"/>	<input type="checkbox"/>
BIOS	<input type="checkbox"/>	<input type="checkbox"/>	<input type="checkbox"/>	<input type="checkbox"/>	<input type="checkbox"/>	<input type="checkbox"/>	<input type="checkbox"/>	<input type="checkbox"/>
Gerber	<input type="checkbox"/>	<input type="checkbox"/>	<input type="checkbox"/>	<input type="checkbox"/>	<input type="checkbox"/>	<input type="checkbox"/>	<input type="checkbox"/>	<input type="checkbox"/>
PCB 底片	<input type="checkbox"/>	<input type="checkbox"/>	<input type="checkbox"/>	<input type="checkbox"/>	<input type="checkbox"/>	<input type="checkbox"/>	<input type="checkbox"/>	<input type="checkbox"/>

QD4-015 Rev.A6

料號	E1704700505R		測試日期	2008/07/29
品名規格	LVDS Cable 30P/1.00-40P/1.25 50cm for EPM-1534 & AUO M201EW02 V8(RoHS)			
使用機種	適用於:EPM-1534		測試樣品數	3 PCS
測試項目	勾選	項目	測試條件	結果
	<input checked="" type="checkbox"/>	外觀	目檢	<input checked="" type="radio"/> Pass <input type="radio"/> NG
	<input type="checkbox"/>	材質		<input type="radio"/> Pass <input type="radio"/> NG
	<input checked="" type="checkbox"/>	電氣特性	電表量測	<input checked="" type="radio"/> Pass <input type="radio"/> NG
	<input type="checkbox"/>	機械強度		<input type="radio"/> Pass <input type="radio"/> NG
	<input type="checkbox"/>	實裝動作		<input type="radio"/> Pass <input type="radio"/> NG
	<input type="checkbox"/>	破壞實驗		<input type="radio"/> Pass <input type="radio"/> NG
	<input type="checkbox"/>	顏色		<input type="radio"/> Pass <input type="radio"/> NG
	<input type="checkbox"/>	尺寸		<input type="radio"/> Pass <input type="radio"/> NG
	<input type="checkbox"/>	沾錫性		<input type="radio"/> Pass <input type="radio"/> NG
	<input type="checkbox"/>	壽命實驗		<input type="radio"/> Pass <input type="radio"/> NG
	<input type="checkbox"/>	安規		<input type="radio"/> Pass <input type="radio"/> NG
	<input type="checkbox"/>			<input type="radio"/> Pass <input type="radio"/> NG
<input type="checkbox"/>			<input type="radio"/> Pass <input type="radio"/> NG	
使用儀器	三用電表 			
備註				
測試結果	<input checked="" type="radio"/> 符合測試條件及規格 <input type="radio"/> 不符合，原因略述			
單位主管	康有民		檢驗者	郭沁群

QD4-017

第0020關

支號：0010 (流程角色：直屬主管) 表單關係人

收件人員	簽核人員	收件時間	2008/07/29 14:19:00	簽核時間	2008/07/29 14:48:52	簽核結果	同意
004 康有民	004 康有民						歷史簽核紀錄

第0030關

支號：0010 (流程角色：員工) 125 邱瓊儀

收件人員	簽核人員	收件時間	2008/07/29 14:48:52	簽核時間	2008/08/01 11:33:09	簽核結果	同意
------	------	------	---------------------	------	---------------------	------	----

125 邱瓊儀	125 邱瓊儀					歷史簽核紀錄
------------	------------	--	--	--	--	--------

## 第0050關

支號：0010 (流程角色：員工) 032 任雅欣

收件人員	簽核人員	收件時間	2008/08/01 11:33:09	簽核時間	2008/08/01 13:26:47	簽核結果	同意
032 任雅欣	032 任雅欣					歷史簽核紀錄	

## 第0060關

支號：0010 (流程角色：直屬主管) 關號= 0050 支號= 0010

收件人員	簽核人員	收件時間	2008/08/01 13:26:47	簽核時間	2008/08/01 13:34:23	簽核結果	同意
027 黃意婷	027 黃意婷					歷史簽核紀錄	

## 第0070關

支號：0010 (流程角色：員工) 032 任雅欣

收件人員	簽核人員	收件時間	2008/08/01 13:34:23	簽核時間	2008/08/01 13:39:27	簽核結果	同意
032 任雅欣	032 任雅欣					歷史簽核紀錄	



# 承 認 書

客戶：\_\_\_\_\_安勤科技股份有限公司\_\_\_\_\_

機種：\_\_\_\_\_

料號：\_\_\_\_\_E1704700505R\_\_\_\_\_



快異點企業有限公司

TEL: 03-4526538

FAX: 03-4614614

E-mail: [ideal508@ms35.hinet.net](mailto:ideal508@ms35.hinet.net)

網址: <http://www.lcdcable.com/>

部號	品名	規格	用量
A1	HOUSING	WL1058HL-30P或同等級FI-X30HL	1PCS
B1	TERMINAL	WL1058-G	27PCS
A2	HOUSING	HRS DF13-2*20P	1PCS
B2	TERMINAL	XS A1252-T	27PCS
C	WIRE	1571 28# 0.6	27PCS
D	編織網	168*0.12T	1PCS
E	套管	φ8.0	1PCS
F	CORE	4*6*2	10PCS

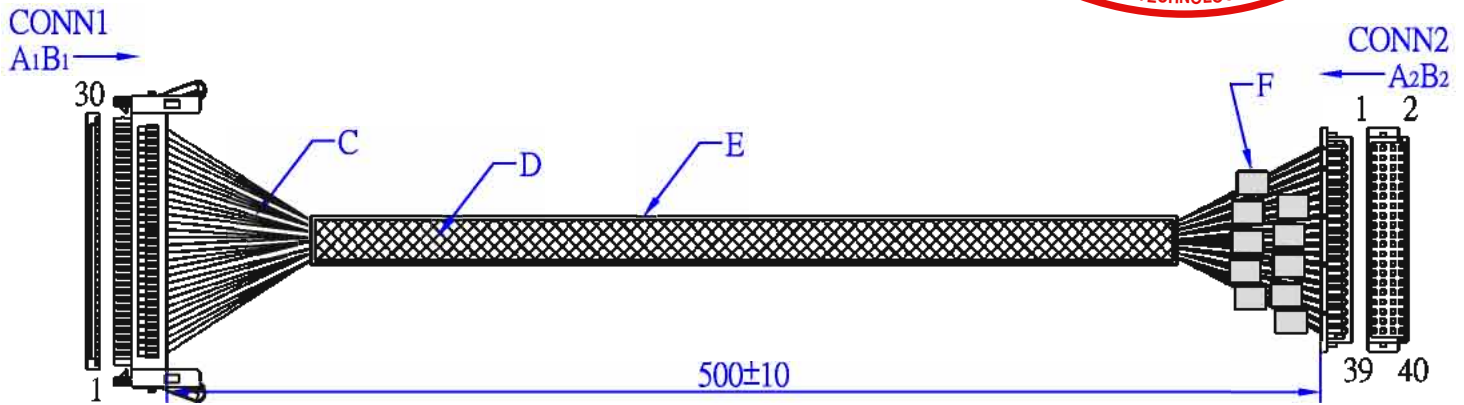

CONN1			CONN2	
PIN NO#	FUNCTION	COLOR	PIN NO#	FUNCTION
1	RX00-	黑	12	絞線+ TXOUT0#
2	RX00+	白	10	CORE TXOUT0
3	RX01-	棕	11	絞線+ TXOUT1#
4	RX01+	白	9	CORE TXOUT1
5	RX02-	紅	18	絞線+ TXOUT2#
6	RX02+	白	16	CORE TXOUT2
7	GND	黑	32	GND
8	RX0C-	橙	36	絞線+ TXCLK#
9	RX0C+	白	34	CORE TXCLK
10	RX03-	黃	17	絞線+ TXOUT3#
11	RX03+	白	15	CORE TXOUT3
12	RXE0-	綠	24	絞線+ E_TXOUT0#
13	RXE0+	白	22	CORE E_TXOUT0
14	GND	棕	38	GND
15	RXE1-	藍	23	絞線+ E_TXOUT1#
16	RXE1+	白	21	CORE E_TXOUT1
17	GND	紅	31	GND
18	RXE2-	紫	30	絞線+ E_TXOUT2#
19	RXE2+	白	28	CORE E_TXOUT2
20	RXEC-	灰	35	絞線+ E_TXCLK#
21	RXEC+	白	33	CORE E_TXCLK
22	RXE3-	粉	29	絞線+ E_TXOUT3#
23	RXE3+	白	27	CORE E_TXOUT3
24	GND	橙	37	GND
25	NC	-	-	-
26	NC	-	-	-
27	NC	-	-	-
28	5V	綠	2	+5V
29	5V	綠	2	+5V
30	5V	黃	4	+5V

備注:

客戶名稱	安勤科技股份有限公司	快異點企業有限公司			
客戶料號	E1704700505R	版次	A0	單位	MM
		料號	YAQ08061201	日期	2008-07-22

7 6 5 4 3 2 1

- HOUSING**
- Part No: WL1058-HL-30P
  - Material: PA-46, UL-94-V0
  - Shell: Copper alloy/Nickel Plated
  - Pitch: 1.0mm (0.39")
  - Poles: 30
  - Accepts Terminals : WL1058-G-P

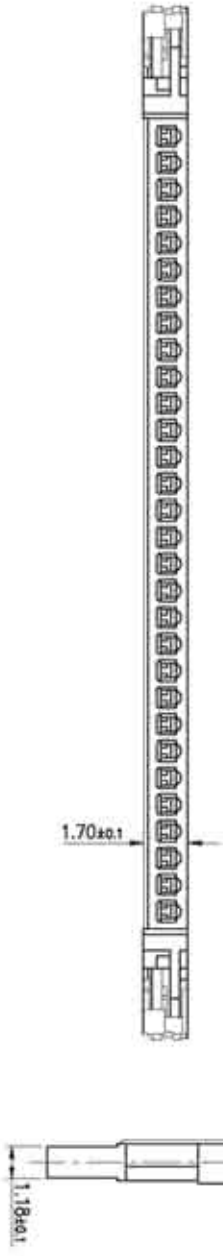
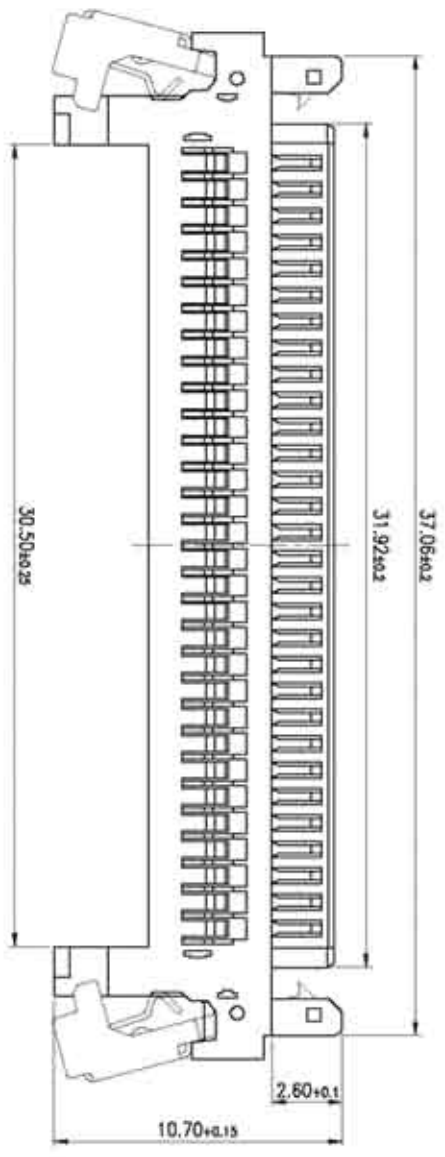

REVISIONS			
REV	DESCRIPTION	BY	DATE
1	PRIMARYLY		

MATERIAL		SURFACE TREATMENT		<b>WELL-LIN ENTERPRISE CO., LTD.</b> PART NO. WL1058-HL-30P TITLE 1.00mm(.039") CENTER HOUSING	
TOLERANCES UNLESS NOTED		ANGLES ±			
LINEAR ±	.0 ±0.25 .00 ±0.15 .000±0.08	2°		SCALE	SHEET 1 OF 1
				DESIGNER	CHECKED
				28.3.2012/01/23/06	M. J. 2011/01/23/06
				APPROVED	

7 6 5 4 3 2 1

# 測試報告 Test Report

號碼(No.): CE/2008/48104

日期(Date): 2008/05/06

頁數(Page): 1 of 7

維林企業有限公司

WELL-LIN ENTERPRISE CO., LTD.

台北縣新店市寶橋路235巷12號8樓

8F, NO. 12, LANE 235, PAO CHIAO RD., HSIN-TIEN CITY, TAIPEI HSIEN,

TAIWAN, R. O. C.



以下測試樣品係由客戶送樣，且由客戶聲稱並經客戶確認如下 (The following samples was/were submitted and identified by/on behalf of the client as):

樣品名稱(Sample Description) : IVORY WHITE NYLON PLASTIC  
 樣品型號(Style/Item No.) : 1019-H, 1058-H, 1058-HN, 1058-HNA, 1058-HL, 3500-H, 2510-H, 2530-H, 2500-H, 6100-H, 3040-H, 2550-H  
 收件日期(Sample Receiving Date) : 2008/04/28  
 測試期間(Testing Period) : 2008/04/28 TO 2008/05/06

測試需求(Test Requested) : 參照 RoHS 2002/95/EC 及其修定指令要求。(In accordance with the RoHS Directive 2002/95/EC, and its amendment directives).

測試方法(Test Method) : 參考 IEC 62321/2nd CDV (111/95/CDV) 方法檢測。(With reference to IEC 62321/2nd CDV (111/95/CDV). Procedures for the Determination of Levels of Regulated Substances in Electrotechnical Products).

- (1) 用感應耦合電漿原子發射光譜儀檢測鎘含量。 / Determination of Cadmium by ICP-AES.
- (2) 用感應耦合電漿原子發射光譜儀檢測鉛含量。 / Determination of Lead by ICP-AES.
- (3) 用感應耦合電漿原子發射光譜儀檢測汞含量。 / Determination of Mercury by ICP-AES.
- (4) 針對非金屬材質之樣品，用UV-VIS檢測六價鉻含量。 / Determination of Hexavalent Chromium for non-metallic samples by UV/Vis Spectrometry.
- (5) 以氣相層析儀/質譜儀檢測多溴聯苯和多溴聯苯醚含量。 / Determination of PEB and PBDE by GC/MS.

測試結果(Test Results) : 請見下一頁 (Please refer to next pages).

  
 Chenyu Kung / Operation Manager  
 Signed for and on behalf of  
 SGS TAIWAN LTD.  
 Chemical Laboratory – Taipei





# 測試報告 Test Report

號碼(No.): CE/2008/48104

日期(Date): 2008/05/06

頁數(Page): 2 of 7

維林企業有限公司

WELL-LIN ENTERPRISE CO., LTD.

台北縣新店市寶橋路235巷12號8樓

8F, NO. 12, LANE 235, PAO CHIAO RD., HSIN-TIEN CITY, TAIPEI HSIEN,

TAIWAN, R. O. C.



測試結果(Test Results) 單位(Unit): mg/kg

測試項目 (Test Items)	測試方法 Method (Refer to)	結果 (Result)	方法偵測 極限值 (MDL)	
		No.1		
鎘 / Cadmium (Cd)	(1)	n.d.	2	
鉛 / Lead (Pb)	(2)	8	2	
汞 / Mercury (Hg)	(3)	n.d.	2	
六價鉻 / Hexavalent Chromium Cr(VI) by alkaline extraction	(4)	n.d.	2	
多溴聯苯總和 / Sum of PBBs		n.d.	-	
一溴聯苯 / Monobromobiphenyl		n.d.	5	
二溴聯苯 / Dibromobiphenyl		n.d.	5	
三溴聯苯 / Tribromobiphenyl		n.d.	5	
四溴聯苯 / Tetrabromobiphenyl		n.d.	5	
五溴聯苯 / Pentabromobiphenyl		n.d.	5	
六溴聯苯 / Hexabromobiphenyl		n.d.	5	
七溴聯苯 / Heptabromobiphenyl		n.d.	5	
八溴聯苯 / Octabromobiphenyl		n.d.	5	
九溴聯苯 / Nonabromobiphenyl		n.d.	5	
十溴聯苯 / Decabromobiphenyl		n.d.	5	
多溴聯苯醚總和 (一至九溴) / Sum of PBDEs (Mono to Nona) (Note 4)		(5)	n.d.	-
一溴聯苯醚 / Monobromodiphenyl ether		n.d.	5	
二溴聯苯醚 / Dibromodiphenyl ether		n.d.	5	
三溴聯苯醚 / Tribromodiphenyl ether		n.d.	5	
四溴聯苯醚 / Tetrabromodiphenyl ether		n.d.	5	
五溴聯苯醚 / Pentabromodiphenyl ether		n.d.	5	
六溴聯苯醚 / Hexabromodiphenyl ether		n.d.	5	
七溴聯苯醚 / Heptabromodiphenyl ether		n.d.	5	
八溴聯苯醚 / Octabromodiphenyl ether		n.d.	5	
九溴聯苯醚 / Nonabromodiphenyl ether	n.d.	5		
十溴聯苯醚 / Decabromodiphenyl ether	n.d.	5		
多溴聯苯醚總和 (一至十溴) / Sum of PBDEs (Mono to Deca)	n.d.	-		

## 測試報告 Test Report

號碼(No.): CE/2008/48104

日期(Date): 2008/05/06

頁數(Page): 3 of 7

維林企業有限公司

WELL-LIN ENTERPRISE CO., LTD.

台北縣新店市寶橋路235巷12號8樓

8F, NO. 12, LANE 235, PAO CHIAO RD., HSIN-TIEN CITY, TAIPEI HSIEN,  
TAIWAN, R. O. C.



### 測試部位描述 (TEST PART DESCRIPTION):

NO.1 : 米色塑膠 (BEIGE PLASTIC)

### 備註(Note):

1. mg/kg = ppm
2. n.d. = Not Detected (未檢出)
3. MDL = Method Detection Limit (方法偵測極限值)
4. 根據2005年10月13日歐盟會議公佈2005/717/EC, 修訂2002/95/EC內容, 通過解除高分子材質中十溴聯苯醚之使用限制. (According to 2005/717/EC DecaBDE is exempt.)
5. "-" = Not Regulated (無規格值)



# 測試報告 Test Report

號碼(No.): CE/2008/48104

日期(Date): 2008/05/06

頁數(Page): 4 of 7

維林企業有限公司

WELL-LIN ENTERPRISE CO., LTD.

台北縣新店市寶橋路235巷12號8樓

8F, NO. 12, LANE 235, PAO CHIAO RD., HSIN-TIEN CITY, TAIPEI HSIEN,

TAIWAN, R. O. C.



- 1) 根據以下的流程圖之條件，樣品已完全溶解。(六價鉻測試方法除外) / These samples were dissolved totally by pre-conditioning method according to below flow chart. (Cr<sup>6+</sup> test method excluded)
- 2) 測試人員：張啓興 / Name of the person who made measurement: Troy Chang
- 3) 測試負責人：龔振裕 / Name of the person in charge of measurement: Chenyu Kung

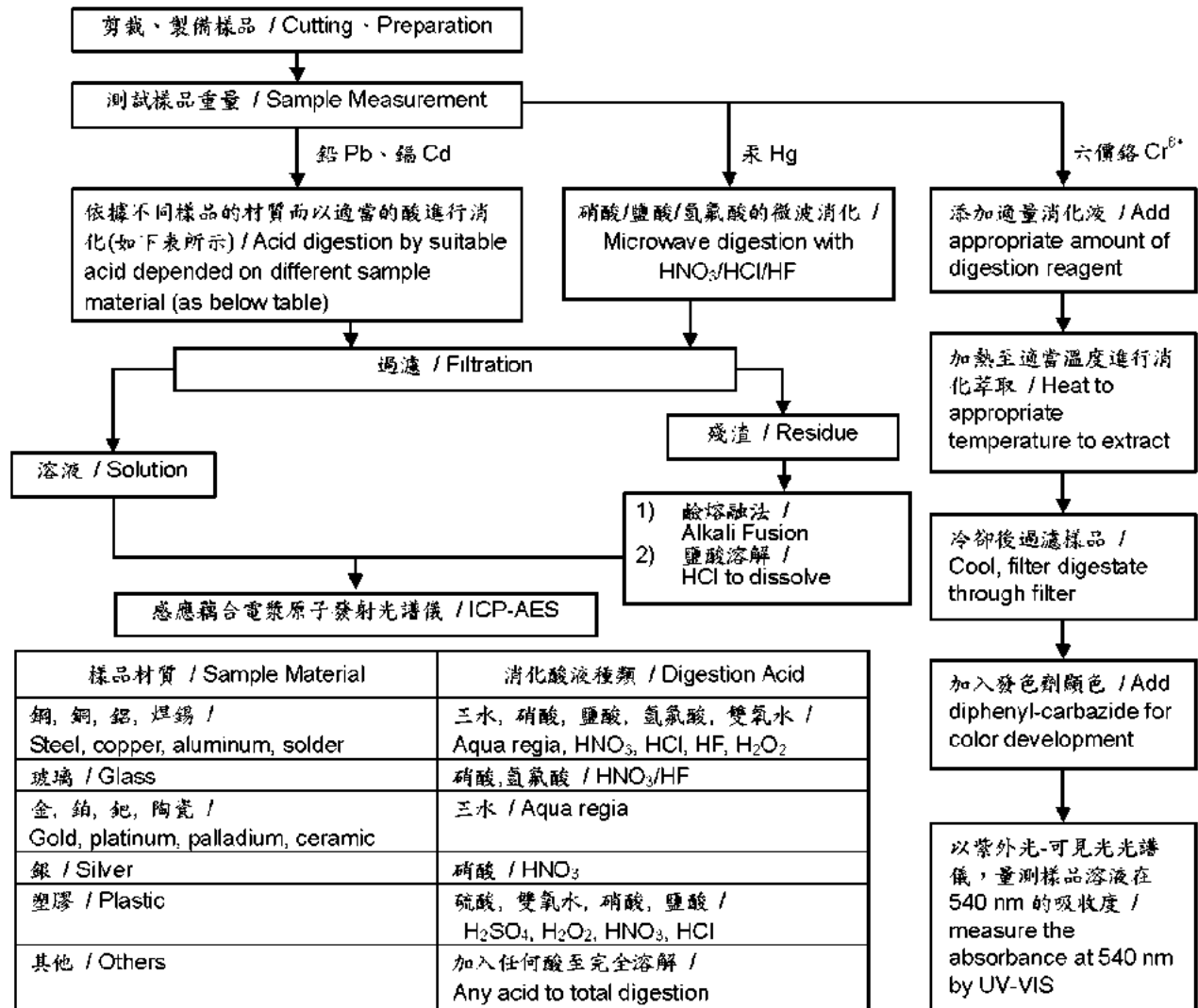

# 測試報告 Test Report

號碼(No.): CE/2008/48104

日期(Date): 2008/05/06

頁數(Page): 5 of 7

維林企業有限公司

WELL-LIN ENTERPRISE CO., LTD.

台北縣新店市寶橋路235巷12號8樓

8F, NO. 12, LANE 235, PAO CHIAO RD., HSIN-TIEN CITY, TAIPEI HSIEN,

TAIWAN, R. O. C.



## 多溴聯苯/多溴聯苯醚分析流程圖 / PBB/PBDE analytical FLOW CHART

- 初次測試程序 / First testing process →
- 選擇性篩檢程序 / Optional screen process .....
- 確認程序 / Confirmation process - - - - -

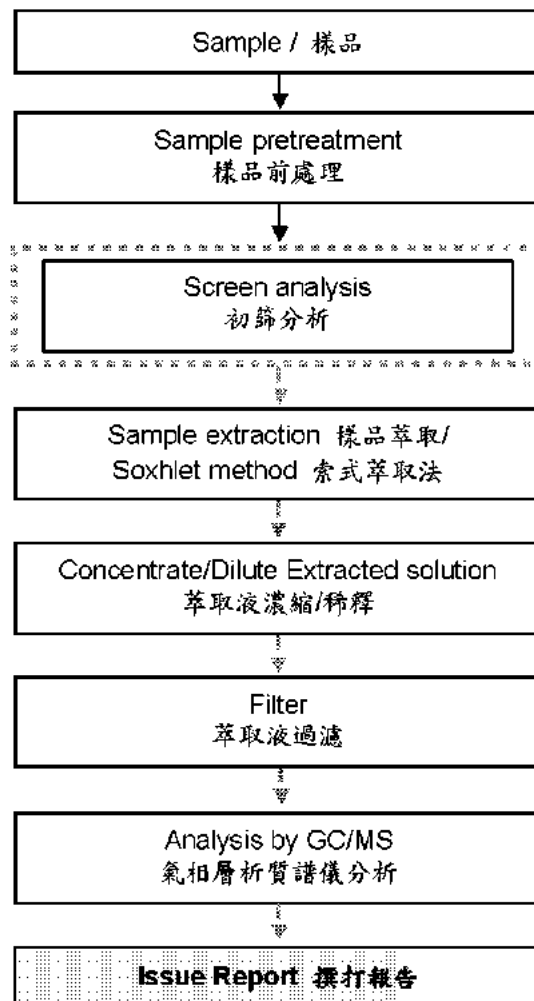

## 測試報告 Test Report

號碼(No.): CE/2008/48104

日期(Date): 2008/05/06

頁數(Page): 6 of 7

維林企業有限公司

WELL-LIN ENTERPRISE CO., LTD.

台北縣新店市寶橋路235巷12號8樓

8F, NO. 12, LANE 235, PAO CHIAO RD., HSIN-TIEN CITY, TAIPEI HSIEN,

TAIWAN, R. O. C.



CE / 2008 / 48104

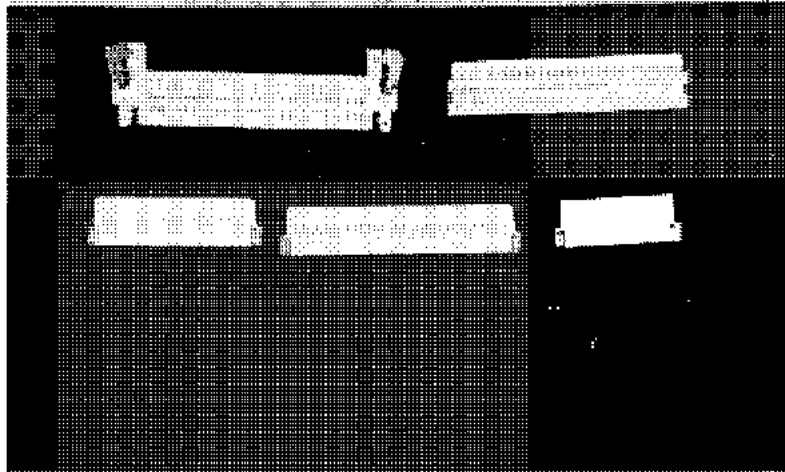

CE / 2008 / 48104

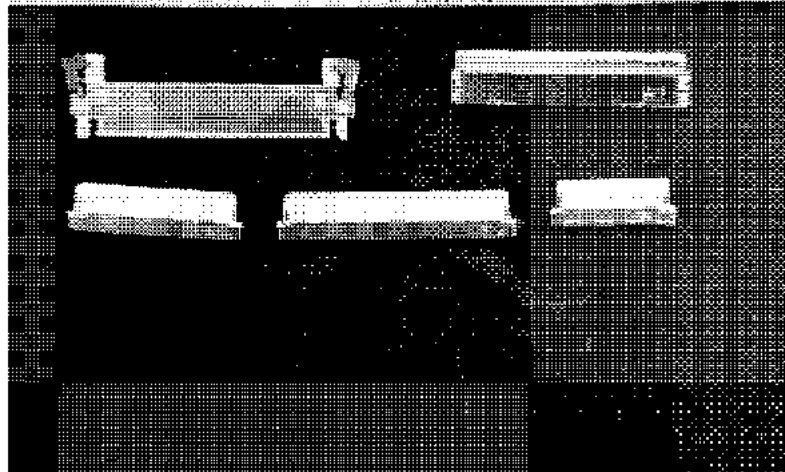

## 測試報告 Test Report

號碼(No.): CE/2008/48104

日期(Date): 2008/05/06

頁數(Page): 7 of 7

維林企業有限公司

WELL-LIN ENTERPRISE CO., LTD.

台北縣新店市寶橋路235巷12號8樓

8F, NO. 12, LANE 235, PAO CHIAO RD., HSIN-TIEN CITY, TAIPEI HSIEN,

TAIWAN, R. O. C.

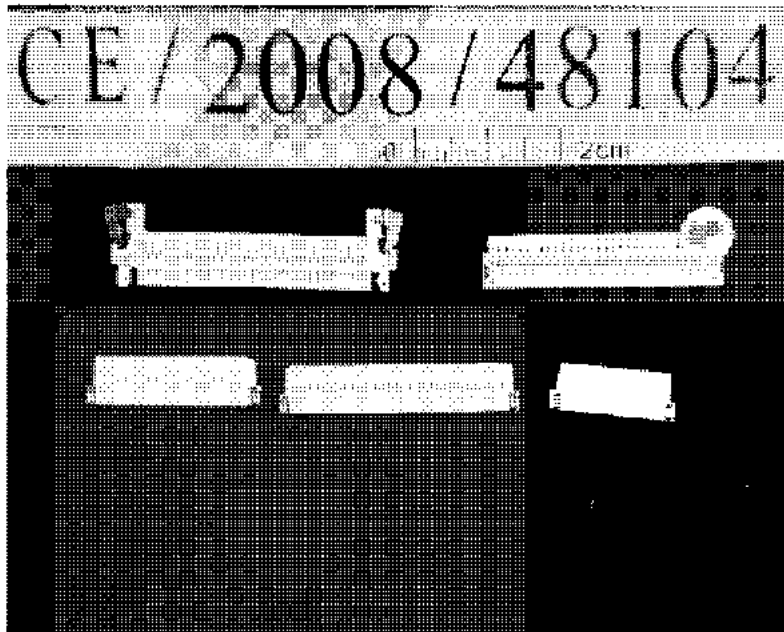

\*\* 報告結尾 \*\*



REVISIONS			
REV	DESCRIPTION	BY	DATE
1	PRIMARILY		
2	REVISED		01/09/91

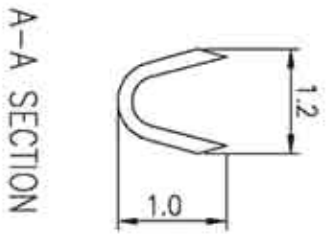
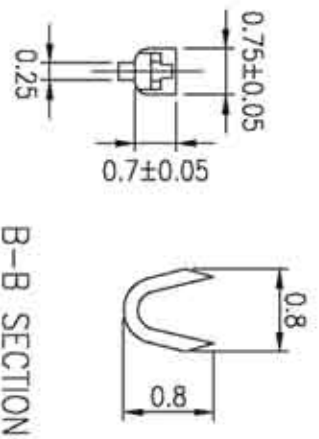
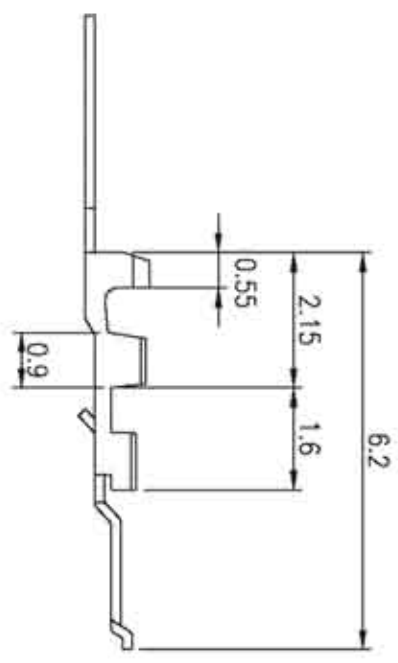
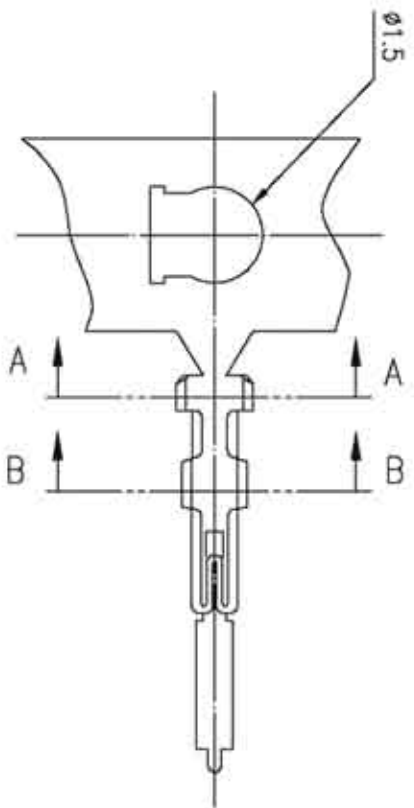

- TERMINAL**
- Part No: WL1058-G-P
  - Material: Phos. bronze
  - Thickness: 0.15mm
  - Plating: Gold plated 10u"
  - Wire Range: Suitable for AWG#28-32
  - Insulation O.D: 0.8mm (max)
  - QTY: 15,000 pcs/roll
  - Accepts housing: WL1058-H-XXX



MATERIAL	
SURFACE TREATMENT	
TOLERANCES UNLESS NOTED	
LINEAR ±	.0 ±0.25 .00 ±0.15 .000±0.08
ANGLES ±	2'

**WELL-LIN ENTERPRISE CO., LTD.**

PART NO. WL1058-G-P

TITLE MINI-CRIMP 1.0mm TERMINAL

DESIGNER 9/3 2008/03/01

CHECKED

APPROVED 08/03/01

SCALE 10/1

SHEET 1 OF 1

Metric S

THIRD ANGLE PROJECTION

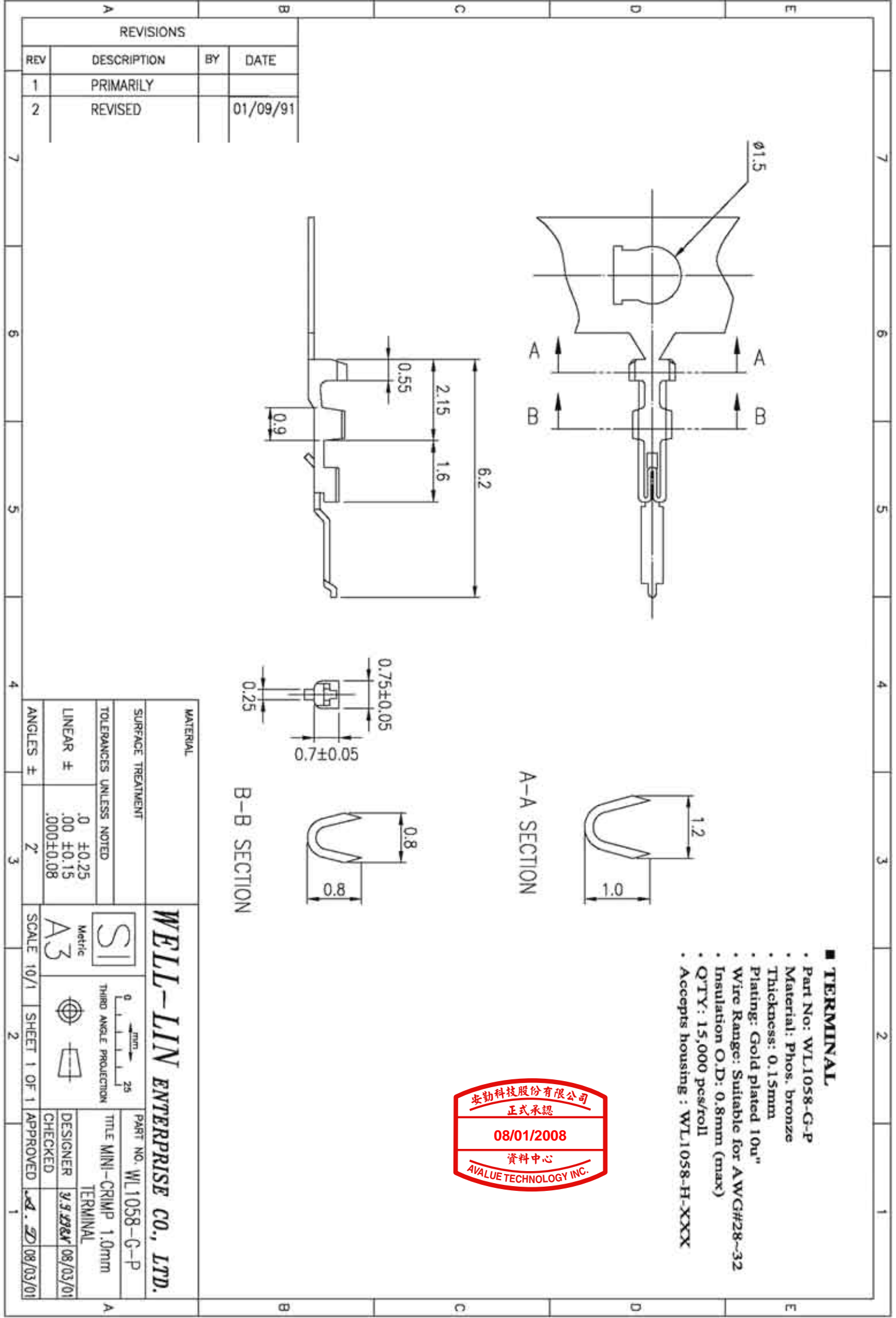

# 測試報告 Test Report

號碼(No.): CE/2008/40770      日期(Date): 2008/04/10      頁數(Page): 1 of 4

維林企業有限公司  
 WELL-LIN ENTERPRISE CO., LTD.  
 台北縣新店市寶橋路235巷12號8樓  
 8F, NO. 12, LANE 235, PAO CHIAO RD., HSIN-TIEN CITY, TAIPEI HSIEN,  
 TAIWAN, R. O. C.



以下測試樣品係由客戶送樣，且由客戶聲稱並經客戶確認如下 (The following samples was/were submitted and identified by/on behalf of the client as):

樣品名稱(Sample Description) : 磷青銅 (PHOSPHOR BRONZE)  
 收件日期(Sample Receiving Date) : 2008/04/02  
 測試期間(Testing Period) : 2008/04/02 TO 2008/04/10

- =====  
 =====
- 測試需求(Test Requested)** : 參照 RoHS 2002/95/EC 及其修定指令要求. (In accordance with the RoHS Directive 2002/95/EC, and its amendment directives).
- 測試方法(Test Method)** : 參考 IEC 62321/2nd CDV (111/95/CDV) 方法檢測. (With reference to IEC 62321/2nd CDV (111/95/CDV). Procedures for the Determination of Levels of Regulated Substances in Electrotechnical Products).
- (1) 用感應耦合電漿原子發射光譜儀檢測鎘含量. / Determination of Cadmium by ICP-AES.
  - (2) 用感應耦合電漿原子發射光譜儀檢測鉛含量. / Determination of Lead by ICP-AES.
  - (3) 用感應耦合電漿原子發射光譜儀檢測汞含量. / Determination of Mercury by ICP-AES.
  - (4) 針對金屬材質之樣品，用 Spot test / Colorimetric 方法檢測六價鉻含量. / Determination of Hexavalent Chromium for metallic samples by Spot test / Colorimetric Method.
- 測試結果(Test Results)** : 請見下一頁 (Please refer to next pages).



*Nicole Chien*  
 Nicole Chien / Supervisor  
 Signed for and on behalf of  
 SGS TAIWAN LTD.  
 Chemical Laboratory - Taipei



# 測試報告 Test Report

號碼(No.): CE/2008/40770

日期(Date): 2008/04/10

頁數(Page): 2 of 4

維林企業有限公司

WELL-LIN ENTERPRISE CO., LTD.

台北縣新店市寶橋路235巷12號8樓

8F, NO. 12, LANE 235, PAO CHIAO RD., HSIN-TIEN CITY, TAIPEI HSIEN,  
TAIWAN, R. O. C.



測試結果(Test Results) 單位(Unit): mg/kg

測試項目 (Test Items)	測試方法 Method (Refer to)	結果 (Result)	方法偵測 極限值 (MDL)
		No.1	
鎘 / Cadmium (Cd)	(1)	n.d.	2
鉛 / Lead (Pb)	(2)	15	2
汞 / Mercury (Hg)	(3)	n.d.	2
六價鉻 / Hexavalent Chromium Cr(VI) by Spot test / boiling water extraction	(4)	Negative	See Note 4

**測試部位描述 (TEST PART DESCRIPTION):**

NO.1 : 銅色金屬 (COPPER COLORED METAL)

**備註(Note):**

1. mg/kg = ppm
2. n.d. - Not Detected (未檢出)
3. MDL = Method Detection Limit (方法偵測極限值)
4. Spot-test:

Negative = Absence of Cr(VI) coating / surface layer(鍍層中偵測不到六價鉻),  
Positive = Presence of Cr(VI) coating / surface layer(鍍層中偵測到六價鉻);  
The tested sample should be further verified by boiling-water-extraction method if the  
spot test result cannot be confirmed.

(當該測項無法確認時, 測試樣品可藉由boiling-water-extraction測試方法進一步確認)

**Boiling-water-extraction:**

Negative = Absence of Cr(VI) coating / surface layer(鍍層中偵測不到六價鉻),  
Positive = Presence of Cr(VI) coating / surface layer(鍍層中偵測到六價鉻);  
the detected concentration in boiling-water-extraction solution is equal or  
greater than 0.02 mg/kg with 50 cm<sup>2</sup> sample surface area.  
該溶液濃度 ≥ 0.02 mg/kg with 50 cm<sup>2</sup> (sample surface area)



# 測試報告 Test Report

號碼(No.): CE/2008/40770

日期(Date): 2008/04/10

頁數(Page): 3 of 4

維林企業有限公司

WELL-LIN ENTERPRISE CO., LTD.

台北縣新店市寶橋路235巷12號8樓

8F, NO. 12, LANE 235, PAO CHIAO RD., HSIN-TIEN CITY, TAIPEI HSIEN,

TAIWAN, R. O. C.



- 1) 根據以下的流程圖之條件，樣品已完全溶解。(六價鉻測試方法除外) / These samples were dissolved totally by pre-conditioning method according to below flow chart. (Cr<sup>6+</sup> test method excluded)
- 2) 測試人員：張啓興 / Name of the person who made measurement: Troy Chang
- 3) 測試負責人：龔振裕 / Name of the person in charge of measurement: Chenyu Kung

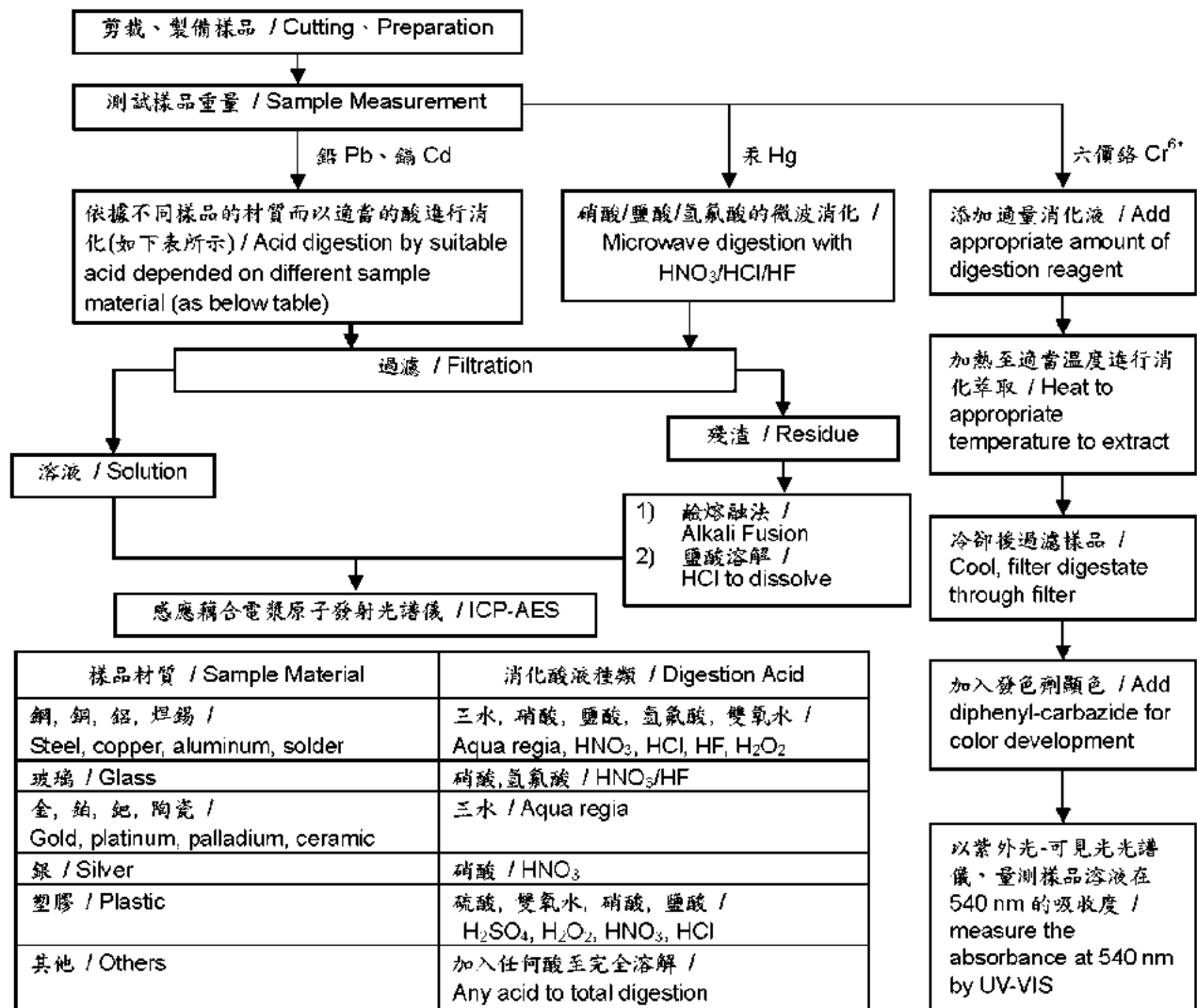

## 測試報告 Test Report

號碼(No.): CE/2008/40770

日期(Date): 2008/04/10

頁數(Page): 4 of 4

維林企業有限公司

WELL-LIN ENTERPRISE CO., LTD.

台北縣新店市寶橋路235巷12號8樓

8F, NO. 12, LANE 235, PAO CHIAO RD., HSIN-TIEN CITY, TAIPEI HSIEN,  
TAIWAN, R. O. C.



# CE/2008/40770

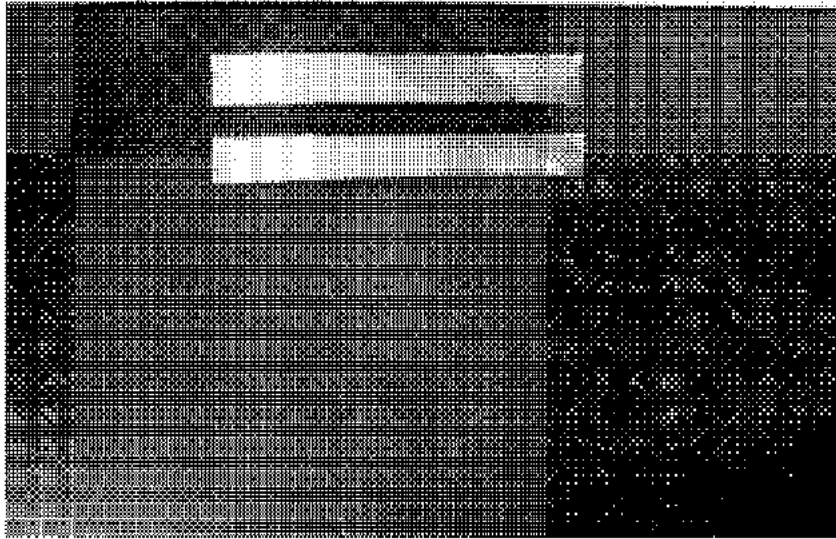

\*\* 報告結尾 \*\*



# 測試報告 Test Report

號碼(No.): CE/2008/45213

日期(Date): 2008/04/24

頁數(Page): 1 of 4

維林企業有限公司

WELL-LIN ENTERPRISE CO., LTD.

台北縣新店市寶橋路235巷12號8樓

8F, NO. 12, LANE 235, PAO CHIAO RD., HSIN-TIEN CITY, TAIPEI HSIEN.

TAIWAN, R. O. C.

以下測試樣品係由客戶送樣，且由客戶聲稱並經客戶確認如下 (The following samples was/were submitted and identified by/on behalf of the client as):

樣品名稱(Sample Description) : 鍍金電鍍層  
收件日期(Sample Receiving Date) : 2008/04/17  
測試期間(Testing Period) : 2008/04/17 TO 2008/04/24

測試需求(Test Requested) : 參照 RoHS 2002/95/EC 及其修定指令要求。(In accordance with the RoHS Directive 2002/95/EC, and its amendment directives).

測試方法(Test Method) : 參考 IEC 62321/2nd CDV (111/95/CDV) 方法檢測。(With reference to IEC 62321/2nd CDV (111/95/CDV), Procedures for the Determination of Levels of Regulated Substances in Electrotechnical Products).

- (1) 用感應耦合電漿原子發射光譜儀檢測鎘含量。 / Determination of Cadmium by ICP-AES.
- (2) 用感應耦合電漿原子發射光譜儀檢測鉛含量。 / Determination of Lead by ICP-AES.
- (3) 用感應耦合電漿原子發射光譜儀檢測汞含量。 / Determination of Mercury by ICP-AES.
- (4) 針對金屬材質之樣品，用 Spot test / boiling water extraction 方法檢測六價鉻含量。 / Determination of Hexavalent Chromium for metallic samples by Spot test / boiling water extraction Method.

測試結果(Test Results) : 請見下一頁 (Please refer to next pages).

  
Nicole Chien / Supervisor  
Signed for and on behalf of  
SGS TAIWAN LTD.  
Chemical Laboratory - Taipei



# 測試報告 Test Report

號碼(No.): CE/2008/45213

日期(Date): 2008/04/24

頁數(Page): 2 of 4

維林企業有限公司

WELL-LIN ENTERPRISE CO., LTD.

台北縣新店市寶橋路235巷12號8樓

8F, NO. 12, LANE 235, PAO CHIAO RD., HSIN-TIEN CITY, TAIPEI HSIEN.

TAIWAN, R. O. C.



測試結果(Test Results) 單位(Unit): mg/kg

測試項目 (Test Items)	測試方法 Method (Refer to)	結果 (Result)	方法偵測 極限值 (MDL)
		No.1	
鎘 / Cadmium (Cd)	(1)	n.d.	2
鉛 / Lead (Pb)	(2)	20	2
汞 / Mercury (Hg)	(3)	n.d.	2
六價鉻 / Hexavalent Chromium Cr(VI) by Spot test / boiling water extraction	(4)	Negative	See Note 4

**測試部位描述 (TEST PART DESCRIPTION):**

NO.1 : 金色金屬鍍層 (PLATING LAYER OF GOLDEN COLORED METAL)

**備註(Note):**

1. mg/kg = ppm
2. n.d. - Not Detected (未檢出)
3. MDL = Method Detection Limit (方法偵測極限值)
4. Spot-test:

Negative = Absence of Cr(VI) coating / surface layer(鍍層中偵測不到六價鉻),  
Positive = Presence of Cr(VI) coating / surface layer(鍍層中偵測到六價鉻);  
The tested sample should be further verified by boiling-water-extraction method if the  
spot test result cannot be confirmed.

(當該測項無法確認時, 測試樣品可藉由boiling-water-extraction測試方法進一步確認)

**Boiling-water-extraction:**

Negative = Absence of Cr(VI) coating / surface layer(鍍層中偵測不到六價鉻),  
Positive = Presence of Cr(VI) coating / surface layer(鍍層中偵測到六價鉻);  
the detected concentration in boiling-water-extraction solution is equal or  
greater than 0.02 mg/kg with 50 cm<sup>2</sup> sample surface area.  
該溶液濃度 ≥ 0.02 mg/kg with 50 cm<sup>2</sup> (sample surface area)



# 測試報告 Test Report

號碼(No.): CE/2008/45213

日期(Date): 2008/04/24

頁數(Page): 3 of 4

維林企業有限公司

WELL-LIN ENTERPRISE CO., LTD.

台北縣新店市寶橋路235巷12號8樓

8F, NO. 12, LANE 235, PAO CHIAO RD., HSIN-TIEN CITY, TAIPEI HSIEN.

TAIWAN, R. O. C.



- 1) 根據以下的流程圖之條件，樣品已完全溶解。(六價鉻測試方法除外) / These samples were dissolved totally by pre-conditioning method according to below flow chart. (Cr<sup>6+</sup> test method excluded)
- 2) 測試人員：張啓興 / Name of the person who made measurement: Troy Chang
- 3) 測試負責人：龔振裕 / Name of the person in charge of measurement: Chenyu Kung

## 鍍層重金屬測試流程圖 / Flow Chart of Stripping method for metal analysis

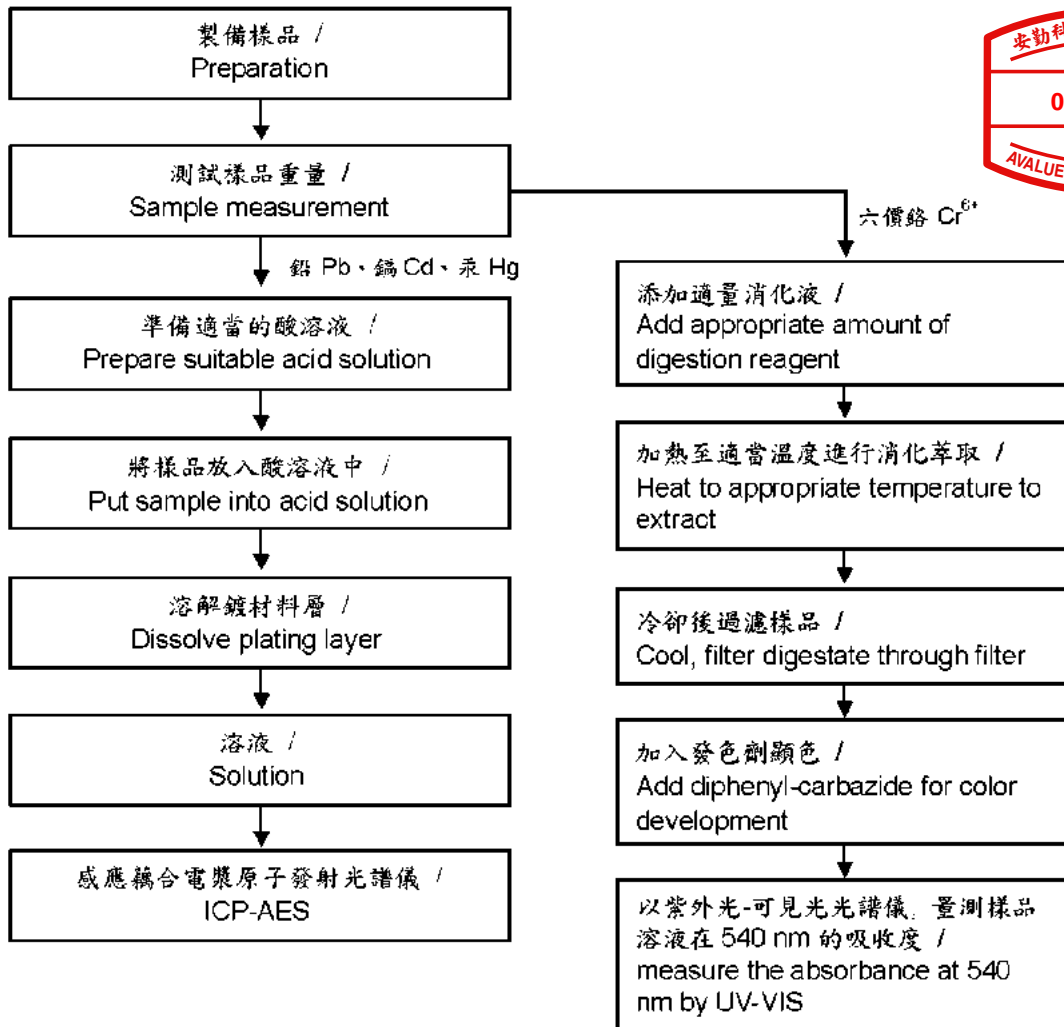

## 測試報告 Test Report

號碼(No.): CE/2008/45213

日期(Date): 2008/04/24

頁數(Page): 4 of 4

維林企業有限公司

WELL-LIN ENTERPRISE CO., LTD.

台北縣新店市寶橋路235巷12號8樓

8F, NO. 12, LANE 235, PAO CHIAO RD., HSIN-TIEN CITY, TAIPEI HSIEN.

TAIWAN, R. O. C.

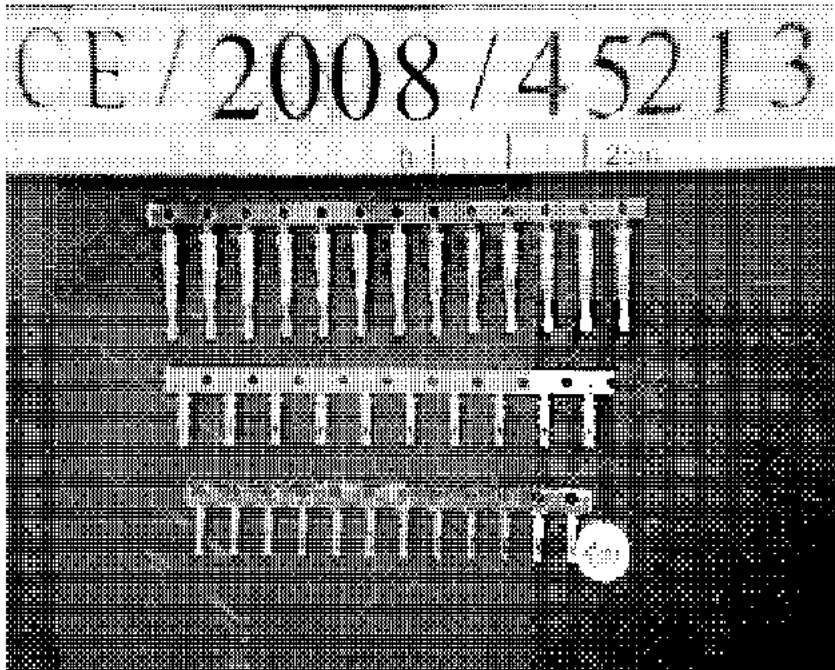

\*\* 報告結尾 \*\*







## Single Row Socket

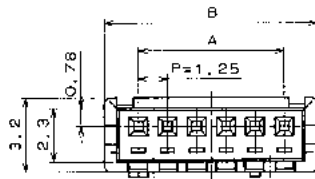
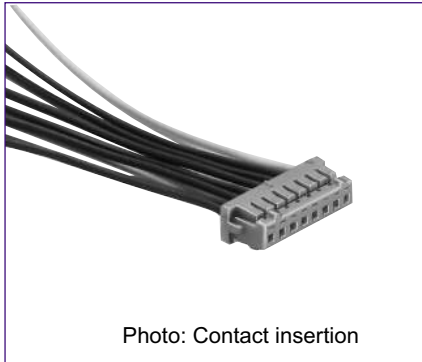

[Specific No.] - \*\*, (\*\*)  
 Blank: 1 bag: 100 pcs.

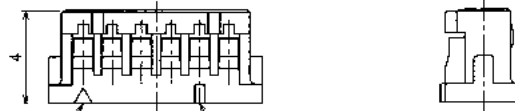

Contact No.1 mark      Marking per 5 contacts

Unit: mm

Part Number	CL No.	Number of Contacts	A	B	Part Number	CL No.	Number of Contacts	A	B
DF13-2S-1.25C(**)	536-0001-4**	2	1.25	4.15	DF13- 9S-1.25C(**)	536-0008-3**	9	10.00	12.90
DF13-3S-1.25C(**)	536-0002-7**	3	2.50	5.40	DF13-10S-1.25C(**)	536-0009-6**	10	11.25	14.15
DF13-4S-1.25C(**)	536-0003-0**	4	3.75	6.65	DF13-11S-1.25C(**)	536-0010-5**	11	12.50	15.40
DF13-5S-1.25C(**)	536-0004-2**	5	5.00	7.90	DF13-12S-1.25C(**)	536-0011-8**	12	13.75	16.65
DF13-6S-1.25C(**)	536-0005-5**	6	6.25	9.15	DF13-14S-1.25C(**)	536-0013-3**	14	16.25	19.15
DF13-7S-1.25C(**)	536-0006-8**	7	7.50	10.40	DF13-15S-1.25C(**)	536-0014-6**	15	17.50	20.40
DF13-8S-1.25C(**)	536-0007-0**	8	8.75	11.65					

Note 1. The quantity at the specific No. "None" is delivered per bag (100 pcs.). If needed, please select and order the products per bag.

## Double Row Socket

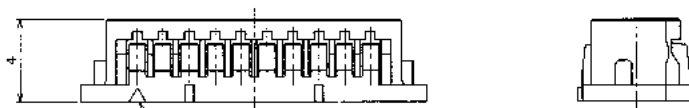
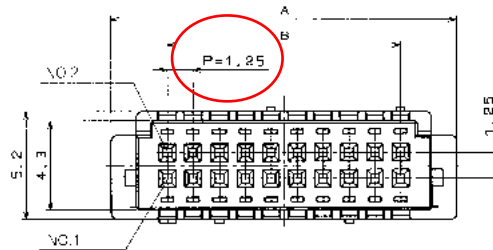
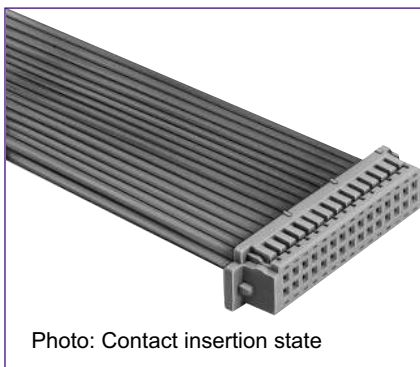

Contact No.1 mark

Unit: mm

Part Number	CL No.	Number of Contacts	A	B	[Specific No.] - **, (**) Blank: 1 bag: 100 pcs.
DF13-10DS-1.25C(**)	536-0550-2**	10	10.40	5.00	
DF13-20DS-1.25C(**)	536-0555-6**	20	16.65	11.25	
DF13-30DS-1.25C(**)	536-0560-6**	30	22.90	17.50	
DF13-40DS-1.25C(**)	536-0565-0**	40	29.15	23.75	

Note: The quantity at the specific No. "Blank" is delivered per bag (100pcs). If needed, please select and order the products per bag.

## ■Crimping Contact

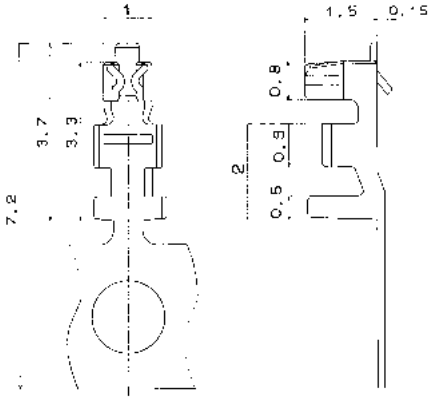

Part Number	CL No.	Packaging Type	Quantity	Finish
DF13-2630SCF	536-0300-5	Reel	10,000	Tin plating
DF13-2630SCFA	536-0298-5	Reel	10,000	Gold plating

### ●Applicable Cable (Tin Plating Annealed Copper Wire)

Conductor Size (Wire construction)	Jacket Diameter
AWG26(7 cores./0.16mm)	φ0.65 to φ1.0mm
AWG28(7 cores./0.127mm)	
AWG30(7 cores./0.1mm)	

Note: If other cables are used instead of the applicable cable, please contact the Hirose sales department.

### ●Recommended Cable

UL1571

### ●Strip Length

1.2 to 1.9mm

## ◆Applicable Crimping Tool

Type	Part Number	CL No.	Applicable Contact
Applicator	AP105-DF13-2630S	901-4531-9	DF13-2630SCF/SCFA
Press Main Unit	CM-105	901-0005-4	_____
Manual Crimping Tool	DF13-TB2630HC	550-0256-1	DF13-2630SCF
Extraction Tool	DF-C-PO(B)	550-0179-2	DF13-2630SCF

Note 1. If a trouble has occurred due to other tools, which are not designated by Hirose, Hirose won't guarantee any product.

Note 2. The manual crimping tool is used to sequentially cut the reel contact with carrier.

## ◆Application Pattern

	SMT (Single Row Product)	Through hole (Single Row Product)	SMT (Double Row Product)
Right Angle			
Straight			

Attn.: \_\_\_\_\_

**HIROSE ELECTRIC CO., LTD.**

5-23, OSAKI 5-CHOME, SHINAGAWA-KU, TOKYO, JAPAN

## Notice of Product Supply with Specifications that Conform to the RoHS Directive

Based upon the needs of our customers to conform to the European Directive (Restriction of the Use of Certain Hazardous Substances in Electrical and Electronic Equipment), Hirose Electric will modify our product offering with the introduction of RoHS compliant products. As a general rule, unless specified otherwise by the customer, Hirose Electric will transition to RoHS compliant products in accordance with the schedule shown below:

Thank you in advance for your cooperation.



### 1. Currently Affected Series

Transition Order	Affected series (Summary)
First Transition	DF5, HIF3FC(HIF3FB), SD(Dsub)
Second Transition	DF11, DF12, DF15, DF17, DF1B, DF3, Dsub, FX2, FX2B, HIF2B, HIF6, HRM, HSC, ID1, MQ178, PCN10
Third Transition	A3E, DF18, DF23, DM1, HIF4, HMKS, HSCPJAT, IC11, MDF76, MS151, OPTTM, QR/P, TM, U.FL, UM, W·FL
Fourth Transition	1600, DF13, DF14, DF19, DF20, DF29, HRFC, IC13, MCN, MCR, MD, MF, PO40G, TM with leads, XPI

Representative products are indicated above. Please see supplementary sheet for details.

### 2. List of Affected Products for Your Company and RoHS Compliant Products (Substitute Products)

Supplementary Sheet (2) or electronic file data

You will be contacted individually by an account representative at a later date.

### 3. Delivery Starting Date with Specifications that Conform to the RoHS Directive

Transition Order	Starting Date for Accepting Orders	Starting Date for Delivery	Last Day for Accepting Orders of Old Products
First Transition	July 11	September 1	September 1
Second Transition	August 22	October 17	October 17
Third Transition	August 22	November 14	November 14
Fourth Transition	August 22	December 12	December 12

Please order with a delivery date that follows "the Starting Date for Delivery".

**4. Scheduled Date for Commencing Supply to Your Company**

Preparations are being made with the aim of delivering samples 2 months prior to the starting date for delivery.

Adjustments will be made individually for customers who desire to make purchases of substitute products prior to the aforementioned dates.

**5. Required Drawings and Documentation for the Transition**

Upon your request, this information will be submitted to you by your Hirose Electric account representative.

If you would like clarification concerning any of the points, please contact your Hirose Electric account representative.

Please contact us as soon as possible if this change is in anyway unacceptable to your company.

Please be sure to contact us no later than one month prior to the given effective date. Any time after that, the shipment of the modified product will begin.



Document Receipt

(Customer→Hirose Electric business representative)

## Notice of Product Supply with Specifications that Conform to the RoHS Directive

We have received the aforementioned document.

- Customer's name:
  
- Received stamp (or signature):

-----  
(Cut on this line)



## Transition order for RoHS compliant products

### 1. First Transition

Series name

DF5  
HIF3FC(HIF3FB)  
SD(Dsub)

### 2. Second Transition

Series name	Series name	Series name
A1	FX2B	HIF6R
A2	FX2M3	HMU
A3	FX2M6	HNC
A4	FX4	HRM
BNC	FX5	HSC
CR22	FX6	IC7
DF1	FX8	IC9
DF11	FX8C	ID1
DF12	HDH	MDF14A
DF15	HIF2B	MDF7
DF17	HIF2C	MI20,MI21
DF1B	HIF2E	MIF
DF1E	HIF3	MIF84
DF2	HIF3A	MQ178
DF21	HIF3B	MQ198
DF3	HIF3BA*PD	PCN10
DF35	HIF3C	PCN11
DF4	HIF3E	PCN12
DF6	HIF3F	PCN13
DF9(Except DF9M, DF9R)	HIF3G	RD(Dsub)
Dsub	HIF3H	ST
FX10	HIF6	
FX11	HIF6A	
FX2	HIF6H	

### 3. Third Transition

Series name	Series name	Series name
3200	HDM	MR
A3E	HIF12	MS151
AT	HIF4	MSS
AT100	HIF5	N
AT1100	HIF7	N.UM
AT2200	HLS	NFA
BNCTM	HMKS	OPTTM
BWA	HP5,HP6	PAT
C/D	HRMTM	PCN10F
CR7	HSCPJAT	PCN21
DF10	IC1	PL71
DF16	IC11S	PL72
DF18	IC14	PO51
DF23	ID2	PO51M
DF24	MA	PO6
DF7	MA18	PO62
DM1	MA43	PO82M
DX	MA44	POD
DX*LM	MCR60	POD1
DX*M	MCX	POD4
E.FL	MDF6	S.FL
EX	MDF76	S.FL2



EX*T	MMCX	SX3
EX80	MQ138	SX4
FI	MQ165	TM
FX1	MQ172	U.FL
H.FL	MQ203	UM
HCS	MQ212	W.FL

#### 4. Fourth Transition

Series name	Series name	Series name
1300	HCD	ML
1600	HDAST	MP
1700	HDC	MPC
2400	HDN	MQ115
3100	HE	MQ196
3300	HFDI	MQ38
3500	HFH	MQ41
3CV	HIF1	MRF
A5	HIF8	MRF01
AT1000	HIF9	MRF03
AT1200	HMB	MRF1.6/5.6
AT1300	HMUPAT	MS
AT1500	HMUPJAT	MS136
AT1800	HRFC	NC
AT1900	HRFCPJAT	NF
AT200	HRLA	NX
AT2300	HRLC	OMB
AT300	HRMM	PCN5
AT400	HRMRPA	PF2
AT500	HRMTMSL	PL
AT600	HRPI	PO
AT900	HSCAT11CS	PO(ST)
CB1	HT	PO21
CG	HTH	PO21M
CR10	HTRB	PO40G
CR13	HVTM	PO55
CR21	HX2	PO5G
CTB	IC	PO72
DF13	IC13	PO73
DF14	LX	POB
DF19	M	POD3
DF20	MAT	PS
DF22	MCN	PX
DF26	MCR	QF1
DF29	MCR104	QM
DF9M-R	MCR69	RC
DL2	MCR84	S
DL3	MCR89	SPO
DL5	MD	TM( with cable)
DN	MDF12	TNC
DN2	MDF27	TWA
EX60B	MDF8	TWPOD4
EZ	MDF83	TWT2
FL	MDF99	XPI
HB	MF	
HC	MF10	



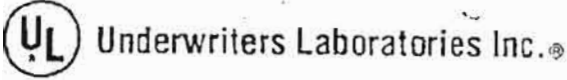

Northbrook, Illinois • (847) 272-8800  
 Melville, New York • (516) 271-5200  
 Santa Clara, California • (408) 985-2400  
 Research Triangle Park,  
 North Carolina • (919) 549-1400  
 Camas, Washington • (360) 817-5500



UBE INDUSTRIES LTD  
 C/O SPRINGBORN TESTING & RESEARCH INC  
 MR A J KARSZES  
 10 WATER ST  
 ENFIELD CT 06082

REC'D JUL 28 1997

Your most recent listing is shown below. Please review this information and report any inaccuracies to the UL Engineering staff member who handled your UL project.

QMFZ2 April 16, 1985  
 Component - Plastics

TORAY INDUSTRIES INC

E41797 (M)  
 (B1A-cont. from B1 card)

UTN121, U121	All	0.062 (1.57) 0.123 (3.12)	65 65	65 65	65 65	— 94HB — 94HB	—	—	—	—
Polyamide, Type 66 nylon (PA66), furnished in the form of pellets.										
*3001 N, 3007	All	0.028 (0.71) 0.058 (1.47) 0.120 (3.05)	105 105 105	— 75 75	— 85 85	9 94V-2 12 94V-2 22 94V-2	200 + 200 + 200 +	0.4 0.3 0.3	— — 116	— — 600 +
UTN320, U320	All	0.062 (1.57) 0.123 (3.12) 0.015 (0.38)	65 65 65	65 65 —	65 65 —	— 94HB — 94HB — 94V-0	— — —	— — —	— — —	— — —
*3004-VU	All	0.026 (0.66) 0.061 (1.55) 0.120 (3.05)	130 130 130	— — —	— — —	13 94V-0 23 94V-0 47 94V-0	200 + 200 + 200 +	0.2 0.3 0.2	— — 127	— — 800 +

Reports. August 14, 1981; June 11, 1973; August 14, 1981; April 15, 1975.

Replaces E41797B1A dated January 20, 1984.  
 714089011 N0088 Underwriters Laboratories Inc.\*

(Cont. on B2 card)  
 D11/0047755





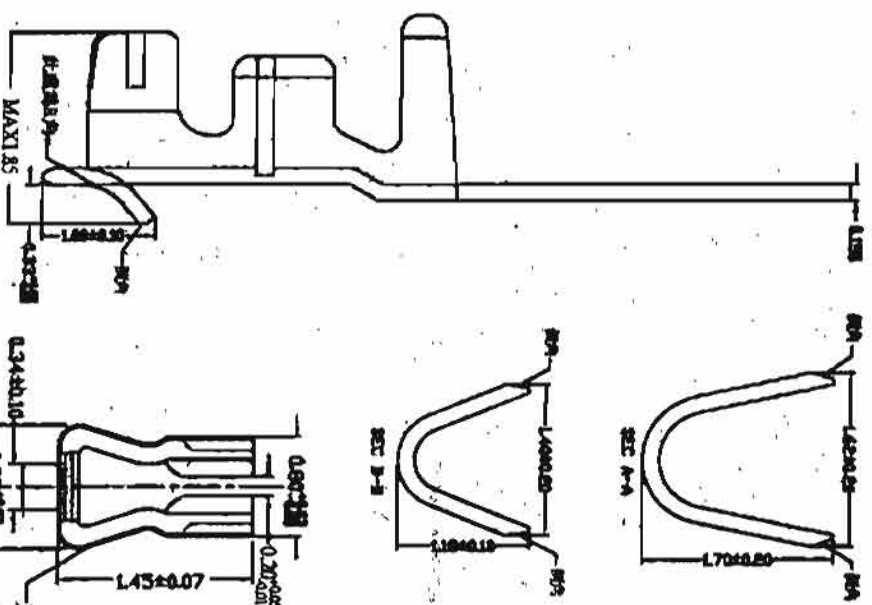
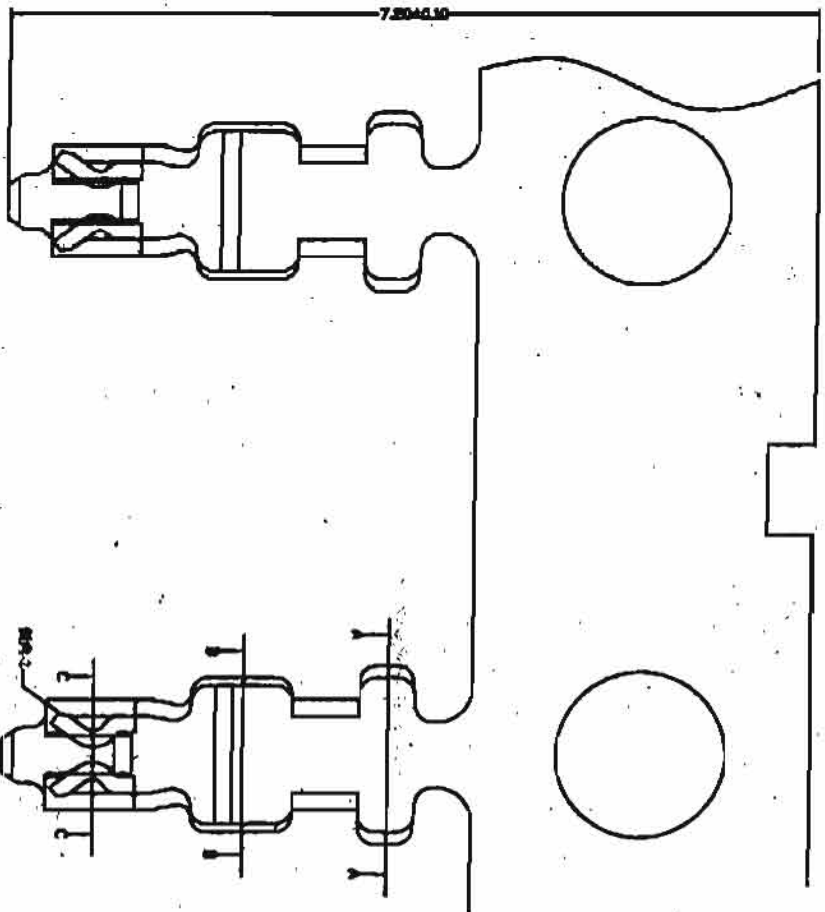

固持力MIN1.0Kg

號：020105  
 模 名：DF13  
 品 號：A1252-T  
 料 材 料 規 格：33-015-086EH-00-10  
 電鍍方式：先沖后鍍，打鍍底40-60u"  
 整支端子鍍純錫80-120u"

REVISION	DATE	DESCRIPTION	MATERIAL	DRAWN BY	CHECKED BY	DESIGNED BY	SCALE	DATE	GENERAL TOLERANCE
I	85/12/79	SHAW-WORTH 29		LTU		LTU	24/1		
G	97/04/09	SHAW-WORTH 29							
H	98/03/06	SHAW-WORTH 29							

XS 鑫盛电子有限公司



DRAWING NO.	020105
DATE	08/01/2008



Test Report

No.: GZ0709131728/CHEM

Date: SEP 12, 2007

Page 1 of 4

TONG BAO METAL & PLATING FACTORY
WORKSHOP 16, LICHENG INDUSTRIAL PARK, NIUQUNPU INDUSTRIAL ZONE, CHANGSHOU ROAD, JIUTAN,
YUANZHOU TOWN, HUIZHOU CITY, GUANGDONG PROVINCE

The following sample(s) was/were submitted and identified on behalf of the applicant as Sn/Ni/Cu-P

SGS Ref No. : SZ10555685-4.2
Sample Receiving Date : SEP 06, 2007
Testing Period : SEP 06, 2007 TO SEP 12, 2007

Test Requested : In accordance with the RoHS Directive 2002/95/EC, and its amendment directives.

Test Method : With reference to IEC 62321 Ed.1 111/54/CDV
Procedures for the Determination of Levels of Regulated Substances in Electrotechnical Products
(1) Determination of Cadmium by ICP.
(2) Determination of Lead by ICP.
(3) Determination of Mercury by ICP.
(4) Determination of Hexavalent Chromium by Colorimetric Method.

Test Results : Please refer to next page.

Conclusion : Based on the performed tests on submitted sample(s), the results comply with the RoHS
Directive 2002/95/EC and its subsequent amendments.

Signed for and on behalf of
SGS-CSTC Ltd.



Huang-Fan, Sunny
Sr. Engineer



This Test Report is issued by the Company subject to its General Conditions of Service printed overleaf or available on request and accessible
at www.sgs.com. Attention is drawn to the limitations of liability, indemnification and jurisdictional issues defined therein. Unless otherwise stated
the results shown in this test report refer only to the sample(s) tested. This test report cannot be reproduced, except in full, without prior written
permission of the Company. Any unauthorized alteration, forgery or falsification of the content or appearance of this report is unlawful and
readers may be prosecuted to the fullest extent of the law.

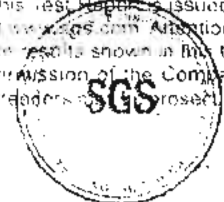

Address: 80801663, 80801663, 80801663, 80801663, 80801663, 80801663, 80801663, 80801663, 80801663, 80801663
(86-20) 82155555 (86-20) 82075125 www.cn.sgs.com
(86-20) 82155555 (86-20) 82075125 e: sgs.cn@mail.sgs.com



Test Report

No. GZ0709131728/CHEM

Date: SEP 12, 2007

Page 2 of 4

Test results by chemical method (Unit: mg/kg)

Test Item(s):	Method (refer to)	No.1	MDL	RoHS Limit
Cadmium(Cd)	(1)	N.D.	2	100
Lead (Pb)	(2)	20	2	1000
Mercury (Hg)	(3)	N.D.	2	1000
Hexavalent Chromium (CrVI) by boiling water extraction	(4)	Negative	See Note 4	#

Test Part Description:

No.1 Silvery plated metal

Note : 1. mg/kg = ppm

2. N.D. = Not Detected (< MDL)

3. MDL = Method Detection Limit

4. Spot-test:

Negative = Absence of CrVI coating, Positive = Presence of CrVI coating;

(The tested sample should be further verified by boiling-water-extraction method if the spot test result cannot be confirmed.)

Boiling-water-extraction:

Negative = Absence of CrVI coating

Positive = Presence of CrVI coating; the detected concentration in boiling-water-extraction solution is equal or greater than 0.02 mg/kg with 50 cm<sup>2</sup> sample surface area.

5. # = Positive indicates the presence of CrVI on the tested areas and result be regarded as conflict with RoHS requirement.

Negative indicates the absence of CrVI on the tested areas and result be regarded as no conflict with RoHS requirement.



This Test Report is issued by the Company subject to its General Conditions of Service printed overleaf or available on request and accessible at www.sgs.com. Attention is drawn to the limitations of liability, indemnification and jurisdictional issues defined therein. Unless otherwise stated the results shown in this Test Report refer only to the sample(s) tested. This test report cannot be reproduced, except in full, without prior written permission of the Company. Any unauthorized alteration, forgery or falsification of the content or appearance of this report is unlawful and offenders may be prosecuted to the fullest extent of the law.

ATTACHMENTS

Testing Flow Chart

- 1) Name of the person who made measurement: David Shen
- 2) Name of the person in charge of measurement: Emily Feng

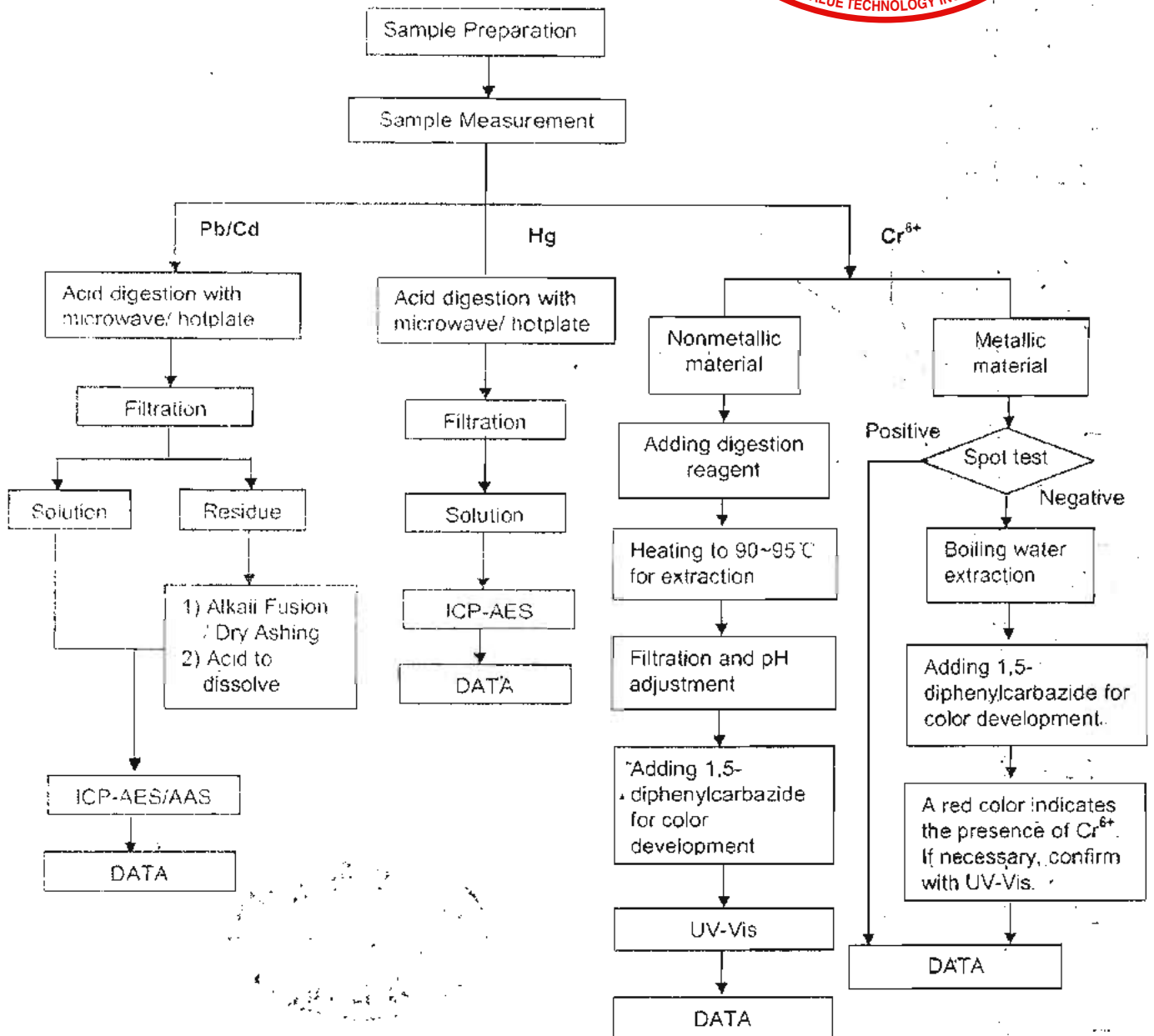

This Test Report is issued by the Company subject to its General Conditions of Service printed overleaf or available on request and accessible at [www.sgs.com](http://www.sgs.com). Attention is drawn to the limitations of ability, indemnification and jurisdictional issues defined therein. Unless otherwise stated the results shown in this test report refer only to the samples tested. This test report cannot be reproduced, except in full, without prior written permission of the Company. Any unauthorized alteration, forgery or falsification of the content or appearance of this report is unlawful and offenders will be prosecuted to the fullest extent of the law.

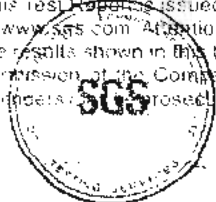

Sample photo:

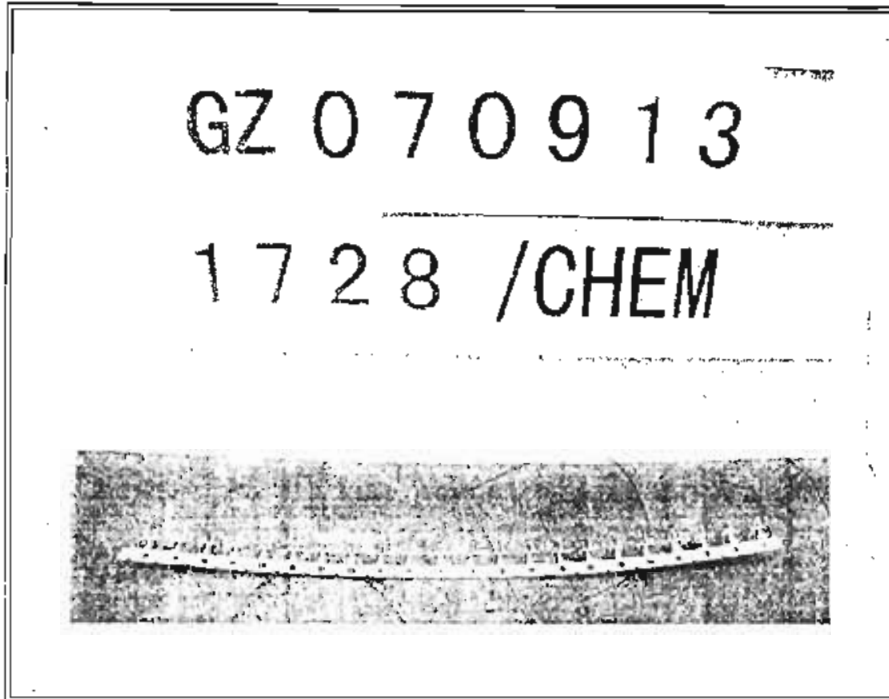

SGS authenticate the photo on original report only

\*\*\* End of Report \*\*\*



This Test Report is issued by the Company subject to its General Conditions of Service printed overleaf or available on request and accessible at [www.sgs.com](http://www.sgs.com). Attention is drawn to the limitations of liability, indemnification and jurisdictional issues defined therein. Unless otherwise stated the results shown in this test report refer only to the sample(s) tested. This test report cannot be reproduced, except in full, without prior written permission of the Company. Any unauthorized alteration, forgery or falsification of the content or appearance of this report is unlawful and offenders will be prosecuted to the fullest extent of the law.

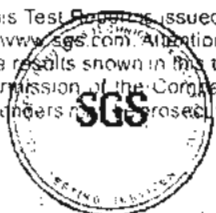

## 測試報告 Test Report

號碼(No.): CE/2007/95061 日期(Date): 2007/10/02 頁數(Page): 1 of 6

新泰伸科技股份有限公司  
HTS TECHNOLOGY CO., LTD.  
326 桃園縣楊梅鎮民隆路8號  
8, MING LUNG RD., YANG MEI JEN, TAO YUAN, TAIWAN 326, R. O. C.



以下測試樣品係由客戶送樣，且由客戶聲稱並經客戶確認如下 (The following samples was/were submitted and identified by/on behalf of the client as):

樣品名稱(Sample Description) : 磷青銅 (PHOSPHOR BRONZE)  
收件日期(Sample Receiving Date) : 2007/09/26  
測試期間(Testing Period) : 2007/09/26 TO 2007/10/02

- =====  
**測試需求 (Test Requested)** : 參照 RoHS 2002/95/EC 及其修定指令要求。 (In accordance with the RoHS Directive 2002/95/EC, and its amendment directives).
- 測試方法 (Test Method)** : 參考 IEC 62321, Ed. 1 111/54/CDV 方法檢測。 (With reference to IEC 62321, Ed.1 111/54/CDV. Procedures for the Determination of Levels of Regulated Substances in Electrotechnical Products).
- (1) 用感應耦合電漿原子發射光譜儀檢測鎘含量。 / Determination of Cadmium by ICP-AES.
  - (2) 用感應耦合電漿原子發射光譜儀檢測鉛含量。 / Determination of Lead by ICP-AES.
  - (3) 用感應耦合電漿原子發射光譜儀檢測汞含量。 / Determination of Mercury by ICP-AES.
  - (4) 針對金屬材質之樣品，用 Spot test / Colorimetric 方法檢測六價鉻含量。 / Determination of Hexavalent Chromium for metallic samples by Spot test / Colorimetric Method.
  - (5) 以氣相層析儀/質譜儀檢測多溴聯苯和多溴聯苯醚含量。 / Determination of PBB and PBDE by GC/MS.
- 測試結果 (Test Results)** : 請見下一頁 (Please refer to next pages).
- 結論 (Conclusion)** : 根據客戶所提供樣品的測試結果，符合 RoHS (2002/95/EC) 及其修定指令之要求 (Based on the performed tests on submitted samples, the test results are **compliant with** the limits of RoHS Directive 2002/95/EC and its subsequent amendments).

  
Chenyu Kung / Operation Manager  
Signed for and on behalf of  
SGS TAIWAN LTD.  
Chemical Laboratory – Taipei



# 測試報告 Test Report

號碼(No.): CE/2007/95061

日期(Date): 2007/10/02

頁數(Page): 2 of 6

新泰伸科技股份有限公司  
HTS TECHNOLOGY CO., LTD.  
326 桃園縣楊梅鎮民隆路8號  
8, MING LUNG RD., YANG MEI JEN, TAO YUAN, TAIWAN 326, R. O. C.



測試結果(Test Results) 單位(Unit): mg/kg

測試項目 (Test Items)	測試方法 Method (Refer to)	結果 (Result)	方法偵測 極限值 (MDL)	RoHS 限值 (Limit)
		No.1		
鎘 / Cadmium (Cd)	(1)	n.d.	2	100
鉛 / Lead (Pb)	(2)	22	2	1000
汞 / Mercury (Hg)	(3)	n.d.	2	1000
六價鉻 / Hexavalent Chromium Cr(VI) by Spot test / boiling water extraction	(4)	Negative	See Note 5	#
<b>多溴聯苯總和 / Sum of PBBs</b>		n.d.	-	1000
一溴聯苯 / Monobromobiphenyl		n.d.	5	-
二溴聯苯 / Dibromobiphenyl		n.d.	5	-
三溴聯苯 / Tribromobiphenyl		n.d.	5	-
四溴聯苯 / Tetrabromobiphenyl		n.d.	5	-
五溴聯苯 / Pentabromobiphenyl		n.d.	5	-
六溴聯苯 / Hexabromobiphenyl		n.d.	5	-
七溴聯苯 / Heptabromobiphenyl		n.d.	5	-
八溴聯苯 / Octabromobiphenyl		n.d.	5	-
九溴聯苯 / Nonabromobiphenyl		n.d.	5	-
十溴聯苯 / Decabromobiphenyl		n.d.	5	-
<b>多溴聯苯醚總和 (一至九溴) / Sum of PBDEs (Mono to Nona) (Note 4)</b>	(5)	n.d.	-	1000
一溴聯苯醚 / Monobromobiphenyl ether		n.d.	5	-
二溴聯苯醚 / Dibromobiphenyl ether		n.d.	5	-
三溴聯苯醚 / Tribromobiphenyl ether		n.d.	5	-
四溴聯苯醚 / Tetrabromobiphenyl ether		n.d.	5	-
五溴聯苯醚 / Pentabromobiphenyl ether		n.d.	5	-
六溴聯苯醚 / Hexabromobiphenyl ether		n.d.	5	-
七溴聯苯醚 / Heptabromobiphenyl ether		n.d.	5	-
八溴聯苯醚 / Octabromobiphenyl ether		n.d.	5	-
九溴聯苯醚 / Nonabromobiphenyl ether		n.d.	5	-
十溴聯苯醚 / Decabromobiphenyl ether		n.d.	5	-
<b>多溴聯苯醚總和 (一至十溴) / Sum of PBDEs (Mono to Deca)</b>		n.d.	-	-



**測試部位描述 (TEST PART DESCRIPTION):**

NO.1 : 金色金屬 (COPPER COLORED METAL)

## 測試報告 Test Report

號碼(No.): CE/2007/95061

日期(Date): 2007/10/02

頁數(Page): 3 of 6

新泰伸科技股份有限公司

HTS TECHNOLOGY CO., LTD.

326 桃園縣楊梅鎮民隆路8號

8, MING LUNG RD., YANG MEI JEN, TAO YUAN, TAIWAN 326, R. O. C.



備註(Note):

1. mg/kg = ppm
2. n.d. = Not Detected (未檢出)
3. MDL = Method Detection Limit (方法偵測極限值)
4. 根據2005年10月13日歐盟會議公佈2005/717/EC, 修訂2002/95/EC內容, 通過解除高分子材質中十溴聯苯醚之使用限制. (According to 2005/717/EC DecaBDE is exempt.)
5. Spot-test:
  - Negative = Absence of Cr(VI) coating / surface layer(鍍層中偵測不到六價鉻),
  - Positive = Presence of Cr(VI) coating / surface layer(鍍層中偵測到六價鉻);
  - The tested sample should be further verified by boiling-water-extraction method if the spot test result cannot be confirmed.
  - (當該測項無法確認時, 測試樣品可藉由boiling-water-extraction測試方法進一步確認)
- Boiling-water-extraction:
  - Negative = Absence of Cr(VI) coating / surface layer(鍍層中偵測不到六價鉻),
  - Positive = Presence of Cr(VI) coating / surface layer(鍍層中偵測到六價鉻);
  - the detected concentration in boiling-water-extraction solution is equal or greater than 0.02 mg/kg with 50 cm<sup>2</sup> sample surface area.
  - 該溶液濃度 $\geq$ 0.02 mg/kg with 50 cm<sup>2</sup> (sample surface area)
6. # = Positive indicates the presence of Cr(VI) on the tested areas and result be regarded as not comply with RoHS requirement. (Positive表示測試區域之六價鉻不符合RoHS要求)  
 Negative indicates the absence of Cr(VI) on the tested areas and result be regarded as comply with RoHS requirement. (Negative表示測試區域之六價鉻符合RoHS要求)
7. "-" = Not Regulated (無規格值)





## 測試報告 Test Report

號碼(No.): CE/2007/95061

日期(Date): 2007/10/02

頁數(Page): 4 of 6

新泰伸科技股份有限公司  
HTS TECHNOLOGY CO., LTD.  
326 桃園縣楊梅鎮民隆路8號  
8, MING LUNG RD., YANG MEI JEN, TAO YUAN, TAIWAN 326, R. O. C.



- 1) 根據以下的流程圖之條件，樣品已完全溶解。(六價鉻測試方法除外) / These samples were dissolved totally by pre-conditioning method according to below flow chart. (Cr<sup>6+</sup> test method excluded)
- 2) 測試人員：張啓興 / Name of the person who made measurement: Troy Chang
- 3) 測試負責人：龔振裕 / Name of the person in charge of measurement: Chenyu Kung

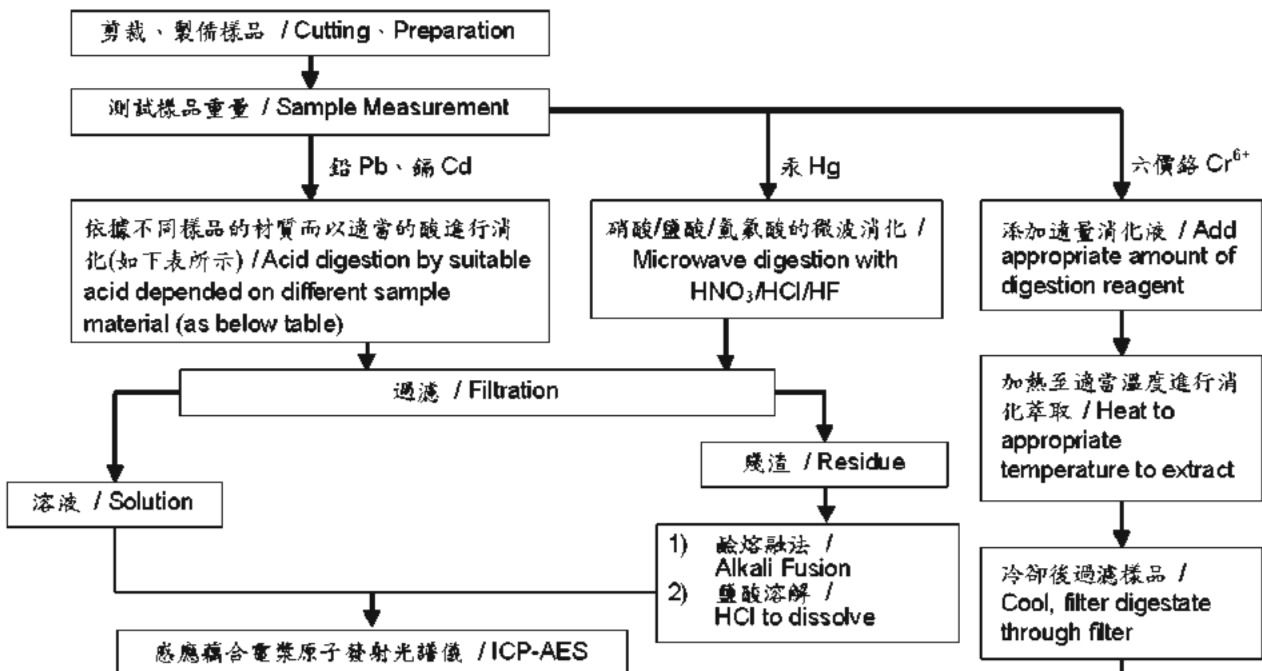

樣品材質 / Sample Material	消化酸液種類 / Digestion Acid
鋼, 銅, 鋁, 焊錫 / Steel, copper, aluminum, solder	王水, 硝酸, 鹽酸, 氫氟酸, 雙氧水 / Aqua regia, HNO <sub>3</sub> , HCl, HF, H <sub>2</sub> O <sub>2</sub>
玻璃 / Glass	硝酸, 氫氟酸 / HNO <sub>3</sub> /HF
金, 鉑, 鈀, 陶瓷 / Gold, platinum, palladium, ceramic	王水 / Aqua regia
銀 / Silver	硝酸 / HNO <sub>3</sub>
塑膠 / Plastic	硫酸, 雙氧水, 硝酸, 鹽酸 / H <sub>2</sub> SO <sub>4</sub> , H <sub>2</sub> O <sub>2</sub> , HNO <sub>3</sub> , HCl
其他 / Others	加入任何酸至完全溶解 / Any acid to total digestion



## 測試報告 Test Report

號碼(No.): CE/2007/95061

日期(Date): 2007/10/02

頁數(Page): 5 of 6

新泰伸科技股份有限公司  
HTS TECHNOLOGY CO., LTD.  
326 桃園縣楊梅鎮民隆路8號  
8, MING LUNG RD., YANG MEI JEN, TAO YUAN, TAIWAN 326, R. O. C.



### 多溴聯苯/多溴聯苯醚分析流程圖 / PBB/PBDE analytical FLOW CHART

初次測試程序 / First testing process ———>

選擇性篩檢程序 / Optional screen process .....>

確認程序 / Confirmation process - - - ->

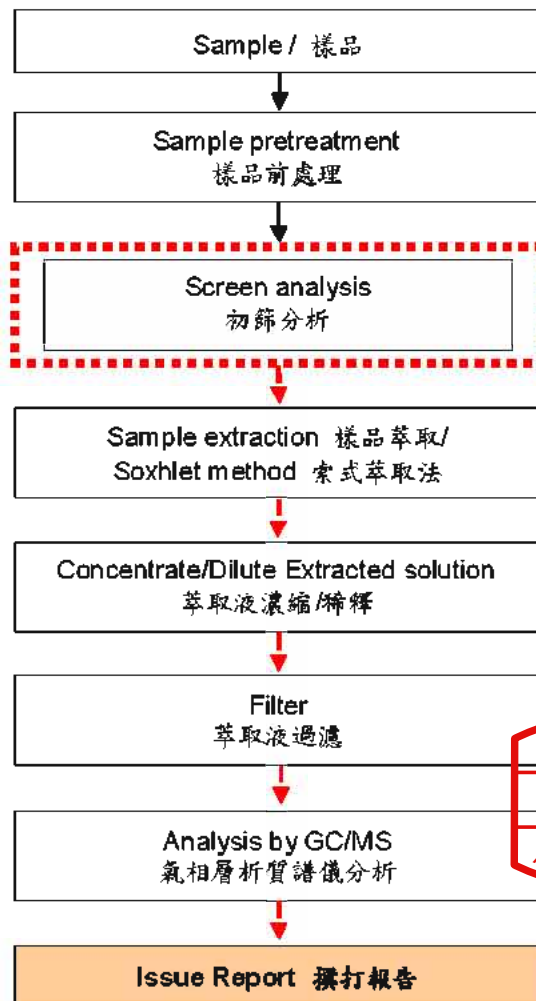

## 測試報告 Test Report

號碼(No.): CE/2007/95061

日期(Date): 2007/10/02

頁數(Page): 6 of 6

新泰伸科技股份有限公司  
HTS TECHNOLOGY CO., LTD.  
326 桃園縣楊梅鎮民隆路8號  
8, MING LUNG RD., YANG MEI JEN, TAO YUAN, TAIWAN 326, R. O. C.



\*\* 報告結尾 \*\*





JOINT TECH ELECTRONIC  
INDUSTRIAL CO LTD  
MR T TUNG  
1ST FL  
50 TA AN ST  
HSI-CHIH CHEN  
TAIPEI HSIEN TAIWAN

Your most recent Certification is shown below. You may also view this information, or a portion of this information (depending on the product category), on UL's Online Certifications Directory at [www.ul.com/database](http://www.ul.com/database). Please review the text and contact the Conformity Assessment Services staff member who handled your project if revisions are required. For instructions on placing an order for this information in a 3 x 5-inch format, you may refer to the enclosed order form for UL-Card Service.

ECBT2 August 13, 2008  
Connectors for Use in Data, Signal, Control and Power Applications - Component

JOINT TECH ELECTRONIC INDUSTRIAL CO LTD  
1ST FL 50 TA AN ST HSI-CHIH CHEN, TAIPEI HSIEN TAIWAN

E179967

Connectors, Cat. No. A1080 followed by H or WV, followed by 1P thru 6P; Cat. No. A1250 followed by H, WR, WR-S, WV or WV-S, followed by 2P thru 15P; Cat. No. A1251 followed by H, WR or WV, followed by 2P thru 15P; Cat. No. A1252 followed by H, WR, WR-S, WV or WV-S, followed by 2P thru 15P; Cat. No. A1500 followed by H, WR or WV, followed by 2P thru 15P; Cat. No. A2013 followed by H, F or WV, followed by 3P; Cat. No. A2211 followed by H, WV-S, followed by 4P thru 60P; Cat. No. A2540 followed by H, WR or WV, followed by 2P thru 12P; Cat. No. A4000 followed by H or WR-S, followed by 2P thru 4P; Cat. No. C4288 followed by HF-2, HM-2, WR-2, WR-S-2, WV-2 or WVA-2 or WVA-P-2, followed by 2P thru 24P; Cat. No. C5082 followed by HF, HL, HM or WV, followed by 4P; Cat. No. A7500 followed by H or WV, followed by 1P thru 6P.

Connectors, Cat. No. A2001 followed by H, WR or WV, followed by 2P thru 16P; Cat. No. B0011 followed by HV or HR, followed by 2P thru 16P; Cat. No. A2100 followed by H, WR or WV, followed by 2P thru 15P; Cat. No. A2501 followed by H, WR or WV, followed by 2P thru 15P; Cat. No. A2502 followed by H, WR or WV, followed by 2P thru 15P; Cat. No. A2503 followed by H, WR or WV, followed by 2P thru 20P; Cat. No. C2505 followed by HM or HE, followed by 2P thru 18P; Cat. No. A2541 followed by H-M, WR or WV, followed by 4P; Cat. No. A2542 followed by H, WR or WV, followed by 2P thru 20P; Cat. No. A2960 followed by H, WR or WV, followed by 2P thru 20P; Cat. No. A3961 followed by H, WR or WV, followed by 2P thru 15P; Cat. No. B2512 followed by H, followed by 2P thru 16P.

Connectors, Cat. No. A12521S-2X, A12521WV-S-2X, A12521WVA-S-2X followed by 5P, 10P, 15P or 20P; Cat. No. A12531S, A12531WV-S followed by 2P thru 10P, 15P, 20P, 25P or 30P; Cat. No. A1254H, A1254WR-S followed by 2P, 3P, 5P, 6P, 7P, 9P, 14P, 15P, 20P or 30P; Cat. No. A2004H, A2004WV, A2004WR followed by 2X, followed by 2P thru 20P; Cat. No. A29621 followed by 3P thru 12P; Cat. No. B2513HV, B2513HR followed by 2P thru 16P; Cat. No. C6501HP followed by 6P, followed by 1 or 2; Cat. No. C6501HM followed by 16P.

Converter series, Cat. No. A2502.  
Low voltage connectors, Cat. No. A2500 followed by H, WR or WV, followed by 2P thru 15P; Cat. No. A2506 followed by H, WR or WV, followed by 2P thru 15P; Cat. No. A2015 followed by WR or WV, followed by 2P thru 40P; Cat. No. A2016 followed by WR or WV, followed by 4P thru 80P; Cat. No. A2545 followed by WR, WV, followed by 2P thru 40P; Cat. No. A2546 followed by WR or WV, followed by 4P thru 80P; Cat. No. A2547 followed by WR or WV, followed by 6P thru 120P; Cat. No. C3030 followed by HF-2 or HM-2, followed by 3P thru 24P; Cat. No. A350WR-S-2P.

Ribbon cable connectors, Series A2001, A1501, B2512.

Marking: Company name or trademarks "UL", "CLP" and catalog or series designation on device or carton.

See General Information Preceding These Recognitions

For use only in equipment where the acceptability of the combination is determined by Underwriters Laboratories Inc.



An independent organization working for a safer world with integrity, precision and knowledge

925299001



2007.12.1 11:22 P. 1

FAX NO. : 00789712897

FROM : 209 444



# UL 1571 HOOK-UP WIRE

## 80°C 30V PVC 電子線

### SPECIFICATION

STYLE		UL 1571								CSA
RATING TEMP / VOLT		80°C/30V								
CONDUCTOR	SIZE		AWG	30	28					
	NUMBER		NO.	7	7					
	DIAMETER		MM	0.100	0.127					
	MIN.DIAMETER		MM	0.093	0.120					
	CROSS SEC AREA OF COND	AVG.	CM	100	150					
		MIN		98	156					
	LAY OF BUNCH		INCH	0.40	0.50					
MAX.RESISTANCE		Ω/KM	397	248						
INSULATION	O.D.(±0.05)		MM	0.55	0.60					
	INSULATION THICKNESS	AVG	MIL	8						
		MIN								6
JACKET THICKNESS	AVG	MIL								
	MI									
ADHESIVE TEST		KG								
INSULATION RESISTANCE		MΩ/KM	15							
SPARK TEST		KV	2							
ELONGATION		%	100							
TENSIL STRENGTH		PSI	1500							
ELO.(AFTER AGING)		%	OF UNAGED	65						
TEN.ST.(AFTER AGING)		%	OF UNAGED	70						
AGING TEMP TIME		113°C/168HRS								
OIL LMMERSION TEST										
FIAME TEST		VW-1								
HEAT SHOCK TEST		121°C/1HR		1.60MM MANDREL						
DEFORMATION TEST		113°C/1HR		50%						
COLD BEND TEST		-10°C/1HR		0.4MM MANDREL						
INSULATION POTENTIALST		500VAC/MIN								
印字内容: (无)										



## Test Report

No. SH7136502/CHEM

Date: Nov. 14, 2007

Page 1 of 3

KAITAT INDUSTRIES CO  
CHANGZHEN GONGMING TOWN SHENZHEN CITY

The following sample(s) was/were submitted and identified by/on behalf of the client as:

Sample Name : WIRE (BROWN)  
SGS Ref No. : SZ10683921-9.6  
Sample Information : 1007, 1015, 1061, 1571, 20276, 1095, 2468, 1617, 1672, 彩排线, 油墨及印字

Sample Receiving Date : Nov.12, 2007  
Testing Period : Nov.12 - 14, 2007

Test Requested : In accordance with the RoHS Directive 2002/95/EC, and its amendment directives.

Test Method : (1) With reference to IEC 62321 Ed.1 111/54/CDV for Cadmium content.  
Analysis was performed by ICP.  
(2) With reference to IEC 62321 Ed.1 111/54/CDV for Lead content.  
Analysis was performed by ICP.  
(3) With reference to IEC 62321 Ed.1 111/54/CDV for Mercury content.  
Analysis was performed by ICP.  
(4) With reference to IEC 62321 Ed.1 111/54/CDV for Hexavalent Chromium by  
Colorimetric Method.  
(5) With reference to IEC 62321 Ed.1 111/54/CDV for PBBs / PBDEs content.  
Analysis was performed by GC/MS.

Test Results : Please refer to next pages

Signed for and on behalf of  
SGS-CSTC Chemical Laboratory



Ella Zhang  
Section Manager

Signed for and on behalf of  
SGS-CSTC Chemical Laboratory



Sandy Hao  
Lab Manager



Test results by chemical method (Unit: mg/kg)

Test Item(s):	Method (refer to)	1	MDL	RoHS Limit
Cadmium(Cd)	(1)	ND	2	100
Lead (Pb)	(2)	ND	2	1000
Mercury (Hg)	(3)	ND	2	1000
Hexavalent Chromium (CrVI) by alkaline extraction	(4)	ND	2	1000
Sum of PBBs		ND	-	1000
Monobromobiphenyl		ND	5	-
Dibromobiphenyl		ND	5	-
Tribromobiphenyl		ND	5	-
Tetrabromobiphenyl		ND	5	-
Pentabromobiphenyl		ND	5	-
Hexabromobiphenyl		ND	5	-
Heptabromobiphenyl		ND	5	-
Octabromobiphenyl		ND	5	-
Nonabromobiphenyl		ND	5	-
Decabromobiphenyl		ND	5	-
Sum of PBDEs (Note 4)	(5)	ND	-	1000
Monobromodiphenyl ether		ND	5	-
Dibromodiphenyl ether		ND	5	-
Tribromodiphenyl ether		ND	5	-
Tetrabromodiphenyl ether		ND	5	-
Pentabromodiphenyl ether		ND	5	-
Hexabromodiphenyl ether		ND	5	-
Heptabromodiphenyl ether		ND	5	-
Octabromodiphenyl ether		ND	5	-
Nonabromodiphenyl ether		ND	5	-
Decabromodiphenyl ether		ND	5	-
Sum of PBDEs (Mono to Deca)		ND	-	-

### Test Part Description:

1. Brown plastic wire with white printing

### Note:

- (1) mg/kg = ppm
- (2) ND = Not Detected
- (3) MDL = Method Detection Limit
- (4) Sum of Mono to NonaBDE & according to 2005/717/EC DecaBDE is exempt.
- (5) "-" = Not Regulated
- (6) The maximum permissible limit is quoted from the document 2005/618/EC amending RoHS directive 2002/95/EC



Sample photo:



SGS authenticate the photo on original report only

\*\*\* End of Report \*\*\*







## Test Report

No.: GZ0711168244/CHEM

Date: NOV 14, 2007

Page 1 of 3

KAI TAT INDUSTRIES CO  
CHANG ZHEN GONG MING TOWN SHEN ZHEN CITY

The following sample(s) was/were submitted and identified on behalf of the applicant as WIRE  
Client Reference: 1007, 1015, 1061, 1571, 20276, 1095, 2468, 1617, 1672, 彩排线

SGS Ref No. : SZ10683920-3.1  
Sample Receiving Date : NOV 09, 2007  
Testing Period : NOV 09, 2007 TO NOV 14, 2007

Test Requested : In accordance with the RoHS Directive 2002/95/EC, and its amendment directives.

Test Method : With reference to IEC 62321 Ed.1 111/54/CDV  
Procedures for the Determination of Levels of Regulated Substances in Electrotechnical Products  
(1) Determination of Cadmium by ICP.  
(2) Determination of Lead by ICP.  
(3) Determination of Mercury by ICP.  
(4) Determination of Hexavalent Chromium by Colorimetric Method.  
(5) Determination of PBBs and PBDEs by GC-MS.

Test Results : Please refer to next page.

Conclusion : Based on the performed tests on submitted sample(s), the results comply with the RoHS  
Directive 2002/95/EC and its subsequent amendments.

Signed for and on behalf of  
SGS-CSTC Ltd.



  
Jiang YongPing, Terry  
Sr. Engineer

**Test results by chemical method (Unit: mg/kg)**

Test Item(s):	Method (refer to)	No.1	MDL	RoHS Limit
Cadmium(Cd)	(1)	N.D.	2	100
Lead (Pb)	(2)	N.D.	2	1000
Mercury (Hg)	(3)	N.D.	2	1000
Hexavalent Chromium (CrVI) by alkaline extraction	(4)	N.D.	2	1000
<b>Sum of PBBs</b>		N.D.	-	1000
Monobromobiphenyl		N.D.	5	
Dibromobiphenyl		N.D.	5	
Tribromobiphenyl		N.D.	5	
Tetrabromobiphenyl		N.D.	5	
Pentabromobiphenyl		N.D.	5	
Hexabromobiphenyl		N.D.	5	
Heptabromobiphenyl		N.D.	5	
Octabromobiphenyl		N.D.	5	
Nonabromobiphenyl		N.D.	5	
Decabromobiphenyl		N.D.	5	
<b>Sum of PBDEs (Mono to Nona)(Note 4)</b>	(5)	N.D.	-	1000
Monobromodiphenyl ether		N.D.	5	
Dibromodiphenyl ether		N.D.	5	
Tribromodiphenyl ether		N.D.	5	
Tetrabromodiphenyl ether		N.D.	5	
Pentabromodiphenyl ether		N.D.	5	
Hexabromodiphenyl ether		N.D.	5	
Heptabromodiphenyl ether		N.D.	5	
Octabromodiphenyl ether		N.D.	5	
Nonabromodiphenyl ether		N.D.	5	
Decabromodiphenyl ether		N.D.	5	
<b>Sum of PBDEs (Mono to Deca)</b>		N.D.	-	-

**Test Part Description:**

No. 1 Black plastic (jacket)

**Note :** 1. mg/kg = ppm

2. N.D. = Not Detected (&lt; MDL)

3. MDL = Method Detection Limit

4. Sum of Mono to NonaBDE &amp; according to 2005/717/EC DecaBDE is exempt.

5. "-" = Not regulated



Sample photo :



SGS authenticate the photo on original report only

\*\*\* End of Report \*\*\*



## Test Report

No. SH7136503/CHEM

Date: Nov. 14, 2007

Page 1 of 3

KAITAT INDUSTRIES CO  
CHANGZHEN GONGMING TOWN SHENZHEN CITY

The following sample(s) was/were submitted and identified by/on behalf of the client as:

Sample Name : WIRE YELLOW  
SGS Ref No. : SZ10683921-9.7  
Sample Information : 1007, 1015, 1061, 1571, 20276, 1095, 2468, 1617, 1672, 彩排线, 油墨及印字

Sample Receiving Date : Nov.12, 2007  
Testing Period : Nov.12 - 14, 2007

Test Requested : In accordance with the RoHS Directive 2002/95/EC, and its amendment directives.

Test Method : (1) With reference to IEC 62321 Ed.1 111/54/CDV for Cadmium content.  
Analysis was performed by ICP.  
(2) With reference to IEC 62321 Ed.1 111/54/CDV for Lead content.  
Analysis was performed by ICP.  
(3) With reference to IEC 62321 Ed.1 111/54/CDV for Mercury content.  
Analysis was performed by ICP.  
(4) With reference to IEC 62321 Ed.1 111/54/CDV for Hexavalent Chromium by  
Colorimetric Method.  
(5) With reference to IEC 62321 Ed.1 111/54/CDV for PBBs / PBDEs content.  
Analysis was performed by GC/MS.

Test Results : Please refer to next pages

Signed for and on behalf of  
SGS-CSTC Chemical Laboratory



Ella Zhang  
Section Manager

Signed for and on behalf of  
SGS-CSTC Chemical Laboratory



Sandy Hao  
Lab Manager



Test results by chemical method (Unit: mg/kg)

Test Item(s):	Method (refer to)	1	MDL	RoHS Limit
Cadmium(Cd)	(1)	ND	2	100
Lead (Pb)	(2)	ND	2	1000
Mercury (Hg)	(3)	ND	2	1000
Hexavalent Chromium (CrVI) by alkaline extraction	(4)	ND	2	1000
Sum of PBBs		ND	-	1000
Monobromobiphenyl		ND	5	-
Dibromobiphenyl		ND	5	-
Tribromobiphenyl		ND	5	-
Tetrabromobiphenyl		ND	5	-
Pentabromobiphenyl		ND	5	-
Hexabromobiphenyl		ND	5	-
Heptabromobiphenyl		ND	5	-
Octabromobiphenyl		ND	5	-
Nonabromobiphenyl		ND	5	-
Decabromobiphenyl		ND	5	-
Sum of PBDEs (Note 4)	(5)	ND	-	1000
Monobromodiphenyl ether		ND	5	-
Dibromodiphenyl ether		ND	5	-
Tribromodiphenyl ether		ND	5	-
Tetrabromodiphenyl ether		ND	5	-
Pentabromodiphenyl ether		ND	5	-
Hexabromodiphenyl ether		ND	5	-
Heptabromodiphenyl ether		ND	5	-
Octabromodiphenyl ether		ND	5	-
Nonabromodiphenyl ether		ND	5	-
Decabromodiphenyl ether		ND	5	-
Sum of PBDEs (Mono to Deca)		ND	-	-



**Test Part Description:**

1. Yellow plastic wire with black printing

**Note:**

- (1) mg/kg = ppm
- (2) ND = Not Detected
- (3) MDL = Method Detection Limit
- (4) Sum of Mono to NonaBDE & according to 2005/717/EC DecaBDE is exempt.
- (5) "-" = Not Regulated
- (6) The maximum permissible limit is quoted from the document 2005/618/EC amending RoHS directive 2002/95/EC

Sample photo:



SGS authenticate the photo on original report only

\*\*\* End of Report \*\*\*



## Test Report

No. SH7136497/CHEM

Date: Nov. 14, 2007

Page 1 of 3

KAITAT INDUSTRIES CO  
CHANGZHEN GONGMING TOWN SHENZHEN CITY

The following sample(s) was/were submitted and identified by/on behalf of the client as:

Sample Name : WIRE WHITE  
SGS Ref No. : SZ10683921-9.1  
Sample Information : 1007, 1015, 1061, 1571, 20276, 1095, 2468, 1617, 1672, 彩排线, 油墨及印章

Sample Receiving Date : Nov.12, 2007  
Testing Period : Nov.12 - 14, 2007

Test Requested : In accordance with the RoHS Directive 2002/95/EC, and its amendment directives.

Test Method : (1) With reference to IEC 62321 Ed.1 111/54/CDV for Cadmium content.  
Analysis was performed by ICP.  
(2) With reference to IEC 62321 Ed.1 111/54/CDV for Lead content.  
Analysis was performed by ICP.  
(3) With reference to IEC 62321 Ed.1 111/54/CDV for Mercury content.  
Analysis was performed by ICP.  
(4) With reference to IEC 62321 Ed.1 111/54/CDV for Hexavalent Chromium by  
Colorimetric Method.  
(5) With reference to IEC 62321 Ed.1 111/54/CDV for PBBs / PBDEs content.  
Analysis was performed by GC/MS.

Test Results : Please refer to next pages

Signed for and on behalf of  
SGS-CSTC Chemical Laboratory



Ella Zhang  
Section Manager

Signed for and on behalf of  
SGS-CSTC Chemical Laboratory



Sandy Hao  
Lab Manager



Test results by chemical method (Unit: mg/kg)

Test Item(s):	Method (refer to)	1	MDL	RoHS Limit
Cadmium(Cd)	(1)	ND	2	100
Lead (Pb)	(2)	ND	2	1000
Mercury (Hg)	(3)	ND	2	1000
Hexavalent Chromium (CrVI) by alkaline extraction	(4)	ND	2	1000
Sum of PBBs		ND	-	1000
Monobromobiphenyl		ND	5	-
Dibromobiphenyl		ND	5	-
Tribromobiphenyl		ND	5	-
Tetrabromobiphenyl		ND	5	-
Pentabromobiphenyl		ND	5	-
Hexabromobiphenyl		ND	5	-
Heptabromobiphenyl		ND	5	-
Octabromobiphenyl		ND	5	-
Nonabromobiphenyl		ND	5	-
Decabromobiphenyl		ND	5	-
Sum of PBDEs (Note 4)	(5)	ND	-	1000
Monobromodiphenyl ether		ND	5	-
Dibromodiphenyl ether		ND	5	-
Tribromodiphenyl ether		ND	5	-
Tetrabromodiphenyl ether		ND	5	-
Pentabromodiphenyl ether		ND	5	-
Hexabromodiphenyl ether		ND	5	-
Heptabromodiphenyl ether		ND	5	-
Octabromodiphenyl ether		ND	5	-
Nonabromodiphenyl ether		ND	5	-
Decabromodiphenyl ether		ND	5	-
Sum of PBDEs (Mono to Deca)		ND	-	-

**Test Part Description:**

- White plastic wire with black printing

**Note:**

- mg/kg = ppm
- ND = Not Detected
- MDL = Method Detection Limit
- Sum of Mono to NonaBDE & according to 2005/717/EC DecaBDE is exempt
- "-" = Not Regulated
- The maximum permissible limit is quoted from the document 2002/95/EC directive 2002/95/EC





Sample photo



SGS authenticate the photo on original report only

\*\*\* End of Report \*\*\*



## Test Report

No. SH7136504/CHEM

Date: Nov. 14, 2007

Page 1 of 3

KAITAT INDUSTRIES CO  
CHANGZHEN GONGMING TOWN SHENZHEN CITY

The following sample(s) was/were submitted and identified by/on behalf of the client as:

Sample Name : WIRE RED  
SGS Ref No. : SZ10683921-9.8  
Sample Information : 1007, 1015, 1061, 1571, 20276, 1095, 2468, 1617, 1672, 彩排线, 油墨及印字

Sample Receiving Date : Nov.12, 2007  
Testing Period : Nov.12 - 14, 2007

Test Requested : In accordance with the RoHS Directive 2002/95/EC, and its amendment directives.

Test Method : (1) With reference to IEC 62321 Ed.1 111/54/CDV for Cadmium content.  
Analysis was performed by ICP.  
(2) With reference to IEC 62321 Ed.1 111/54/CDV for Lead content.  
Analysis was performed by ICP.  
(3) With reference to IEC 62321 Ed.1 111/54/CDV for Mercury content.  
Analysis was performed by ICP.  
(4) With reference to IEC 62321 Ed.1 111/54/CDV for Hexavalent Chromium by  
Colorimetric Method.  
(5) With reference to IEC 62321 Ed.1 111/54/CDV for PBBs / PBDEs content.  
Analysis was performed by GC/MS.

Test Results : Please refer to next pages

Signed for and on behalf of  
SGS-CSTC Chemical Laboratory



Ella Zhang  
Section Manager

Signed for and on behalf of  
SGS-CSTC Chemical Laboratory



Sandy Hao  
Lab Manager



Test results by chemical method (Unit: mg/kg)

Test Item(s):	Method (refer to)	1	MDL	RoHS Limit
Cadmium(Cd)	(1)	ND	2	100
Lead (Pb)	(2)	ND	2	1000
Mercury (Hg)	(3)	ND	2	1000
Hexavalent Chromium (CrVI) by alkaline extraction	(4)	ND	2	1000
Sum of PBBs		ND	-	1000
Monobromobiphenyl		ND	5	-
Dibromobiphenyl		ND	5	-
Tribromobiphenyl		ND	5	-
Tetrabromobiphenyl		ND	5	-
Pentabromobiphenyl		ND	5	-
Hexabromobiphenyl		ND	5	-
Heptabromobiphenyl		ND	5	-
Octabromobiphenyl		ND	5	-
Nonabromobiphenyl		ND	5	-
Decabromobiphenyl		ND	5	-
Sum of PBDEs (Note 4)	(5)	ND	-	1000
Monobromodiphenyl ether		ND	5	-
Dibromodiphenyl ether		ND	5	-
Tribromodiphenyl ether		ND	5	-
Tetrabromodiphenyl ether		ND	5	-
Pentabromodiphenyl ether		ND	5	-
Hexabromodiphenyl ether		ND	5	-
Heptabromodiphenyl ether		ND	5	-
Octabromodiphenyl ether		ND	5	-
Nonabromodiphenyl ether		ND	5	-
Decabromodiphenyl ether		ND	5	-
Sum of PBDEs (Mono to Deca)		ND	-	-

### Test Part Description:

1. Red plastic wire with black printing

### Note:

- (1) mg/kg = ppm
- (2) ND = Not Detected
- (3) MDL = Method Detection Limit
- (4) Sum of Mono to NonaBDE & according to 2005/717/EC DecaBDE is 1000
- (5) "-" = Not Regulated
- (6) The maximum permissible limit is quoted from the document 2005/717/EC amending RoHS directive 2002/95/EC



Sample photo:



SGS authenticate the photo on original report only

\*\*\* End of Report \*\*\*



## Test Report

No. SH7136501/CHEM

Date: Nov. 14, 2007

Page 1 of 3

KAI TAT INDUSTRIES CO  
CHANGZHEN GONGMING TOWN SHENZHEN CITY

The following sample(s) was/were submitted and identified by/on behalf of the client as:

Sample Name : WIRE GREEN  
SGS Ref No. : SZ10683921-9.5  
Sample Information : 1007, 1015, 1061, 1571, 20276, 1095, 2468, 1617, 1672, 彩排线, 油墨及印字

Sample Receiving Date : Nov.12, 2007  
Testing Period : Nov.12 - 14, 2007

Test Requested : In accordance with the RoHS Directive 2002/95/EC, and its amendment directives.

Test Method : With reference to IEC 62321, Ed.1 111/54/CDV  
Procedures for the Determination of Levels of Regulated Substances in  
Electrotechnical Products  
(1) Determination of Cadmium by ICP.  
(2) Determination of Lead by ICP.  
(3) Determination of Mercury by ICP.  
(4) Determination of Hexavalent Chromium by Colorimetric Method.  
(5) Determination of PBBs and PBDEs by GC/MS.

Test Results : Please refer to next pages

Conclusion : Based on the performed tests on submitted samples, the results comply with the  
RoHS Directive 2002/95/EC and its subsequent amendments.

Signed for and on behalf of  
SGS-CSTC Chemical Laboratory



Ella Zhang  
Section Manager

Signed for and on behalf of  
SGS-CSTC Chemical Laboratory



Sandy Hao  
Lab Manager



## Test Report

No. SH7136501/CHEM

Date: Nov. 14, 2007

Page 2 of 3

Test results by chemical method (Unit: mg/kg)

Test Item(s):	Method (refer to)	1	MDL	RoHS Limit
Cadmium(Cd)	(1)	ND	2	100
Lead (Pb)	(2)	ND	2	1000
Mercury (Hg)	(3)	ND	2	1000
Hexavalent Chromium (CrVI) by alkaline extraction	(4)	ND	2	1000
Sum of PBBs		ND	-	1000
Monobromobiphenyl		ND	5	-
Dibromobiphenyl		ND	5	-
Tribromobiphenyl		ND	5	-
Tetrabromobiphenyl		ND	5	-
Pentabromobiphenyl		ND	5	-
Hexabromobiphenyl		ND	5	-
Heptabromobiphenyl		ND	5	-
Octabromobiphenyl		ND	5	-
Nonabromobiphenyl		ND	5	-
Decabromobiphenyl		ND	5	-
Sum of PBDEs (Note 4)	(5)	ND	-	1000
Monobromodiphenyl ether		ND	5	-
Dibromodiphenyl ether		ND	5	-
Tribromodiphenyl ether		ND	5	-
Tetrabromodiphenyl ether		ND	5	-
Pentabromodiphenyl ether		ND	5	-
Hexabromodiphenyl ether		ND	5	-
Heptabromodiphenyl ether		ND	5	-
Octabromodiphenyl ether		ND	5	-
Nonabromodiphenyl ether		ND	5	-
Decabromodiphenyl ether		ND	5	-
Sum of PBDEs (Mono to Deca)		ND	-	-

### Test Part Description:

- Green plastic wire



## Test Report

No. SH7136501/CHEM

Date: Nov. 14, 2007

Page 3 of 3

### Note:

- (1) mg/kg = ppm
- (2) ND = Not Detected
- (3) MDL = Method Detection Limit
- (4) Sum of Mono to NonaBDE & according to 2005/717/EC DecaBDE is exempt
- (5) "-" = Not Regulated
- (6) The maximum permissible limit is quoted from the document 2005/618/EC amending RoHS directive 2002/95/EC

### Sample photo:



SGS authenticate the photo on original report only

\*\*\* End of Report \*\*\*



## Test Report

No. SH7136499/CHEM

Date: Nov. 14, 2007

Page 1 of 3

KAI TAT INDUSTRIES CO  
CHANGZHEN GONGMING TOWN SHENZHEN CITY

The following sample(s) was/were submitted and identified by/on behalf of the client as:

Sample Name : WIRE PURPLE  
SGS Ref No. : SZ10683921-9.3  
Sample Information : 1007, 1015, 1061, 1571, 20276, 1095, 2468, 1617, 1672, 彩排线, 油墨及印字

Sample Receiving Date : Nov.12, 2007  
Testing Period : Nov.12 - 14, 2007

Test Requested : In accordance with the RoHS Directive 2002/95/EC, and its amendment directives.

Test Method : With reference to IEC 62321, Ed.1 111/54/CDV  
Procedures for the Determination of Levels of Regulated Substances in  
Electrotechnical Products  
(1) Determination of Cadmium by ICP.  
(2) Determination of Lead by ICP.  
(3) Determination of Mercury by ICP.  
(4) Determination of Hexavalent Chromium by Colorimetric Method.  
(5) Determination of PBBs and PBDEs by GC/MS.

Test Results : Please refer to next pages

Conclusion : Based on the performed tests on submitted samples, the results comply with the  
RoHS Directive 2002/95/EC and its subsequent amendments.

Signed for and on behalf of  
SGS-CSTC Chemical Laboratory



Ella Zhang  
Section Manager

Signed for and on behalf of  
SGS-CSTC Chemical Laboratory



Sandy Hao  
Lab Manager





Test results by chemical method (Unit: mg/kg)

Test Item(s):	Method (refer to)	1	MDL	RoHS Limit
Cadmium(Cd)	(1)	ND	2	100
Lead (Pb)	(2)	ND	2	1000
Mercury (Hg)	(3)	ND	2	1000
Hexavalent Chromium (CrVI) by alkaline extraction	(4)	ND	2	1000
Sum of PBBs		ND	-	1000
Monobromobiphenyl		ND	5	-
Dibromobiphenyl		ND	5	-
Tribromobiphenyl		ND	5	-
Tetrabromobiphenyl		ND	5	-
Pentabromobiphenyl		ND	5	-
Hexabromobiphenyl		ND	5	-
Heptabromobiphenyl		ND	5	-
Octabromobiphenyl		ND	5	-
Nonabromobiphenyl		ND	5	-
Decabromobiphenyl		ND	5	-
Sum of PBDEs (Note 4)	(5)	ND	-	1000
Monobromodiphenyl ether		ND	5	-
Dibromodiphenyl ether		ND	5	-
Tribromodiphenyl ether		ND	5	-
Tetrabromodiphenyl ether		ND	5	-
Pentabromodiphenyl ether		ND	5	-
Hexabromodiphenyl ether		ND	5	-
Heptabromodiphenyl ether		ND	5	-
Octabromodiphenyl ether		ND	5	-
Nonabromodiphenyl ether		ND	5	-
Decabromodiphenyl ether		ND	5	-
Sum of PBDEs (Mono to Deca)		ND	-	-

**Test Part Description:**

1. Purple plastic wire



## Test Report

No. SH7136499/CHEM

Date: Nov. 14, 2007

Page 3 of 3

Note:

- (1) mg/kg = ppm
- (2) ND = Not Detected
- (3) MDL = Method Detection Limit
- (4) Sum of Mono to NonaBDE & according to 2005/717/EC DecaBDE is exempt
- (5) "-" = Not Regulated
- (6) The maximum permissible limit is quoted from the document 2005/618/EC amending RoHS directive 2002/95/EC

Sample photo:



SGS authenticate the photo on original report only

\*\*\* End of Report \*\*\*



## Test Report

No. SH7136500/CHEM

Date: Nov. 14, 2007

Page 1 of 3

KAITAT INDUSTRIES CO  
CHANGZHEN GONGMING TOWN SHENZHEN CITY

The following sample(s) was/were submitted and identified by/on behalf of the client as:

Sample Name : WIRE GREY  
SGS Ref No. : SZ10683921-9.4  
Sample Information : 1007, 1015, 1061, 1571, 20276, 1095, 2468, 1617, 1672, 彩排线, 油墨及印字

Sample Receiving Date : Nov.12, 2007  
Testing Period : Nov.12 - 14, 2007

Test Requested : In accordance with the RoHS Directive 2002/95/EC, and its amendment directives.

Test Method : (1) With reference to IEC 62321 Ed.1 111/54/CDV for Cadmium content.  
Analysis was performed by ICP.  
(2) With reference to IEC 62321 Ed.1 111/54/CDV for Lead content.  
Analysis was performed by ICP.  
(3) With reference to IEC 62321 Ed.1 111/54/CDV for Mercury content.  
Analysis was performed by ICP.  
(4) With reference to IEC 62321 Ed.1 111/54/CDV for Hexavalent Chromium by  
Colorimetric Method.  
(5) With reference to IEC 62321 Ed.1 111/54/CDV for PBBs / PBDEs content.  
Analysis was performed by GC/MS.

Test Results : Please refer to next pages

Signed for and on behalf of  
SGS-CSTC Chemical Laboratory



Ella Zhang  
Section Manager

Signed for and on behalf of  
SGS-CSTC Chemical Laboratory



Sandy Hao  
Lab Manager



Test results by chemical method (Unit: mg/kg)

Test Item(s):	Method (refer to)	1	MDL	RoHS Limit
Cadmium(Cd)	(1)	ND	2	100
Lead (Pb)	(2)	ND	2	1000
Mercury (Hg)	(3)	ND	2	1000
Hexavalent Chromium (CrVI) by alkaline extraction	(4)	ND	2	1000
Sum of PBBs		ND	-	1000
Monobromobiphenyl		ND	5	-
Dibromobiphenyl		ND	5	-
Tribromobiphenyl		ND	5	-
Tetrabromobiphenyl		ND	5	-
Pentabromobiphenyl		ND	5	-
Hexabromobiphenyl		ND	5	-
Heptabromobiphenyl		ND	5	-
Octabromobiphenyl		ND	5	-
Nonabromobiphenyl		ND	5	-
Decabromobiphenyl		ND	5	-
Sum of PBDEs (Note 4)	(5)	ND	-	1000
Monobromodiphenyl ether		ND	5	-
Dibromodiphenyl ether		ND	5	-
Tribromodiphenyl ether		ND	5	-
Tetrabromodiphenyl ether		ND	5	-
Pentabromodiphenyl ether		ND	5	-
Hexabromodiphenyl ether		ND	5	-
Heptabromodiphenyl ether		ND	5	-
Octabromodiphenyl ether		ND	5	-
Nonabromodiphenyl ether		ND	5	-
Decabromodiphenyl ether		ND	5	-
Sum of PBDEs (Mono to Deca)		ND	-	-

**Test Part Description:**

1. Grey plastic wire with black printing

Note:

- (1) mg/kg = ppm
- (2) ND = Not Detected
- (3) MDL = Method Detection Limit
- (4) Sum of Mono to NonaBDE & according to 2005/717/EC DecaBDE is exempt.
- (5) "-" = Not Regulated
- (6) The maximum permissible limit is quoted from the document 2005/618/EC amending RoHS directive 2002/95/EC



Sample photo:



SGS authenticate the photo on original report only

\*\*\* End of Report \*\*\*



## Test Report

No. SH7136498/CHEM

Date: Nov. 14, 2007

Page 1 of 3

KAI TAT INDUSTRIES CO  
CHANGZHEN GONGMING TOWN SHENZHEN CITY

The following sample(s) was/were submitted and identified by/on behalf of the client as:

Sample Name : WIRE BLUE  
SGS Ref No. : SZ10683921-9.2  
Sample Information : 1007, 1015, 1061, 1571, 20276, 1095, 2468, 1617, 1672, 彩排线, 油墨及印字

Sample Receiving Date : Nov.12, 2007  
Testing Period : Nov.12 - 14, 2007

Test Requested : In accordance with the RoHS Directive 2002/95/EC, and its amendment directives.

Test Method : With reference to IEC 62321, Ed.1 111/54/CDV  
Procedures for the Determination of Levels of Regulated Substances in  
Electrotechnical Products  
(1) Determination of Cadmium by ICP.  
(2) Determination of Lead by ICP.  
(3) Determination of Mercury by ICP.  
(4) Determination of Hexavalent Chromium by Colorimetric Method.  
(5) Determination of PBBs and PBDEs by GC/MS.

Test Results : Please refer to next pages

Conclusion : Based on the performed tests on submitted samples, the results comply with the  
RoHS Directive 2002/95/EC and its subsequent amendments.

Signed for and on behalf of  
SGS-CSTC Chemical Laboratory



Ella Zhang  
Section Manager

Signed for and on behalf of  
SGS-CSTC Chemical Laboratory



Sandy Hao  
Lab Manager



Test results by chemical method (Unit: mg/kg)

Test Item(s):	Method (refer to)	1	MDL	RoHS Limit
Cadmium(Cd)	(1)	ND	2	100
Lead (Pb)	(2)	ND	2	1000
Mercury (Hg)	(3)	ND	2	1000
Hexavalent Chromium (CrVI) by alkaline extraction	(4)	ND	2	1000
Sum of PBBs		ND	-	1000
Monobromobiphenyl		ND	5	-
Dibromobiphenyl		ND	5	-
Tribromobiphenyl		ND	5	-
Tetrabromobiphenyl		ND	5	-
Pentabromobiphenyl		ND	5	-
Hexabromobiphenyl		ND	5	-
Heptabromobiphenyl		ND	5	-
Octabromobiphenyl		ND	5	-
Nonabromobiphenyl		ND	5	-
Decabromobiphenyl		ND	5	-
Sum of PBDEs (Note 4)	(5)	ND	-	1000
Monobromodiphenyl ether		ND	5	-
Dibromodiphenyl ether		ND	5	-
Tribromodiphenyl ether		ND	5	-
Tetrabromodiphenyl ether		ND	5	-
Pentabromodiphenyl ether		ND	5	-
Hexabromodiphenyl ether		ND	5	-
Heptabromodiphenyl ether		ND	5	-
Octabromodiphenyl ether		ND	5	-
Nonabromodiphenyl ether		ND	5	-
Decabromodiphenyl ether		ND	5	-
Sum of PBDEs (Mono to Deca)		ND	-	-

**Test Part Description:**

1. Blue plastic wire



## Test Report

No. SH7136498/CHEM

Date: Nov. 14, 2007

Page 3 of 3

Note:

- (1) mg/kg = ppm
- (2) ND = Not Detected
- (3) MDL = Method Detection Limit
- (4) Sum of Mono to NonaBDE & according to 2005/717/EC DecaBDE is exempt
- (5) "-" = Not Regulated
- (6) The maximum permissible limit is quoted from the document 2005/618/EC amending RoHS directive 2002/95/EC

Sample photo:

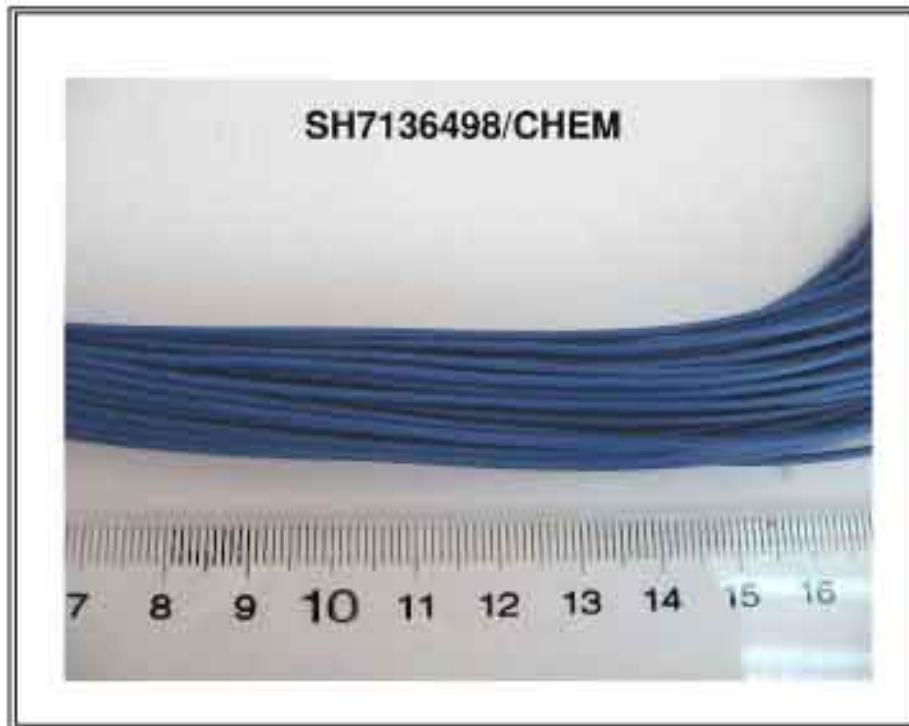

SGS authenticate the photo on original report only

\*\*\* End of Report \*\*\*







## Test Report

No.: GZ0708111170/CHEM

Date: AUG 10, 2007

Page 1 of 4

FENG CHUN COPPER WIRE (SHENZHEN) CO., LTD.  
NO.2 INDUSTRIAL AREA, CHANG ZHEN, GONG MING TOWN, BAO AN DISTRICT, SHEN ZHEN CITY, GUANG  
DONG PROVINCE, P.R.CHINA

The following sample(s) was/were submitted and identified on behalf of the applicant as TA

SGS Ref No. : SZ10511180-2.1  
Sample Receiving Date : AUG 06, 2007  
Testing Period : AUG 06, 2007 TO AUG 10, 2007

Test Requested : With reference to SONY SS-00259  
To determine the Cadmium, Lead, Mercury & Hexavalent Chromium content in the submitted sample.

Test Method : HNO<sub>3</sub>/HCl/HF/Aqua Regia acid digestion.  
(1) Determination of Cadmium by ICP.  
(2) Determination of Lead by ICP.  
(3) Determination of Mercury by ICP.

As specified by client, with reference to JIS H8625-1993.  
(4) Determination of Hexavalent Chromium by UV-Vis Spectrometry.

Test Results : Please refer to next page.

Signed for and on behalf of  
SGS-CSTC Ltd.

Jiang YongPing, Terry  
Sr. Engineer



Test results by chemical method (Unit: mg/kg)

Test Item(s):	Method (refer to)	No.1	MDL
Cadmium(Cd)	(1)	N.D.	2
Lead (Pb)	(2)	N.D.	2
Mercury (Hg)	(3)	N.D.	2
Hexavalent Chromium (CrVI) by boiling water extraction	(4)	N.D.	0.02µg/cm <sup>2</sup>

Test Part Description:

No.1 Silvery plated metal wire

Note : 1. mg/kg = ppm

2. N.D. = Not Detected (< MDL)

3. MDL = Method Detection Limit



**ATTACHMENTS**

**Testing Flow Chart**

- 1) Name of the person who made measurement: David Shen
- 2) Name of the person in charge of measurement: Emily Feng
- 3) These samples were dissolved totally by pre-conditioning method according to below flow chart.  
(Cr<sup>6+</sup> test method excluded)

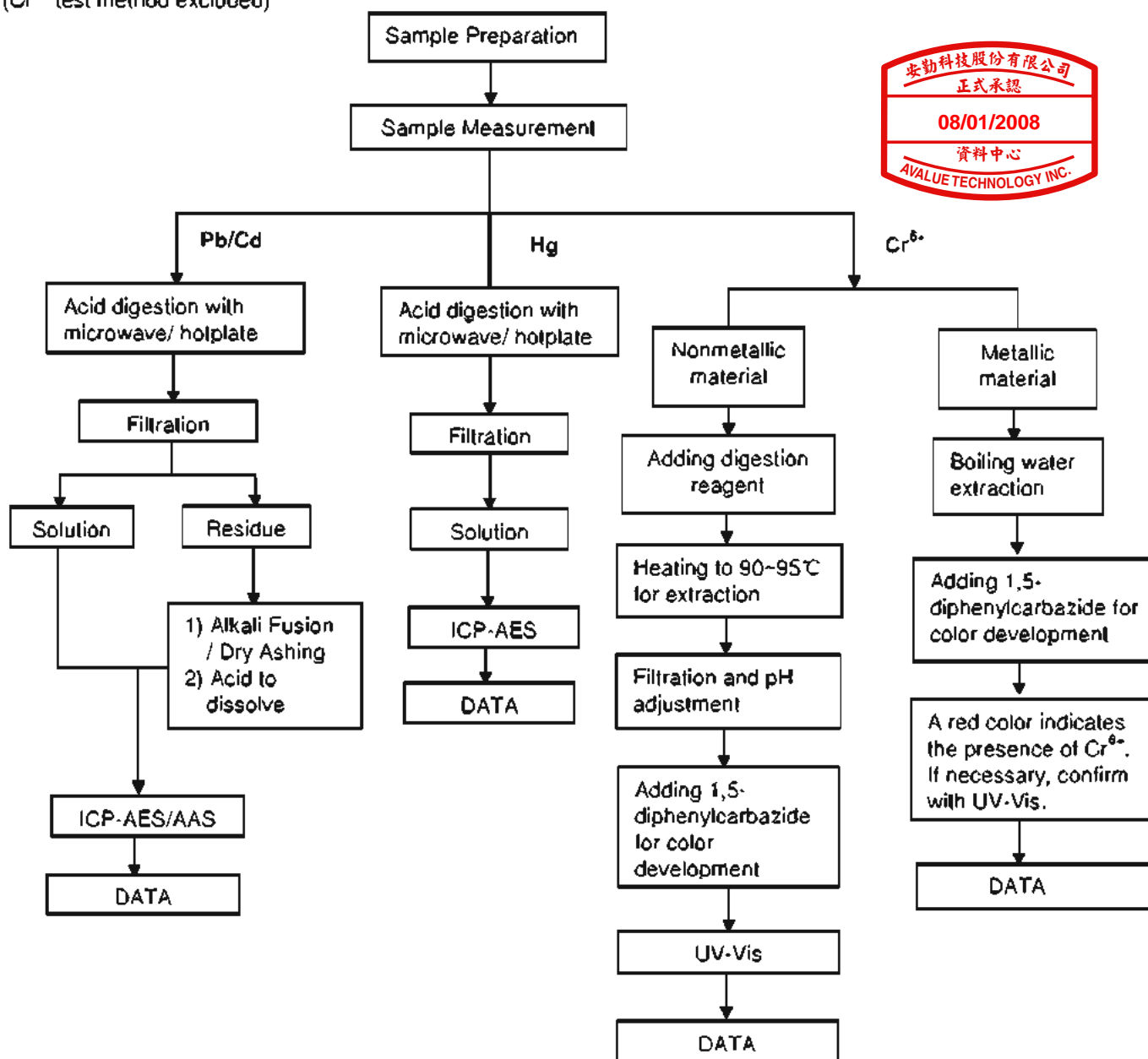

Sample photo :



SGS authenticate the photo on original report only

\*\*\* End of Report \*\*\*





## Test Report

No.: GZ0708111172/CHEM

Date: AUG 10, 2007

Page 1 of 4

FENG CHUN COPPER WIRE (SHENZHEN) CO., LTD.  
NO.2 INDUSTRIAL AREA, CHANG ZHEN, GONG MING TOWN, BAO AN DISTRICT, SHEN ZHEN CITY, GUANG  
DONG PROVINCE, P.R.CHINA

The following sample(s) was/were submitted and identified on behalf of the applicant as BA

SGS Ref No. : SZ10511180-2.2  
Sample Receiving Date : AUG 06, 2007  
Testing Period : AUG 06, 2007 TO AUG 10, 2007

Test Requested : With reference to SONY SS-00259  
To determine the Cadmium, Lead, Mercury & Hexavalent Chromium content in the submitted sample.

Test Method : HNO<sub>3</sub>/HCl/HF/Aqua Regia acid digestion.  
(1) Determination of Cadmium by ICP.  
(2) Determination of Lead by ICP.  
(3) Determination of Mercury by ICP.

As specified by client, with reference to JIS H8625-1993.  
(4) Determination of Hexavalent Chromium by UV-Vis Spectrometry.

Test Results : Please refer to next page.



Signed for and on behalf of  
SGS-CSTC Ltd.

Jiang YongPing, Terry  
Sr. Engineer

Test results by chemical method (Unit: mg/kg)

Test Item(s):	Method (refer to)	No.1	MDL
Cadmium(Cd)	(1)	N.D.	2
Lead (Pb)	(2)	N.D.	2
Mercury (Hg)	(3)	N.D.	2
Hexavalent Chromium (CrVI) by boiling water extraction	(4)	N.D.	0.02µg/cm <sup>2</sup>

Test Part Description:

No.1 Copper-colored metal wire

Note : 1. mg/kg = ppm

2. N.D. = Not Detected (< MDL)

3. MDL = Method Detection Limit



## ATTACHMENTS

### Testing Flow Chart

- 1) Name of the person who made measurement: David Shen
- 2) Name of the person in charge of measurement: Emily Feng
- 3) These samples were dissolved totally by pre-conditioning method according to below flow chart.  
(Cr<sup>6+</sup> test method excluded)

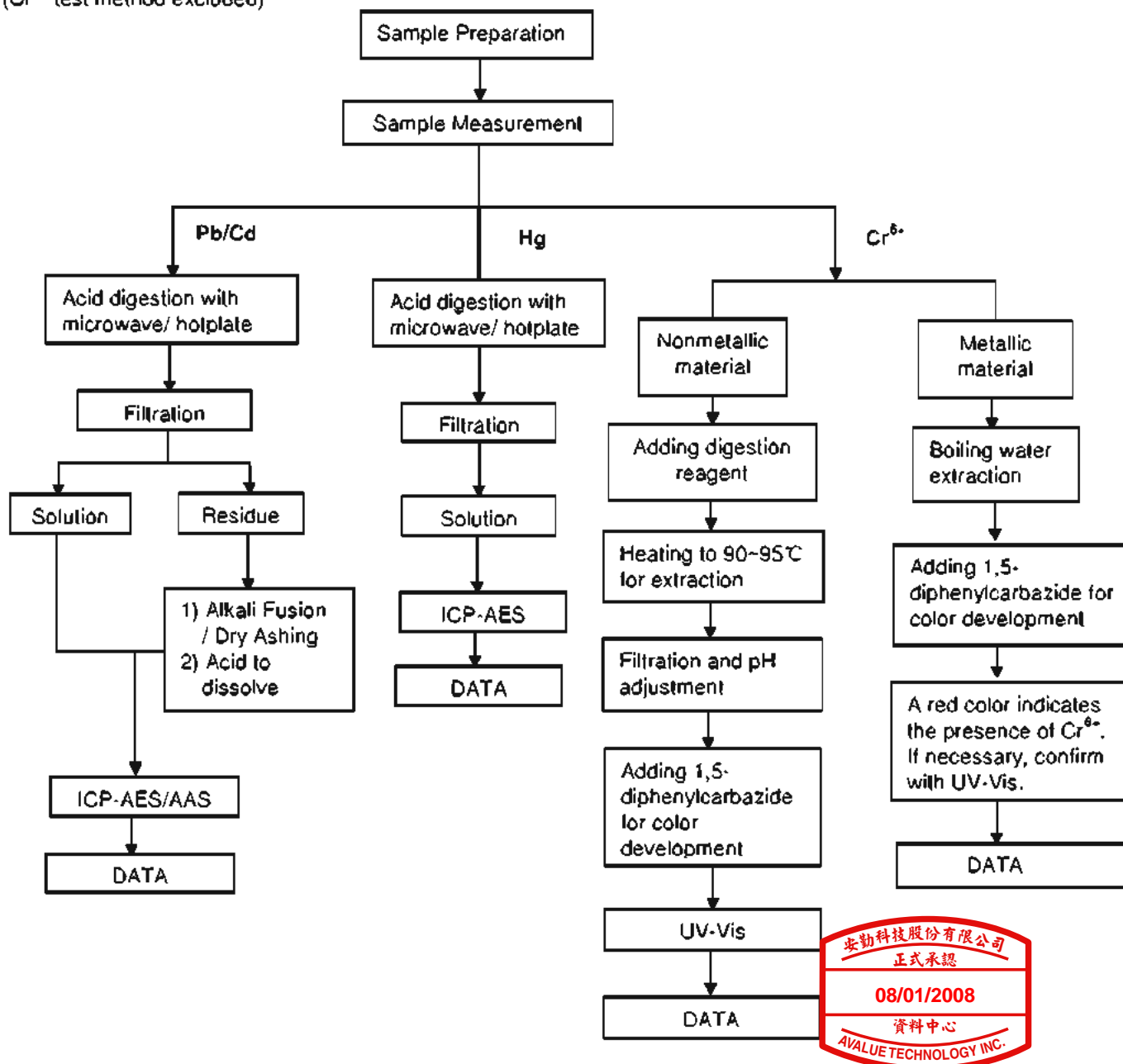

Sample photo :



SGS authenticate the photo on original report only

\*\*\* End of Report \*\*\*





# UL 资 料 认 证 卡

**AVLV8**

**July 12, 2001**

**Appliance Wiring Material Certified For Canada—Component  
KAITAT INDUSTRIES CO**

**CHANG ZHEN VILLAGE GONGMING CITY SHEN ZHEN  
GUANGDONG CHINA**

**E214382**

Appliance wiring material, Type AWM, Class I Class II Class III, Group A  
Marking, product name and the Recognized Component Mark for Canada. On the  
attached tag, the reel or the smallest unit container in which the product is packaged

---

## LOOK FOR THE RECOGNITION MARK

See General Information Preceding These Recognitions  
For use only in equipment where the acceptability of the combination is determined by  
Underwriters Laboratories Inc.

**8/9/2001**

**Underwriters Laboratories Inc.**

**Card 1 of 1**





# 东莞市创佳塑胶电子制品有限公司

ADD: 东莞市横沥镇新城工业区

TEL: 0769-8607 1307

FAX: 0769-8189 0655

## 热缩管送样规格书

第1页共1页

T O: 桥头良泰  
C C: 安小姐  
TEL: 0769-8342 8236

N O: YP07091001  
送样人: 张伟  
送样日期: 2007-09-10

类型	规格 (mm)	收缩前尺寸 (mm)		收缩后尺寸 (mm)		包装 (米/盘)	色彩	送样数	备注
		内径	壁厚	内径	壁厚				
双壁管	φ9.5	9.50±0.30		4.8	0.9±0.15	50	黑	1m	2倍收缩
双壁管	φ9.5	9.50±0.30		3.2	1.65	50	黑	1m	3倍收缩
双壁管	φ12.7	12.70±0.50		4.2	0.50±0.08	1.22	黑	1m	3倍收缩
普通热缩管	φ1.0	1.50±0.30	0.18±0.05	0.60	0.35±0.05	200	黑	1m	
普通热缩管	φ2.0	2.5±0.30	0.18±0.05	1.00	0.42±0.05	200	黑	1m	
普通热缩管	φ3.0	3.50±0.40	0.25±0.05	1.50	0.42±0.05	200	黑	1m	
普通热缩管	φ4.0	4.50±0.40	0.25±0.05	2.00	0.42±0.05	200	黑	1m	
普通热缩管	φ5.0	5.50±0.40	0.25±0.05	2.50	0.50±0.08	100	黑	1m	
普通热缩管	φ6.0	6.50±0.40	0.28±0.05	3.00	0.50±0.08	100	黑	1m	
普通热缩管	φ7.0	7.50±0.40	0.30±0.05	3.50	0.55±0.08	100	黑	1m	
普通热缩管	φ8.0	8.50±0.50	0.30±0.05	4.00	0.60±0.08	100	黑	1m	
普通热缩管	φ9.0	9.50±0.50	0.30±0.08	4.50	0.60±0.08	100	黑	1m	
普通热缩管	φ10	10.50±0.50	0.30±0.08	5.00	0.60±0.08	100	黑	1m	
超薄热缩管	φ1.0	1.30±0.30	0.10±0.05	0.60	0.20±0.05	200	黑	1m	
超薄热缩管	φ2.0	2.30±0.30	0.13±0.05	1.00	0.22±0.05	200	黑	1m	
超薄热缩管	φ3.0	3.30±0.40	0.13±0.05	1.50	0.28±0.05	200	黑	1m	
超薄热缩管	φ4.0	4.30±0.40	0.15±0.05	2.00	0.30±0.05	200	黑	1m	
超薄热缩管	φ5.0	5.50±0.40	0.15±0.05	2.50	0.35±0.05	100	黑	1m	
超薄热缩管	φ6.0	6.50±0.40	0.15±0.05	3.00	0.35±0.05	100	黑	1m	
超薄热缩管	φ7.0	7.50±0.40	0.15±0.05	3.50	0.35±0.05	100	黑	1m	
超薄热缩管	φ8.0	8.50±0.50	0.15±0.05	4.00	0.35±0.05	100	黑	1m	
超薄热缩管	φ9.0	9.50±0.50	0.15±0.05	4.50	0.38±0.05	100	黑	1m	
超薄热缩管	φ10	10.50±0.50	0.15±0.05	5.00	0.38±0.05	100	黑	1m	



制表: 何琴



# Test Report

No. EC407501702

Date: Jan 10 2008

Page 1 of 6

SHENZHEN WOER HEAT-SHRINKABLE MATERIAL CO., LTD  
WOER MANSION,  
XINWEI, INDUSTRIAL PARK,  
XILI, NANSHAN,  
SHENZHEN,  
CHINA

The following sample was submitted and identified on behalf of the client as :  
H-BLACK RSFR HEAT SHRINKABLE TUBINGS

SGS Job No. : 1144714  
SGS Reference No : SZ10782918-2.1  
Date of Sample(s) Received : JAN 02 2008  
Testing Period : JAN 02 - 08 2008

- Test Requested/ Test Method :
- To determine Cadmium content in the submitted sample according to IEC 62321 (Ed. 1) 111/54/CDV. Analysis was performed by ICP / AAS.
  - To determine Lead content in the submitted sample according to IEC 62321 (Ed. 1) 111/54/CDV. Analysis was performed by ICP / AAS.
  - To determine Mercury content in the submitted sample according to IEC 62321 (Ed. 1) 111/54/CDV. Analysis was performed by ICP / CV- AAS.
  - To determine PBBs (polybrominated biphenyls) and PBDEs (Polybrominated diphenylethers) in the submitted sample according to IEC 62321 (Ed. 1) 111/54/CDV . Analysis was performed by GC-MS.
  - To determine Chromium, Arsenic, Selenium, Antimony and Barium contents in the submitted sample according to EPA Method 3051A/3052. Analysis was performed by ICP / AAS.
  - To determine Halogen (F, Cl, Br, I) content in the submitted sample according to BS EN14582:2007, by IC Technique.



This document is issued by the Company under its General Conditions of Service printed overleaf or available on request and accessible at [http://www.sgs.com/terms\\_and\\_conditions.htm](http://www.sgs.com/terms_and_conditions.htm). Attention is drawn to the limitation of liability, indemnification and jurisdiction issues defined therein. Any holder of this document is advised that information contained hereon reflects the Company's findings at the time of its intervention only and within the limits of Client's instructions, if any. The Company's sole responsibility is to its Client and this document does not constitute parties to a transaction from exercising all their rights and obligations under the transaction documents. Any unauthorized alteration, forgery or falsification of the content or appearance of this document is unlawful and offenders may be prosecuted to the fullest extent of the law.

Unless otherwise stated the results shown in this test report refer only to the sample(s) tested and such sample(s) are retained for 30 days only. This document cannot be reproduced except in full, without prior approval of the Company.



# Test Report

No. EC407501702

Date: Jan 10 2008

Page 2 of 6

Test Results : Please refer to next page.

Signed for and on behalf of  
SGS Hong Kong Ltd.

Ho Ka Ting Family  
Senior Laboratory Executive



This document is issued by the Company under its General Conditions of Service printed overleaf or available on request and accessible at [http://www.sgs.com/terms\\_and\\_conditions.htm](http://www.sgs.com/terms_and_conditions.htm). Attention is drawn to the limitation of liability, indemnification and jurisdiction issues defined therein. Any holder of this document is advised that information contained hereon reflects the Company's findings at the time of its intervention only and within the limits of Client's instructions, if any. The Company's sole responsibility is to its Client and this document does not constitute parties to a transaction from exercising all their rights and obligations under the transaction documents. Any unauthorized alteration, forgery or falsification of the content or appearance of this document is unlawful and offenders may be prosecuted to the fullest extent of the law.

Unless otherwise stated the results shown in this test report refer only to the sample(s) tested and such sample(s) are retained for 30 days only. This document cannot be reproduced except in full, without prior approval of the Company.



# Test Report

No. EC407501702

Date: Jan 10 2008

Page 3 of 6

## Test Results:

Test results by chemical method (Unit : mg/kg)

	<u>1</u>	<u>MDL</u>
Cadmium (Cd)	n.d.	2
Lead (Pb)	2	2
Mercury (Hg)	n.d.	2
Chromium (Cr)	n.d.	2
<b>Polybrominated Biphenyl (PBBs)</b>	--	
Monobromobiphenyl	n.d.	5
Dibromobiphenyl	n.d.	5
Tribromobiphenyl	n.d.	5
Tetrabromobiphenyl	n.d.	5
Pentabromobiphenyl	n.d.	5
Hexabromobiphenyl	n.d.	5
Heptabromobiphenyl	n.d.	5
Octabromobiphenyl	n.d.	5
Nonabromobiphenyl	n.d.	5
Decabromobiphenyl	n.d.	5
<b>Polybrominated Diphenylethers (PBDEs)</b>	--	
Monobromodiphenyl ether	n.d.	5
Dibromodiphenyl ether	n.d.	5
Tribromodiphenyl ether	n.d.	5
Tetrabromodiphenyl ether	n.d.	5
Pentabromodiphenyl ether	n.d.	5
Hexabromodiphenyl ether	n.d.	5
Heptabromodiphenyl ether	n.d.	5
Octabromodiphenyl ether	n.d.	5
Nonabromodiphenyl ether	n.d.	5
Decabromodiphenyl ether	n.d.	5

### Note:

- (1) Unit : mg/kg = ppm
- (2) MDL = Method Detection Limit
- (3) n.d. = Not Detected



This document is issued by the Company under its General Conditions of Service printed overleaf or available on request and accessible at [http://www.sgs.com/terms\\_and\\_conditions.htm](http://www.sgs.com/terms_and_conditions.htm). Attention is drawn to the limitation of liability, indemnification and jurisdiction issues defined therein. Any holder of this document is advised that information contained hereon reflects the Company's findings at the time of its intervention only and within the limits of Client's instructions, if any. The Company's sole responsibility is to its Client and this document does not constitute parties to a transaction from exercising all their rights and obligations under the transaction documents. Any unauthorized alteration, forgery or falsification of the content or appearance of this document is unlawful and offenders may be prosecuted to the fullest extent of the law.

Unless otherwise stated the results shown in this test report refer only to the sample(s) tested and such sample(s) are retained for 30 days only. This document cannot be reproduced except in full, without prior approval of the Company.



# Test Report

No. EC407501702

Date: Jan 10 2008

Page 4 of 6

## Heavy Metal Test

	<u>1</u>	<u>DL</u>
Arsenic (As)	n.d.	0.001
Selenium (Se)	n.d.	0.001
Antimony (Sb)	n.d.	0.001
Barium (Ba)	0.13	0.001

### Note:

- (1) Unit : % ; 0.01 % = 100 ppm ; ppm = mg/kg
- (2) DL = Detection Limit
- (3) n.d. = Not Detected

## Halogen

	<u>CAS-No.</u>	<u>1</u>	<u>DL</u>
Fluorine (F)	007782-41-4	n.d.	50
Chlorine (Cl)	007782-50-5	n.d.	50
Bromine (Br)	007726-95-6	n.d.	50
Iodine (I)	007553-56-2	n.d.	50

### Note:

- (1) Unit : ppm = mg/kg
- (2) DL = Detection Limit
- (3) n.d. = Not detected

## Sample Description

- 1 Dark Grey Plastic w/ White Printing



This document is issued by the Company under its General Conditions of Service printed overleaf or available on request and accessible at [http://www.sgs.com/terms\\_and\\_conditions.htm](http://www.sgs.com/terms_and_conditions.htm). Attention is drawn to the limitation of liability, indemnification and jurisdiction issues defined therein. Any holder of this document is advised that information contained hereon reflects the Company's findings at the time of its intervention only and within the limits of Client's instructions, if any. The Company's sole responsibility is to its Client and this document does not constitute parties to a transaction from exercising all their rights and obligations under the transaction documents. Any unauthorized alteration, forgery or falsification of the content or appearance of this document is unlawful and offenders may be prosecuted to the fullest extent of the law.

Unless otherwise stated the results shown in this test report refer only to the sample(s) tested and such sample(s) are retained for 30 days only. This document cannot be reproduced except in full, without prior approval of the Company.

Flowchart of Extraction for PBB and PBDE Measurement

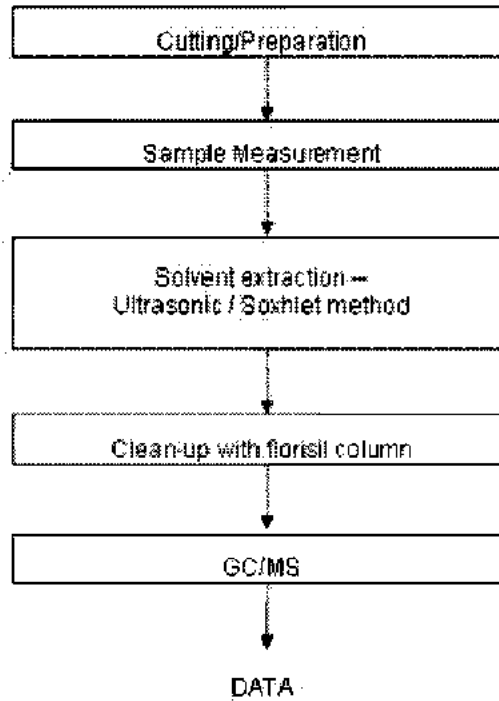

Operator: Lau Chung Yin, Eric

Supervisor: Chan Chi Hung, Dicky



This document is issued by the Company under its General Conditions of Service printed overleaf or available on request and accessible at [http://www.sgs.com/terms\\_and\\_conditions.htm](http://www.sgs.com/terms_and_conditions.htm). Attention is drawn to the limitation of liability, indemnification and jurisdiction issues defined therein. Any holder of this document is advised that information contained hereon reflects the Company's findings at the time of its intervention only and within the limits of Client's instructions, if any. The Company's sole responsibility is to its Client and this document does not constitute parties to a transaction from exercising all their rights and obligations under the transaction documents. Any unauthorized alteration, forgery or falsification of the content or appearance of this document is unlawful and offenders may be prosecuted to the fullest extent of the law.

Unless otherwise stated the results shown in this test report refer only to the sample(s) tested and such sample(s) are retained for 30 days only. This document cannot be reproduced except in full, without prior approval of the Company.

Sample photo:

## EC407501702 (Sample 1)

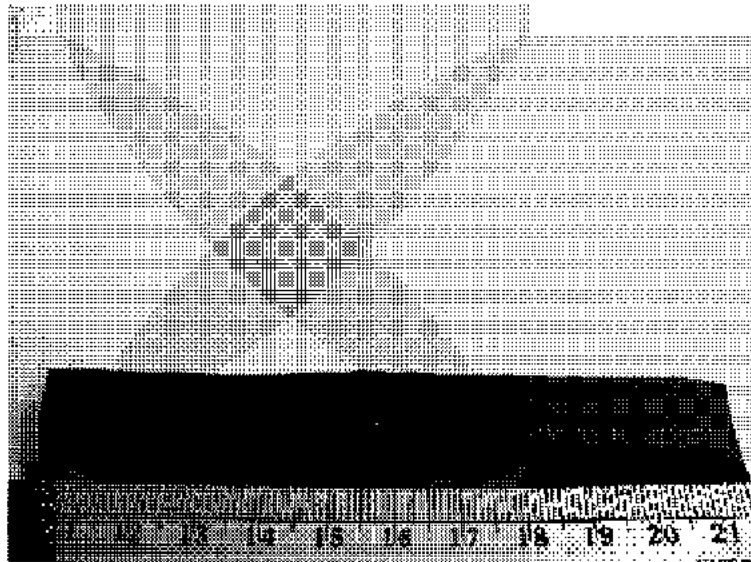

SGS authenticate the photo on original report only

\*\*\* End Of Report \*\*\*



This document is issued by the Company under its General Conditions of Service printed overleaf or available on request and accessible at [http://www.sgs.com/terms\\_and\\_conditions.htm](http://www.sgs.com/terms_and_conditions.htm). Attention is drawn to the limitation of liability, indemnification and jurisdiction issues defined therein. Any holder of this document is advised that information contained hereon reflects the Company's findings at the time of its intervention only and within the limits of Client's instructions, if any. The Company's sole responsibility is to its Client and this document does not allocate parties to a transaction from exercising all their rights and obligations under the transaction documents. Any unauthorized alteration, forgery or falsification of the content or appearance of this document is unlawful and offenders may be prosecuted to the fullest extent of the law.

Unless otherwise stated the results shown in this test report refer only to the sample(s) tested and such sample(s) are retained for 30 days only. This document cannot be reproduced except in full, without prior approval of the Company.



## 铜线编织网规格书 (8目)

总页 | 第 1 页

单位: mm、根

铜丝规格	φ0.10	φ0.12	φ0.16	φ0.254	包装
16股	32	32	32	32	轴装，根据轴型号不同而包装数量不同
	48	48	48	48	
	64	64	64	64	
	80	80	80	80	
	96	96	96	96	
	112	112	112	112	
	128	128	128	128	
24股	48	48	48	48	
	72	72	72	72	
	96	96	96	96	
	120	120	120	120	
	144	144	144	144	
	<b>168</b>	168	168	168	
	192	192	192	192	
	216	216	216	216	
	240	240	240	240	

注: 1、24股、φ0.10、168表示: 24股7根一束的直径0.10mm铜丝编织成合计168根铜丝的铜网，且密度为每英寸有8个交叉点。

2、铜丝有镀锡与裸铜两种，镀锡用T表示。

3、本产品符合RoHS要求。



## Test Report

No. CANEC0801467302

Date: 09 Apr 2008

Page 1 of 4

INKON (SHENZHEN) ELECTRIC MATERIAL CO.,LTD  
BLOCK 18, CHUANGYE INDUSTRIAL ESTATE, SHAPUWEI, SONGGANG, SHENZHEN  
CHINA

The following sample(s) was/were submitted and identified on behalf of the clients as :

管帽线

SGS Job No. : 10932281 - SZ  
 SGS Internal Reference No. : 2.2  
 Date of Sample Received : 03 Apr 2008  
 Testing Period : 03 Apr 2008 - 05 Apr 2008  
 Test Requested : Selected test(s) as requested by client.  
 Test Method : Please refer to next page(s).  
 Test Results : Please refer to next page(s).  
 Conclusion : Based on the performed tests on submitted sample(s), the results comply with the RoHS Directive 2002/95/EC and its subsequent amendments.

Signed for and on behalf of  
SGS-CSTC Ltd.

Huang Fang, Sunny  
Sr. Engineer



To: 王小姐  
From: 张一凡 (金川佳)

This document is issued by the Company under its General Conditions of Service printed overleaf or available on request and accessible at [http://www.sgs.com/terms\\_and\\_conditions](http://www.sgs.com/terms_and_conditions).  
 Note: Attention is drawn to the limitation of liability, indemnification and jurisdiction issues defined therein. Any holder of this document is advised that information contained hereon reflects the Company's findings at the time of its intervention only and within the limits of Client's instructions, if any. The Company's sole responsibility is to its Client and this document does not constitute a guarantee or warranty for any transaction or any other purpose. The Client is advised to exercise all their rights and obligations under the transaction documents. Any unauthorized alteration, forgery or falsification of the content or appearance of this document is unlawful and offenders may be prosecuted to the fullest extent of the law.  
 Unless otherwise stated, the results shown in this test report refer only to the sample(s) tested and such sample(s) are retained for 30 days only. This document cannot be reproduced except in full, without prior approval of the Company.



## Test Report

No. CANEC0801487302

Date: 09 Apr 2008

Page 2 of 4

### Test Results:

ID for specimen 1 : CAN08-014873.002  
 Description for specimen 1 : Silvery plated metal wire

### RoHS Directive 2002/95/EC

Test Item(s)	Unit	Test Method (Reference)	Result	MDL	Limit
Cadmium (Cd)	mg/kg	IEC 62321/2nd CDV (111/95/CDV), ICP-OES	N.D.	2	100
Lead (Pb)	mg/kg	IEC 62321/2nd CDV (111/95/CDV), ICP-OES	64	2	1000
Mercury (Hg)	mg/kg	IEC 62321/2nd CDV (111/95/CDV), ICP-OES	N.D.	2	1000
Hexavalent Chromium (CrVI) by boiling water extraction	-	IEC 62321/2nd CDV (111/95/CDV), UV-Vis	Negative	◇	■
Sum of PBBs	mg/kg	-	N.D.	-	1000
Monobromobiphenyl	mg/kg	IEC 62321/2nd CDV (111/95/CDV), GC-MS	N.D.	5	
Dibromobiphenyl	mg/kg	IEC 62321/2nd CDV (111/95/CDV), GC-MS	N.D.	5	
Tribromobiphenyl	mg/kg	IEC 62321/2nd CDV (111/95/CDV), GC-MS	N.D.	5	
Tetrabromobiphenyl	mg/kg	IEC 62321/2nd CDV (111/95/CDV), GC-MS	N.D.	5	
Pentabromobiphenyl	mg/kg	IEC 62321/2nd CDV (111/95/CDV), GC-MS	N.D.	5	
Hexabromobiphenyl	mg/kg	IEC 62321/2nd CDV (111/95/CDV), GC-MS	N.D.	5	
Heptabromobiphenyl	mg/kg	IEC 62321/2nd CDV (111/95/CDV), GC-MS	N.D.	5	
Octabromobiphenyl	mg/kg	IEC 62321/2nd CDV (111/95/CDV), GC-MS	N.D.	5	
Nonabromobiphenyl	mg/kg	IEC 62321/2nd CDV (111/95/CDV), GC-MS	N.D.	5	
Decabromobiphenyl	mg/kg	IEC 62321/2nd CDV (111/95/CDV), GC-MS	N.D.	5	
Sum of PBDEs (Mono to Nona) (Note 4)	mg/kg	-	N.D.	-	1000
Monobromodiphenyl ether	mg/kg	IEC 62321/2nd CDV (111/95/CDV), GC-MS	N.D.	5	
Dibromodiphenyl ether	mg/kg	IEC 62321/2nd CDV (111/95/CDV), GC-MS	N.D.	5	
Tribromodiphenyl ether	mg/kg	IEC 62321/2nd CDV (111/95/CDV), GC-MS	N.D.	5	
Tetrabromodiphenyl ether	mg/kg	IEC 62321/2nd CDV (111/95/CDV), GC-MS	N.D.	5	
Pentabromodiphenyl ether	mg/kg	IEC 62321/2nd CDV (111/95/CDV), GC-MS	N.D.	5	
Hexabromodiphenyl ether	mg/kg	IEC 62321/2nd CDV (111/95/CDV), GC-MS	N.D.	5	
Heptabromodiphenyl ether	mg/kg	IEC 62321/2nd CDV (111/95/CDV), GC-MS	N.D.	5	
Octabromodiphenyl ether	mg/kg	IEC 62321/2nd CDV (111/95/CDV), GC-MS	N.D.	5	
Nonabromodiphenyl ether	mg/kg	IEC 62321/2nd CDV (111/95/CDV), GC-MS	N.D.	5	
Decabromodiphenyl ether	mg/kg	IEC 62321/2nd CDV (111/95/CDV), GC-MS	N.D.	5	
Sum of PBDEs (Mono to Deca)	mg/kg	-	N.D.	-	



This document is issued by the Company under its General Conditions of Service printed overleaf or available on request and accessible at [http://www.sgs.com/terms\\_and\\_conditions.html](http://www.sgs.com/terms_and_conditions.html). Attention is drawn to the limitation of liability, indemnification and jurisdiction issues defined therein. Any holder of this document is advised that information contained hereon reflects the Company's findings at the time of its intervention only and within the limits of Client's instructions, if any. The Company's sole responsibility is to its Client and this document does not generate parties to a transaction from exercising all their rights and obligations under the transaction documents. Any unauthorized alteration, forgery or falsification of the content or appearance of this document is unlawful and offenders may be prosecuted to the fullest extent of the law. Unless otherwise stated, the results shown in this test report refer only to the sample(s) tested and such sample(s) are retained for 30 days only. This document cannot be reproduced except in full, without prior approval of the Company.



SGS S.p.A. - SGS S.p.A. - SGS S.p.A. | 中国·广州·经济技术开发区科学城科珠路198号 邮编: 510663 | (86-20) 82155555 | (86-20) 82075125 | www.cn.sgs.com | (86-20) 82155555 | (86-20) 82075125 | sgs.china@sgs.com

**Notes:**

1. mg/kg = ppm
2. N.D. = Not Detected (< MDL)
3. MDL = Method Detection Limit
4. Sum of Mono to NonaBDE & according to 2005/717/EC DecaBDE is exempt.
5. ◊ = Spot-Test

Negative = Absence of CrVI coating, Positive = Presence of CrVI coating;

(The tested sample should be further verified by boiling-water-extraction method if the spot test result is negative or cannot be confirmed.)

**Boiling-water-extraction:**

Negative = Absence of CrVI coating

Positive = Presence of CrVI coating; the detected concentration in boiling-water-extraction solution is equal or greater than 0.02 mg/kg with 50 cm<sup>2</sup> sample surface area.

8. # = Positive indicates the presence of CrVI on the tested areas.

Negative indicates the absence of CrVI on the tested areas.

7. "-" = Not regulated



This document is issued by the Company under its General Conditions of Service printed overseas or available on request and accessible at [http://www.sgs.com/home\\_3DR\\_condit1005](http://www.sgs.com/home_3DR_condit1005). Attention is drawn to the limitation of liability, indemnification and jurisdiction issues defined therein. Any holder of this document is advised that information contained herein reflects the Company's findings at the time of its intervention only and within the limits of Client's instructions, if any. The Company's sole responsibility is to its Client and the accuracy, completeness, timeliness and appearance of this document is unlawful and offenders may be prosecuted to the fullest extent of the law. Any unauthorized alteration, forgery or falsification of the content or appearance of this document is unlawful and offenders may be prosecuted to the fullest extent of the law. This document cannot be reproduced or stored in a retrieval system without prior approval of the Company.



116 Xinhua Road, SCENTECH Park, Guangzhou, China & Technology Development Center, Guangzhou, China 510663  
中国 - 广州 - 经济技术开发区科学城翔鹭路196号 邮编: 510663  
t (86-20) 82155555 f (86-20) 82075125 www.cn.sgs.com  
t (86-20) 82155555 f (86-20) 82075125 c sgs.china@sgs.com

Sample photo:



SGS authenticates the photo on original report only

\*\*\* End of Report \*\*\*



This document is issued by the Company under its General Conditions of Service printed available on request and accessible at [http://www.sgs.com/97981\\_and\\_conditions](http://www.sgs.com/97981_and_conditions).  
SGS, AVALUE, is given to the Addressee of delivery, identification and certification issued without charge. Any holder of this document is advised that information contained hereby reflects the findings of findings at the time of its intervention only and within the terms of Client's instructions, if any. The Company's basic responsibility is to its Client and the necessary steps shall be taken to ensure that the Client is a transaction from exercising all their rights and obligations under the mentioned documents. Any unauthorized alteration, copying or distribution of this document or appearance of this document is unlawful and offenders may be prosecuted to the fullest extent of the law.  
Without otherwise stated, results shown in this report refer only to the sample(s) tested and such sample(s) are retained for 30 days only. This document should be reproduced or stored in any form without prior approval of the Company.



SGS (China) Co., Ltd.  
Guangzhou

Address: 200000 Guangzhou, China  
中国 - 广州 - 经济技术开发区科丰路科丰路166号 邮编: 510663

Tel: (86-20) 82156656  
Fax: (86-20) 82156656

Tel: (86-20) 82075125  
Fax: (86-20) 82075125

www.china.sgs.com  
# sgchina@sgs.com



**Underwriters  
Laboratories Inc.®**

455 East Trimble Rd  
San Jose, CA 95131-1230 USA  
www.ul.com  
tel: 1 408 754 6500  
fax: 1 408 689 6500

05CA43491  
E203950 - YDPU2/YDPU8

January 23, 2006

SHENZHEN WOER HEAT SHRINKABLE MATERIAL CO LTD.  
Shenzhen, CHINA

Attention: **Mr. Yorway Shore**  
Subject: **Flexible Heat Shrinkable Polyolefin tubing - Cat. No. RSFR-H, using modified grade EVA 14-2, rated 125C, 600V, All Colors Except Clear, VW-1 Flame, 2.36 to 75.0 mm recovered ID**

Dear Mr. Shore:

**NOTICE OF AUTHORIZATION TO APPLY THE UL RECOGNITION MARK**

UL's investigation of your product has been completed under project number **05CA43491** and the product was determined to comply with the applicable requirements.

This fax temporarily supplements the UL Follow-Up Services Inspection Procedure and serves as authorization to apply the UL Recognized Marking only at the factories under UL's Follow-Up Service Program to the products which are constructed as described below:

**Cat. No. RSFR-H, as described above and on the attached Description pages, which were submitted for this investigation. The UL Records covering the initial testing of this product can be found in the UL Follow-Up Services Inspection Procedure, E203950, Vol. 2, Sec. 1.**

This authorization is effective from the date of this Notice and only for products at the indicated manufacturing locations. Records in the Follow-Up Services Procedure covering the product are now being prepared and will be sent to the indicated manufacturing locations in the near future. Please note that Follow-Up Services Procedures are sent to the manufacturers only unless the Applicant specifically requests this document.

Products that bear the UL Recognition Mark shall be identical to those that were evaluated by UL and found to comply with UL's requirements. If changes in construction are discovered, appropriate action will be taken for products not in conformance with UL's requirements and continued use of the UL Recognition Mark may be withdrawn.

Very truly yours,

Reviewed by:

CELESTE CAPULONG (x 32161)  
Project Handler  
Email: [Celeste.Capulong@us.ul.com](mailto:Celeste.Capulong@us.ul.com)

JANEANN MATULICH (x 32536)  
Lead Engineering Associate

A COMMITMENT: ORGANIZATION working for a safer world with integrity, precision and knowledge.



## EXTRUDED TUBING, ELECTRICAL (YDPU2/YDPU8)

Group	Cat. No.	Colors	Procedure Section	Compound	Oil Resistance Temperature Rating	VW-1 Rated
<b>Flexible Heat Shrinkable Polyolefin -</b>						
1	RSFR-x	BK	1	Beijing Chemical EVA (14-2)	None	Yes
	RSFR-x	WT	1	Beijing Chemical EVA (14-2)	None	Yes
	WKZM-x-yz	WT	1	Beijing Chemical EVA (14-2) with Huiyuan ChemicalCo., Ltd. KY-405	None	No
1	RSFR-H	All except CL	1	See Table II	None	Yes
<b>Not Heat Shrinkable PTFE -</b>						
2	WF	NC	2	See Table I	<u>None</u>	Yes

x - Designated tubing expanded ID.

Note: for RSFR-x only, Black color tubing - x represents expanded ID of 2 mm - 8 mm.

Note: for RSFR-x only, White color tubing - x represents expanded ID of 1 mm - 50 mm.

Note: for WKZM-x-yz, - x represents expanded ID of 1 mm - 50 mm and -yz represents any alpha and/or numeric combination for internal Client code

Recovery time and temperature:

RSFR-x: 1 minute at 100C air oven.

WKZM-x-yz and RSFR-H: 3 minutes at 200C air oven.

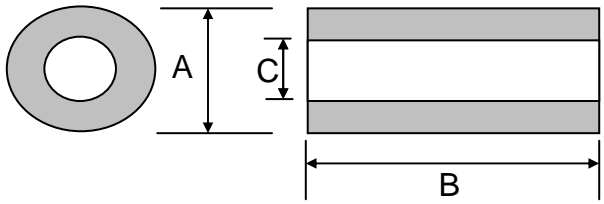
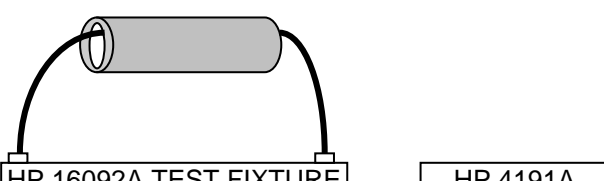

# SPECIFICATION

Customer :	Item : F9S RH4*6*2	13-Mar-08	
Mechanical Assembly		Ref. No :	
		Dimension	
		A	4.00±0.30mm
		B	6.00±0.50mm
		C	2.00±0.30mm
		D	
		E	
		F	
		G	
		H	
Electrical Requirement			
Impedance	MIN 40Ω	Test Frequency 100 MHz	
Impedance	MIN 20Ω	Test Frequency 25MHZ	
Impedance		Test Frequency	
WINDING	0.65 2UEW x 120mm 1TURN		
Test equipment : HP 4191A			
		Wire :	
		Winding : 1 Turn	
		Material : F9S Nickel/Zinc	
		Uiac : 800 ± 25 %	
<b>REMARK :</b>			
<b>Approved by</b>	<b>Checked by</b>	<b>Reported by</b>	
<b>Approved by Customer</b>			

东莞盛磁





## 测试报告

No. CANEC0700973300

日期: 2007年12月14日 第1页,共3页

东莞市盛磁电子有限公司  
中国东莞市塘厦镇石鼓布尾新围41#

以下测试之样品是由申请者所提供及确认:  
F9S 铁粉芯

SGS工作编号 : 10689641 - GZ  
样品接收日期 : 2007年12月11日  
测试周期 : 2007年12月11日 - 2007年12月14日

测试要求 : 委托测试样品中的镉、铅、汞和六价铬的含量。

测试方法 : 参照IEC 62321 Ed.1 111/54/CDV电子电器产品中限用物质含量的测定程序  
(1) 用ICP测定镉的含量  
用ICP测定铅的含量  
用ICP测定汞的含量  
(2) 用比色法测定六价铬的含量

测试结果 : 请参见下一页

通标标准技术服务有限公司  
授权签名



Jiang Yongping, Terry  
Sr. Engineer



备注: 根据客户申请, SGS出具了此中文报告, 英文版本可根据客户要求提供。(The Chinese test report is issued according to the applicant's request. The English version is available from SGS if further needed)

This Test Report is issued by the Company subject to its General Conditions of Service printed overleaf or available on request and accessible at [www.sgs.com](http://www.sgs.com). Attention is drawn to the limitations of liability, indemnification and jurisdictional issues defined therein. Unless otherwise stated the results shown in this test report refer only to the sample(s) tested. This test report cannot be reproduced, except in full, without prior written permission of the Company. Any unauthorized alteration, forgery or falsification of the content or appearance of this report is unlawful and offenders will be prosecuted to the fullest extent of the law.

## 测试报告

No. CANEC0700973300

日期: 2007年12月14日 第2页,共3页

测试结果 (单位: 毫克/千克):

测试项目	参考方法	No.1	MDL
镉 (Cd)	(1)	N.D.	2
铅 (Pb)	(1)	11	2
汞 (Hg)	(1)	N.D.	2
碱性溶液萃取测六价铬(Cr VI)	(2)	N.D.	2

注释:

1. 毫克/千克 = ppm
2. N.D. = 未检出 (< MDL)
3. MDL = 方法检测限

### 测试部件描述

No. 1 深灰色磁芯



This Test Report is issued by the Company subject to its General Conditions of Service printed overleaf or available on request and accessible at [www.sgs.com](http://www.sgs.com). Attention is drawn to the limitations of liability, indemnification and jurisdictional issues defined therein. Unless otherwise stated the results shown in this test report refer only to the sample(s) tested. This test report cannot be reproduced, except in full, without prior written permission of the Company. Any unauthorized alteration, forgery or falsification of the content or appearance of this report is unlawful and offenders will be prosecuted to the fullest extent of the law.

样品照片:



此照片仅限于随SGS正本报告使用

\*\*\* 报告完 \*\*\*



This Test Report is issued by the Company subject to its General Conditions of Service printed overleaf or available on request and accessible at [www.sgs.com](http://www.sgs.com). Attention is drawn to the limitations of liability, indemnification and jurisdictional issues defined therein. Unless otherwise stated the results shown in this test report refer only to the sample(s) tested. This test report cannot be reproduced, except in full, without prior written permission of the Company. Any unauthorized alteration, forgery or falsification of the content or appearance of this report is unlawful and offenders shall be prosecuted to the fullest extent of the law.