

DATA SHEET



BC846; BC847; BC848 NPN general purpose transistors

Product specification
Supersedes data of 1999 Apr 23

2002 Feb 04

NPN general purpose transistors

BC846; BC847; BC848

FEATURES

- Low current (max. 100 mA)
- Low voltage (max. 65 V).

APPLICATIONS

- General purpose switching and amplification.

DESCRIPTION

NPN transistor in a SOT23 plastic package.
 PNP complements: BC856, BC857 and BC858.

MARKING

TYPE NUMBER	MARKING CODE ⁽¹⁾
BC846	1D*
BC846A	1A*
BC846B	1B*
BC847	1H*
BC847A	1E*
BC847B	1F*
BC847C	1G*
BC848B	1K*

Note

- * = p: made in Hong Kong.
 * = t: made in Malaysia.

PINNING

PIN	DESCRIPTION
1	base
2	emitter
3	collector

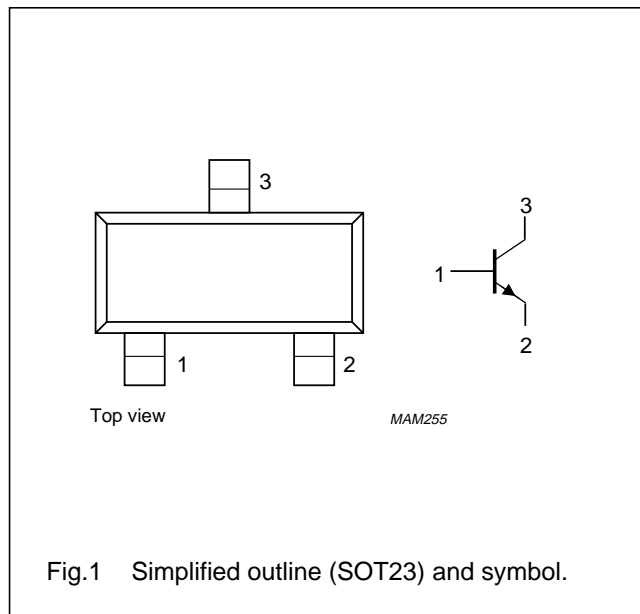

Fig.1 Simplified outline (SOT23) and symbol.

NPN general purpose transistors

BC846; BC847; BC848

LIMITING VALUES

In accordance with the Absolute Maximum System (IEC 60134).

SYMBOL	PARAMETER	CONDITIONS	MIN.	MAX.	UNIT
V _{CBO}	collector-base voltage	open emitter			
	BC846		–	80	V
	BC847		–	50	V
	BC848	–	30	V	
V _{CEO}	collector-emitter voltage	open base			
	BC846		–	65	V
	BC847		–	45	V
	BC848	–	30	V	
V _{EBO}	emitter-base voltage	open collector			
	BC846; BC847		–	6	V
	BC848	–	5	V	
I _C	collector current (DC)		–	100	mA
I _{CM}	peak collector current		–	200	mA
I _{BM}	peak base current		–	200	mA
P _{tot}	total power dissipation	T _{amb} ≤ 25 °C; note 1	–	250	mW
T _{stg}	storage temperature		–65	+150	°C
T _j	junction temperature		–	150	°C
T _{amb}	operating ambient temperature		–65	+150	°C

Note

1. Transistor mounted on an FR4 printed-circuit board, standard footprint.

THERMAL CHARACTERISTICS

SYMBOL	PARAMETER	CONDITIONS	VALUE	UNIT
R _{th j-a}	thermal resistance from junction to ambient	in free air; note 1	500	K/W

Note

1. Transistor mounted on an FR4 printed-circuit board, standard footprint.

NPN general purpose transistors

BC846; BC847; BC848

CHARACTERISTICS

$T_{amb} = 25\text{ °C}$; unless otherwise specified.

SYMBOL	PARAMETER	CONDITIONS	MIN.	TYP.	MAX.	UNIT
I_{CBO}	collector-base cut-off current	$V_{CB} = 30\text{ V}; I_E = 0$	–	–	15	nA
		$V_{CB} = 30\text{ V}; I_E = 0;$ $T_J = 150\text{ °C}$	–	–	5	μA
I_{EBO}	emitter-base cut-off current	$V_{EB} = 5\text{ V}; I_C = 0$	–	–	100	nA
h_{FE}	DC current gain	$I_C = 10\text{ }\mu\text{A}; V_{CE} = 5\text{ V}$	–	90	–	–
	BC846A; BC847A					
	BC846B; BC847B; BC848B		–	150	–	–
	BC847C					
	DC current gain	$I_C = 2\text{ mA}; V_{CE} = 5\text{ V}$	110	–	450	–
	BC846					
	BC847					
	BC846A; BC847A					
	BC846B; BC847B; BC848B					
	BC847C					
V_{CEsat}	collector-emitter saturation voltage	$I_C = 10\text{ mA}; I_B = 0.5\text{ mA}$	–	90	250	mV
		$I_C = 100\text{ mA}; I_B = 5\text{ mA};$ note 1	–	200	600	mV
V_{BEsat}	base-emitter saturation voltage	$I_C = 10\text{ mA}; I_B = 0.5\text{ mA}$	–	700	–	mV
		$I_C = 100\text{ mA}; I_B = 5\text{ mA};$ note 1	–	900	–	mV
V_{BE}	base-emitter voltage	$I_C = 2\text{ mA}; V_{CE} = 5\text{ V}$	580	660	700	mV
		$I_C = 10\text{ mA}; V_{CE} = 5\text{ V}$	–	–	770	mV
C_c	collector capacitance	$V_{CB} = 10\text{ V}; I_E = I_e = 0;$ $f = 1\text{ MHz}$	–	2.5	–	pF
f_T	transition frequency	$V_{CE} = 5\text{ V}; I_C = 10\text{ mA};$ $f = 100\text{ MHz}$	100	–	–	MHz
F	noise figure	$I_C = 200\text{ }\mu\text{A}; V_{CE} = 5\text{ V};$ $R_S = 2\text{ k}\Omega; f = 1\text{ kHz};$ $B = 200\text{ Hz}$	–	2	10	dB

Note

1. Pulse test: $t_p \leq 300\text{ }\mu\text{s}; \delta \leq 0.02$.

NPN general purpose transistors

BC846; BC847; BC848

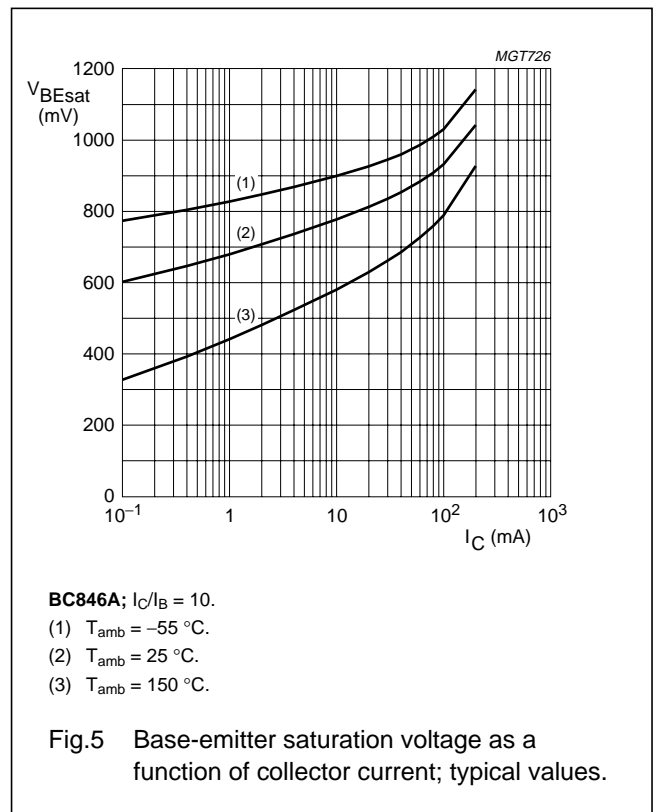
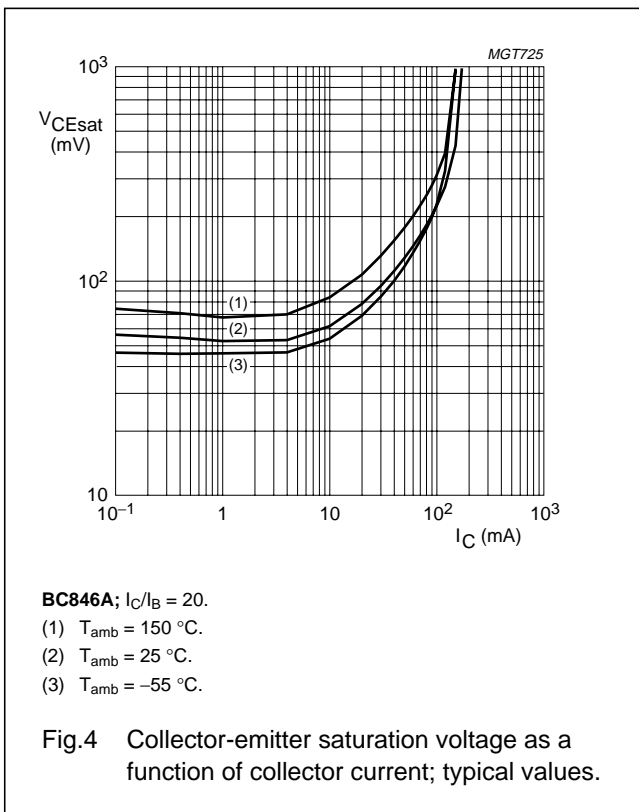
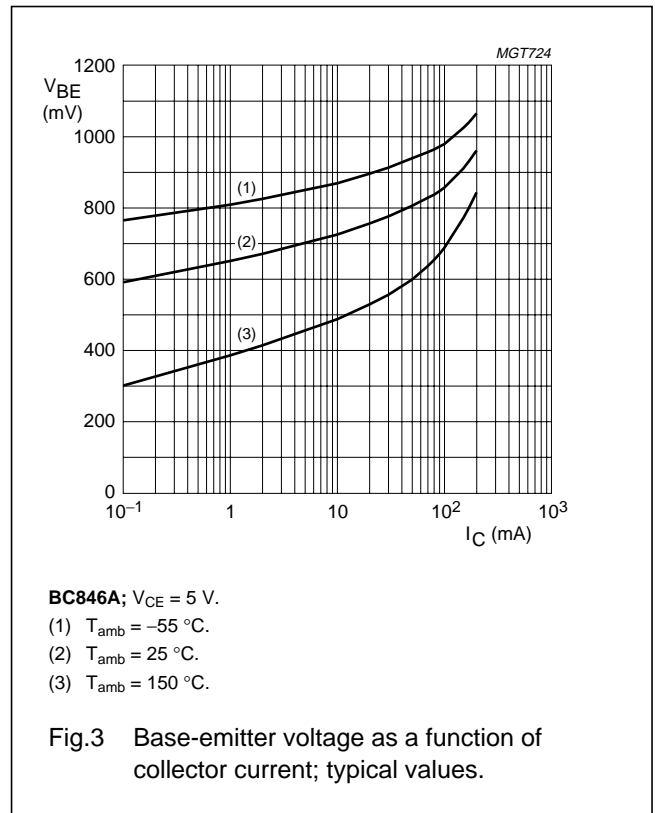
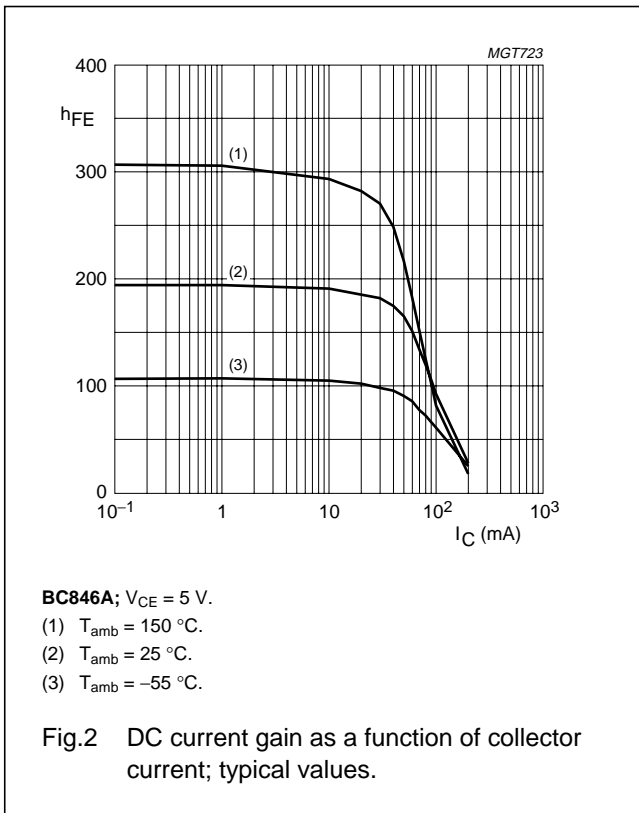

NPN general purpose transistors

BC846; BC847; BC848

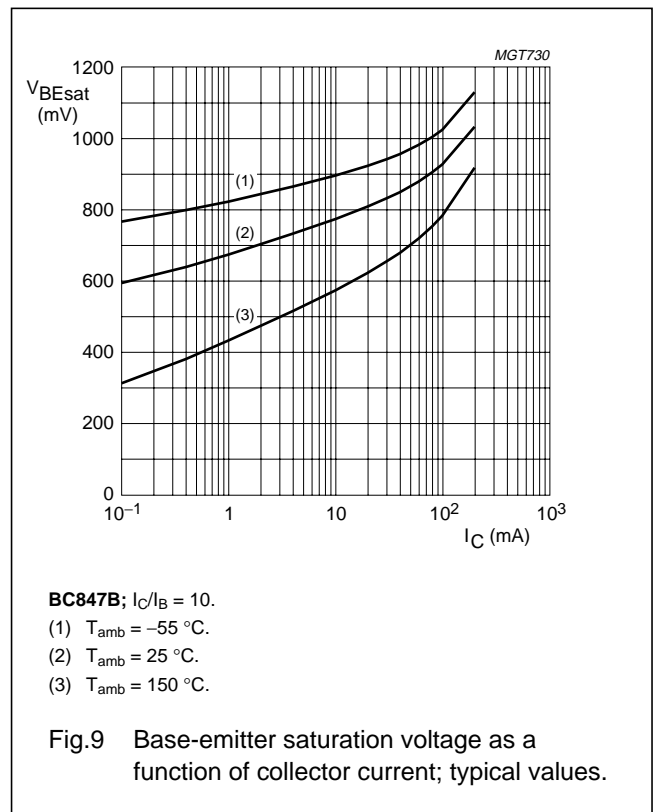
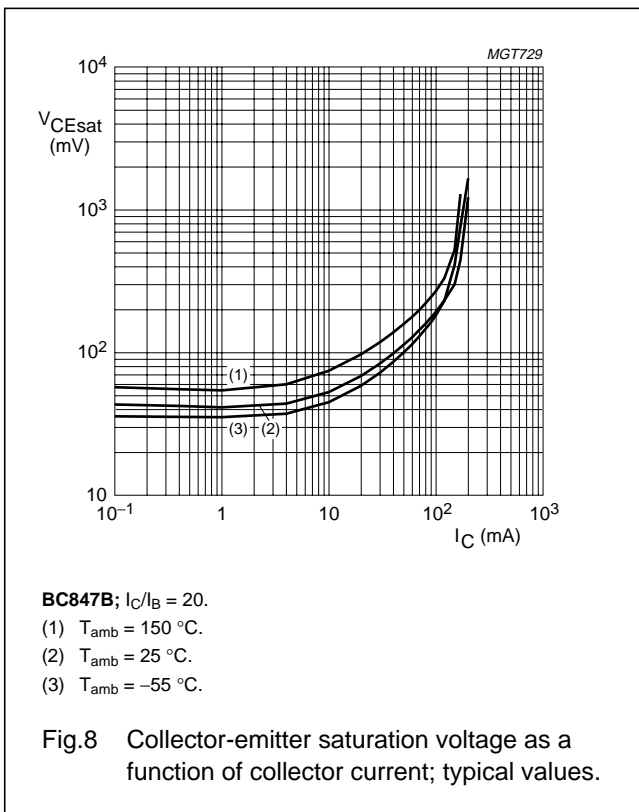
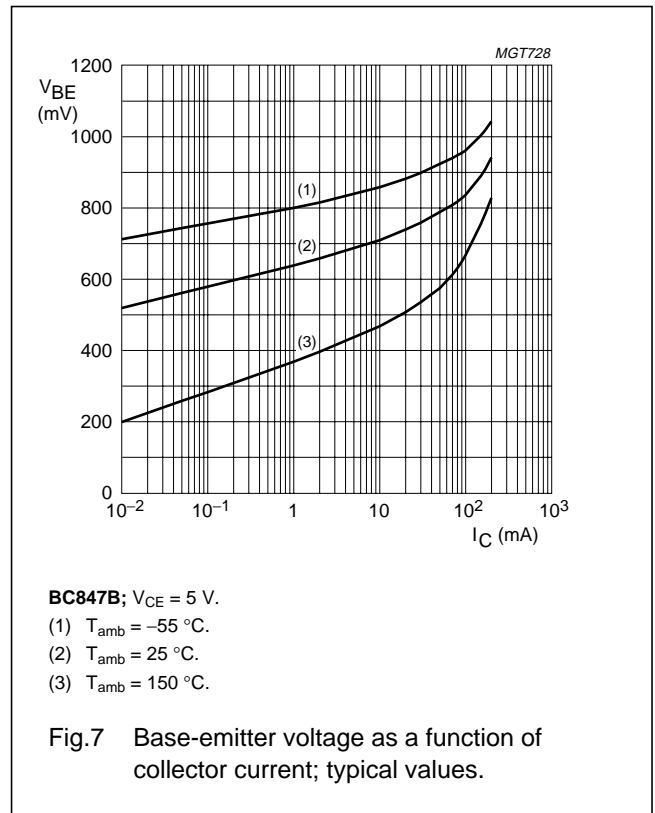
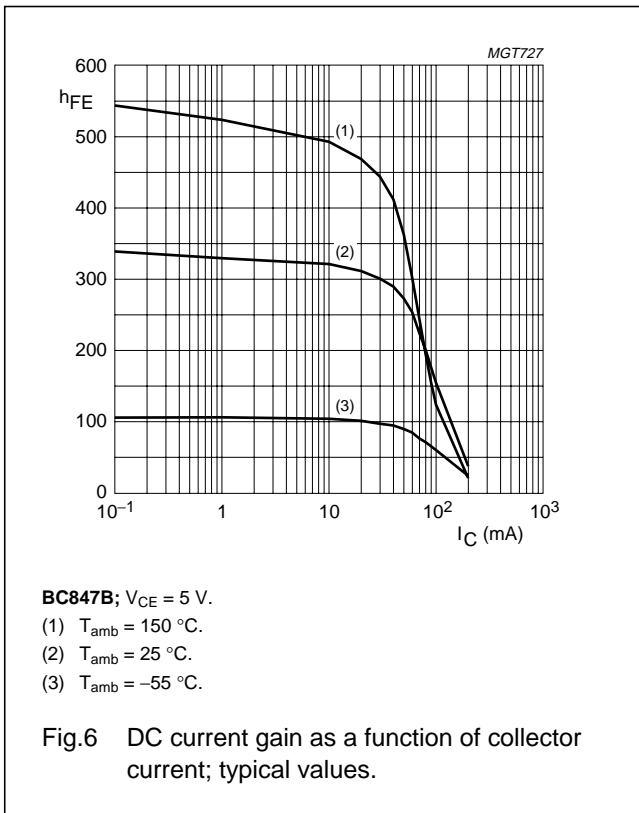

NPN general purpose transistors

BC846; BC847; BC848

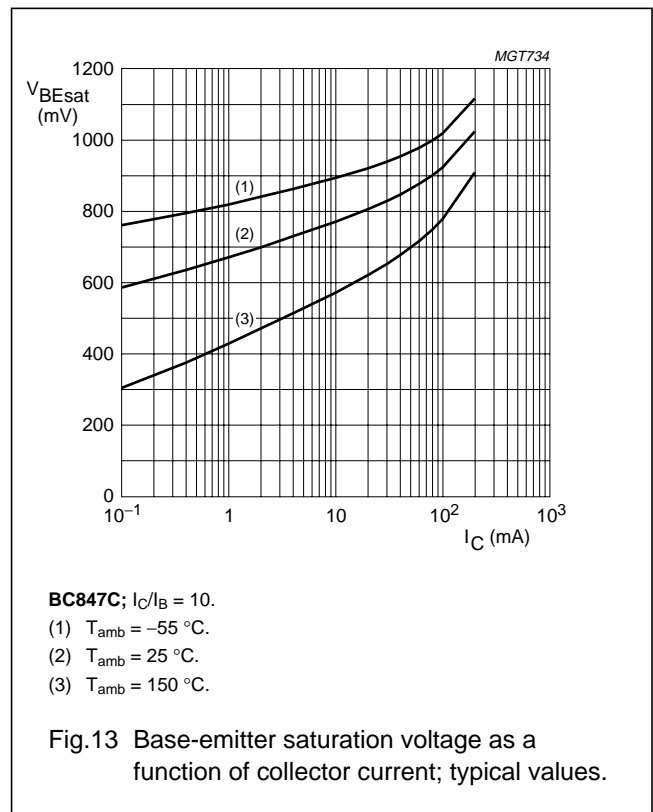
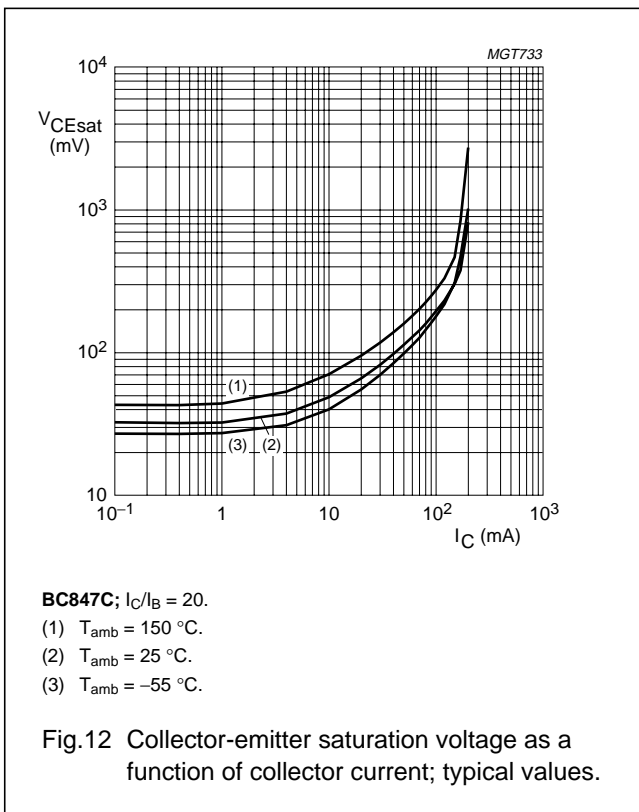
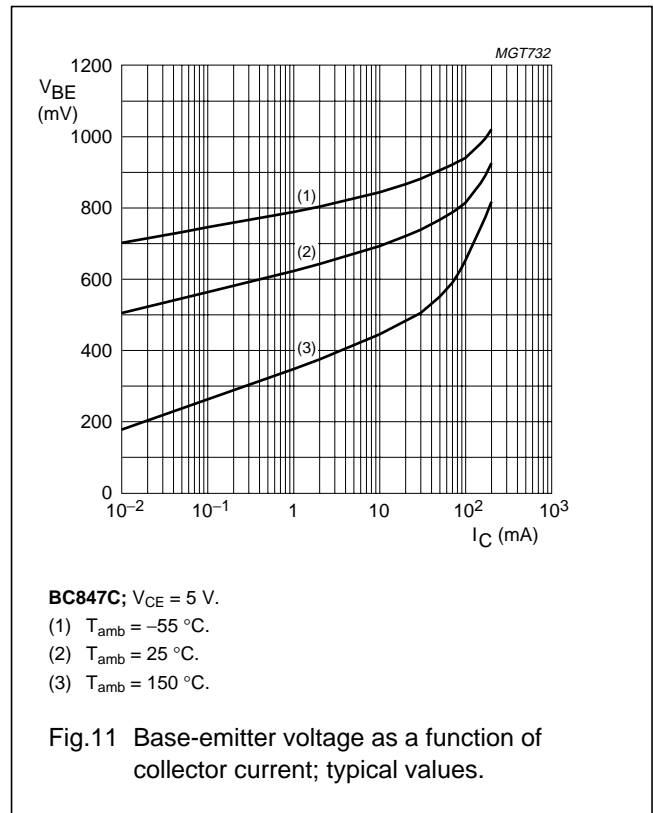
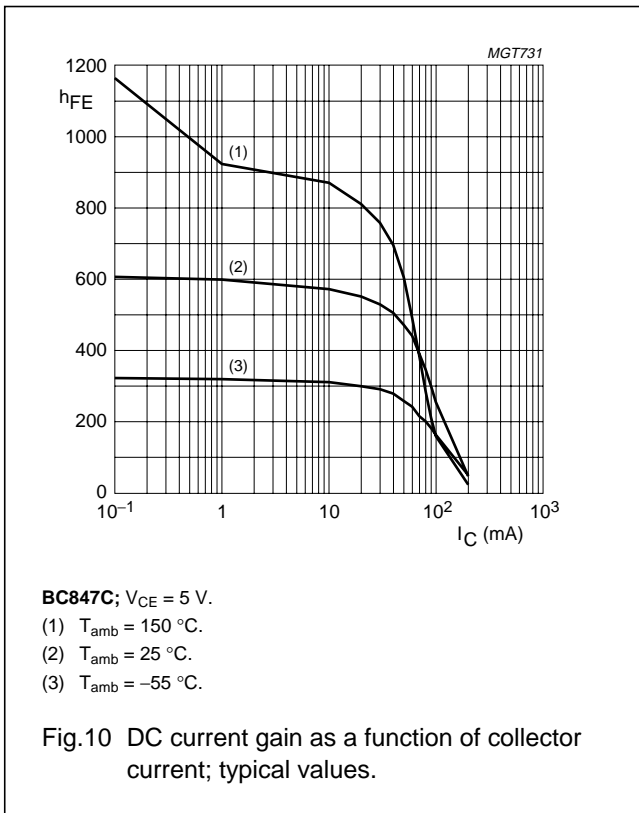

NPN general purpose transistors

BC846; BC847; BC848

PACKAGE OUTLINE

Plastic surface mounted package; 3 leads

SOT23

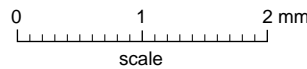
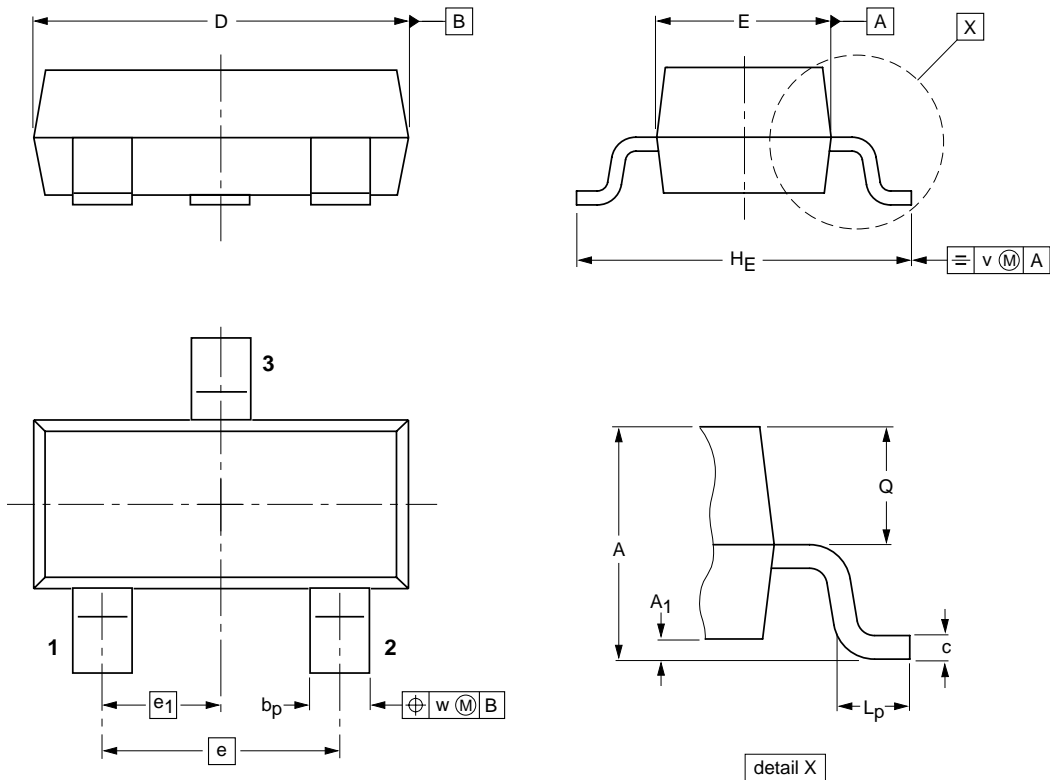

DIMENSIONS (mm are the original dimensions)

UNIT	A	A ₁ max.	b _p	c	D	E	e	e ₁	H _E	L _p	Q	v	w
mm	1.1 0.9	0.1	0.48 0.38	0.15 0.09	3.0 2.8	1.4 1.2	1.9	0.95	2.5 2.1	0.45 0.15	0.55 0.45	0.2	0.1

OUTLINE VERSION	REFERENCES				EUROPEAN PROJECTION	ISSUE DATE
	IEC	JEDEC	EIAJ			
SOT23		TO-236AB				97-02-28- 99-09-13