

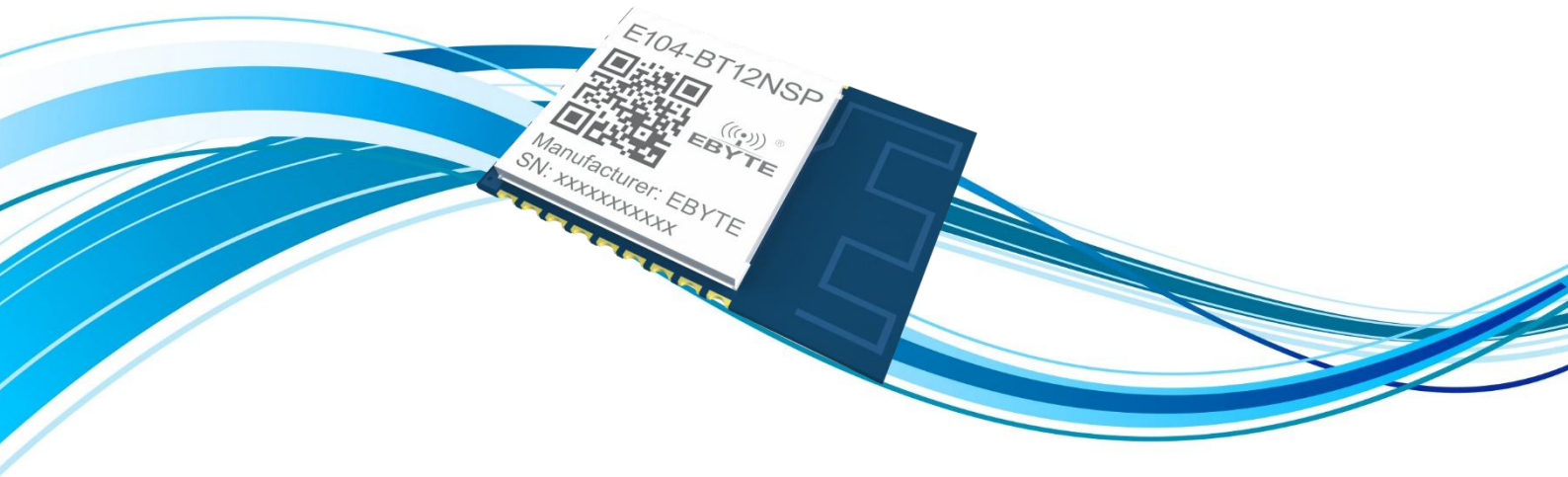

E104-BT12NSP User Manual

TLSR8253F512 Serial Patch SIG Mesh Group Module



CONTENTS

DISCLAIMER.....	3
1. PRODUCT OVERVIEW.....	4
1.1 BRIEF INTRODUCTION.....	4
1.2 FEATURE.....	4
1.3 APPLICATION.....	4
2. TECHNICAL PARAMETERS.....	5
2.1 LIMIT PARAMETER.....	5
2.2 OPERATING PARAMETER.....	5
2.3 DIMENSION AND PIN DEFINITION.....	6
3. BASIC OPERATION.....	7
3.1 HARDWARE DESIGN.....	7
3.2 BASIC CIRCUIT.....	8
4. FUNCTIONAL INTRODUCTION.....	9
4.1 BASIC CONCEPT.....	10
4.1.1 NETKEY.....	10
4.2 DATA FORMAT.....	13
5. SWITCH DIO.....	21
5.1 USE OF SWITCHES.....	21
6. QUICK GET START.....	21
6.1 RESTORE FACTORY SETTINGS RESTORE.....	22
6.2 EQUIPMENT ENTERS THE NET AND CONTROLS THE EQUIPMENT.....	22
6.3 SIG MESSAGES.....	28
6.4 TRANSMISSION OF INFORMATION.....	29
6.5 LOW POWER CONSUMPTION (E104-BT12LSP).....	31
7. FAQ.....	31
7.1 POOR TRANSMISSION RANGE.....	31
7.2 MODULE IS EASY TO DAMAGE.....	32
7.3 THE ERROR RATE IS TOO HIGH.....	32
8. WELDING INSTRUCTION.....	32
8.1 REFLOW WELDING TEMPERATURE.....	32
8.2 BACKFLOW WELDING CURVE.....	33
9. REVISION HISTORY.....	34
ABOUT US.....	34

Disclaimer

EBYTE reserves all rights to this document and the information contained herein. Products, names, logos and designs described herein may in whole or in part be subject to intellectual property rights. Reproduction, use, modification or disclosure to third parties of this document or any part thereof without the express permission of EBYTE is strictly prohibited.

The information contained herein is provided “as is” and EBYTE assumes no liability for the use of the information. No warranty, either express or implied, is given, including but not limited, with respect to the accuracy, correctness, reliability and fitness for a particular purpose of the information. This document may be revised by EBYTE at any time. For most recent documents, visit www.ebyte.com.

Note:

The contents of this manual are subject to change due to product version upgrades or other reasons. Chengdu Ebyte Electronic Technology Co.,Ltd. reserves the right to make changes to the contents of this manual without notice or suggestion. This manual serves only as a user guide and Chengdu Ebyte Electronic Technology Co.,Ltd. endeavours to provide accurate information in this manual, but Chengdu Billionaire Electronics Co., Ltd. does not ensure that the contents are completely error-free and that all statements, information and suggestions in this manual do not constitute any express or implied warranty.

1. Product Overview

1.1 Brief Introduction

E104-BT12SP Bluetooth Mesh self-organizing network module supports Sigmesh V1.0 standard, single network theory can accommodate up to 16,383 nodes. The network information is automatically memorized after the device enters the net, and the network time is completed within 1 second. Mobile phone APP can be used as proxy on any node to realize remote control of Mesh network. It is convenient to broadcast in-network or any fixed point data transmission. The transmission packet can support 60 bytes maximum. Support SIG standard HSL (H:Hue, S:Saturation, L:Lightness) model, one key implementation of lamp control application scene, and support Skycat elves. Suitable for Internet of Things information gathering, large-scale network communication, smart home, etc.

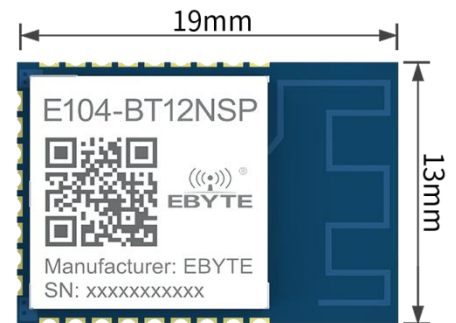

1.2 Feature

- Support TmallGenie.
- Support TmallGenie.
- PCB carrier antenna, 60m maximum open communication distance
- Multi-stage adjustable power at +10 dBm
- serial port baud rate dynamic compatibility
- Radio channels 37, 38, 39.
- Network Cancellable Center Node
- Memory network information, auto-online.
- Over. One second to go.
- Support mobile phone APP access
- Maximum number of nodes in network 16383
- Support for SIG Mesh Generic Model
- Support for SIG MESH HSL Lighting Models
- Support Custom Serial Port Data Transmission Model
- Supports low power consumption (SIG standard low power consumption)
- support crosstalk wake-up

1.3 Application

- smart home, etc.;
- Building automation;
- Luminaires;
- Wireless sensor networks;
- Internet of Things.

2. Technical Parameters

2.1 Limit parameter

Main parameter	Performance		Note
	Min	Max	
Voltage supply [V]	0	3.6	Voltage over 3.6V will cause permanent damage to module
Blocking power [dBm]	-	10	Chances of burn is slim when modules are used in short distance
Operating temperature [°C]	-40	+85	-

2.2 Operating parameter

Main parameter		Performance			Note
		Min	Typ	Max	
Voltage supply [V]		1.9	3.3	3.6	≥3.3 V ensures output power
Communication level [V]			3.3		For 5V TTL, it may be at risk of burning down
Operating temperature [°C]		-40	-	85	-
Frequency [MHz]		2400		2483.5	ISM band
Power consumption	Transmitting current (mA)	-	21	-	Instantaneous power consumption at 10 dBm output
	Receiving current (mA)	-	6.1	-	-
	Turn-off current (μA)	-	13.32	-	-
maximum emitting power [dBm]		-	10	-	-
Receiving sensitivity [dBm]			-96		Air data rate: 1Mbps
Air data rate	GFSK (bps)	125k	1M	2M	Default 1Mbps

Main parameter	Description	Note
Distance	60m	TClear and open, antenna height 2.5 m, airspeed 1 Mbps.
FIFO	60Byte	Single transmission maximum length
Crystal oscillator	24MHz	-
Modulation	GFSK	GFSK
Package	SMD	-
Connector	1.27mm	-
Interface	UART	4800 ~ 230400bps
Size	19*13mm	-
Antenna	PCB	50Ω Impedance

2.3 Dimension and Pin Definition

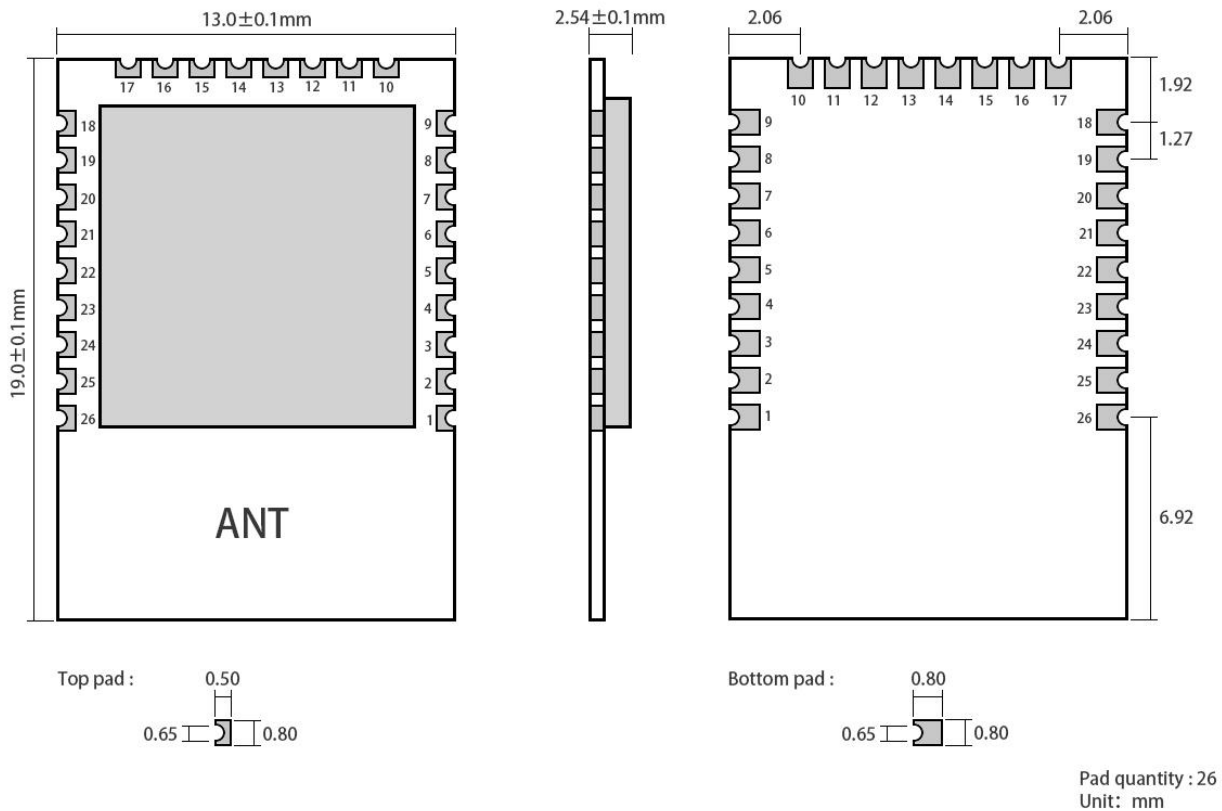

No.	Pin item	Pin direction	Application
1	GND	-	Ground wire, connect to the power reference ground.
2	PWM1	PWM Output	Green light corresponding to SIGMESH HSL
3	PWM2	PWM Output	Red light corresponding to SIGMESH HSL
4	NC	-	-

5	NC	-	-
6	DIO1	Input	Switch input foot, PA0 foot for TLSR8253.
7	DIO2	Input	Switch input foot, PA1 foot for TLSR8253.
8	NC	-	-
9	NC	-	-
10	SWM	-	-
11	SWS	-	-
12	NC	-	-
13	LINK	Output	Network indicator. High level of pilot foot output after network formation.
14	NC	-	-
15	PWM3	PWM Output	Blue light corresponding to SIGMESH HSL model
16	NC	-	-
17	TXD	Output	UART launch boot. Receive user's string of users.
18	RXD	Input	UART receive boot, send to user string
19	VCC	-	Power supply, range 1.9~3.6V (Proposed to increase external ceramic filter capacitance)
20	GND	-	Ground wire, connect to the power reference ground.
21	NC	-	-
22	NC	-	-
23	NC	-	-
24	NC	-	-
25	RST	Input	The chip reset triggers the input foot. It's working at low levels.
26	GND	-	Ground wire, connect to the power reference ground.

3. Basic Operation

3.1 Hardware design

- It is recommended to use DC steady voltage power supply to supply power to this module, the ripple coefficient of power supply is as small as possible, the module needs reliable grounding;
- Note the proper connection of the power supply positive and negative poles. Reconnecting may result in permanent damage to the module.
- Check the power supply to ensure that permanent damage to the module occurs between recommended supply voltages, if exceeded;
- Please check the stability of the power supply. The voltage cannot fluctuate significantly and frequently.
- Please check the stability of the power supply. The voltage cannot fluctuate significantly and frequently.
- When designing power supply circuits for modules, it is often recommended to keep more than 30 percent of the spare, which is advantageous for the whole machine to work steadily over a long period of time.

- Modules should be kept as far away as possible from large parts of electromagnetic interference such as power supply, transformers, high frequency walkers, etc.
- High frequency digital, high frequency analogue and power lines must be avoided under the module. If we have to go under the module, suppose that the module is welded to Top Layer and copper laid on the contact part of the module (all copper laid and well grounded), we must go near the module digital part and follow the wire on Botom Layer.
- Assuming that modules are welded or placed in Top Layers, random paths in Botom Layers or other layers are also wrong, affecting the stray and reception sensitivity of modules to varying degrees;
- Assuming that there is a large amount of electromagnetic interference around the module, the performance of the module can be greatly affected. According to the intensity of the interference, it is recommended to stay away from the module.
- Assuming that there are large electromagnetic interference lines around the module (high frequency digital, high frequency analog, power supply) can also greatly affect the module's performance.
- Keep away from the 2.4 GHz TTL protocol in some physical layers, e.g. USB 3.0;
- The module must not be mounted inside the metal housing, which will greatly weaken the transmission distance.

3.2 Basic Circuit

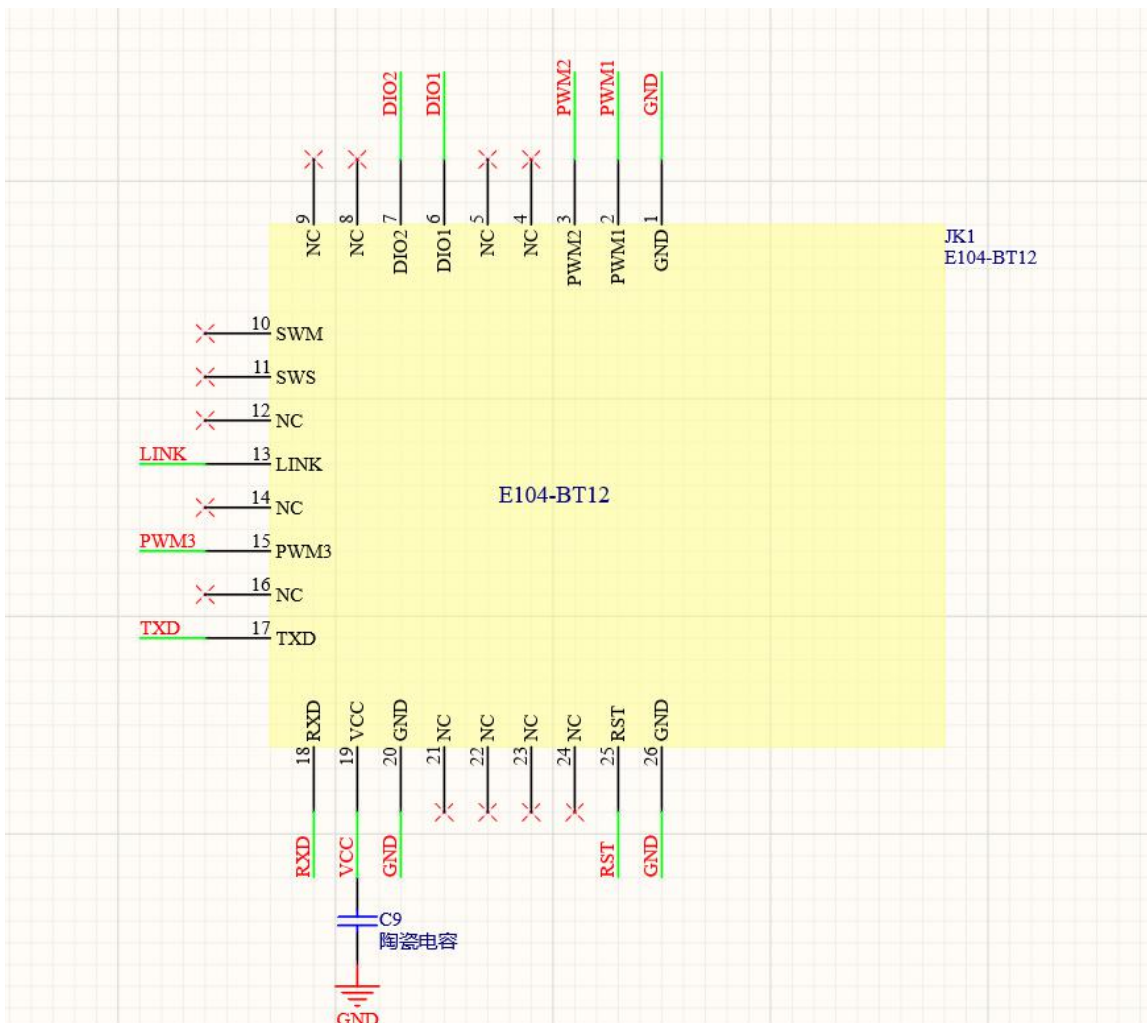

- 1.As shown in the picture,the module can only connect the VCC,GND,TX and RX to perform the communication test.
- 2.PWM1, PWM2, PWM3 corresponding to SIGMESH HSL model;
- 3.DIO1 (PA0 boot corresponding to TLSR8253) and DIO2 (PA1 boot corresponding to TLSR8253) are switch volume input guides that customers can access to and use according to their own needs.
- 4.The low power module can wake up via DIO1, DIO2 and serial port after going to sleep.

4. Functional Introduction

The MESH network architecture is shown below

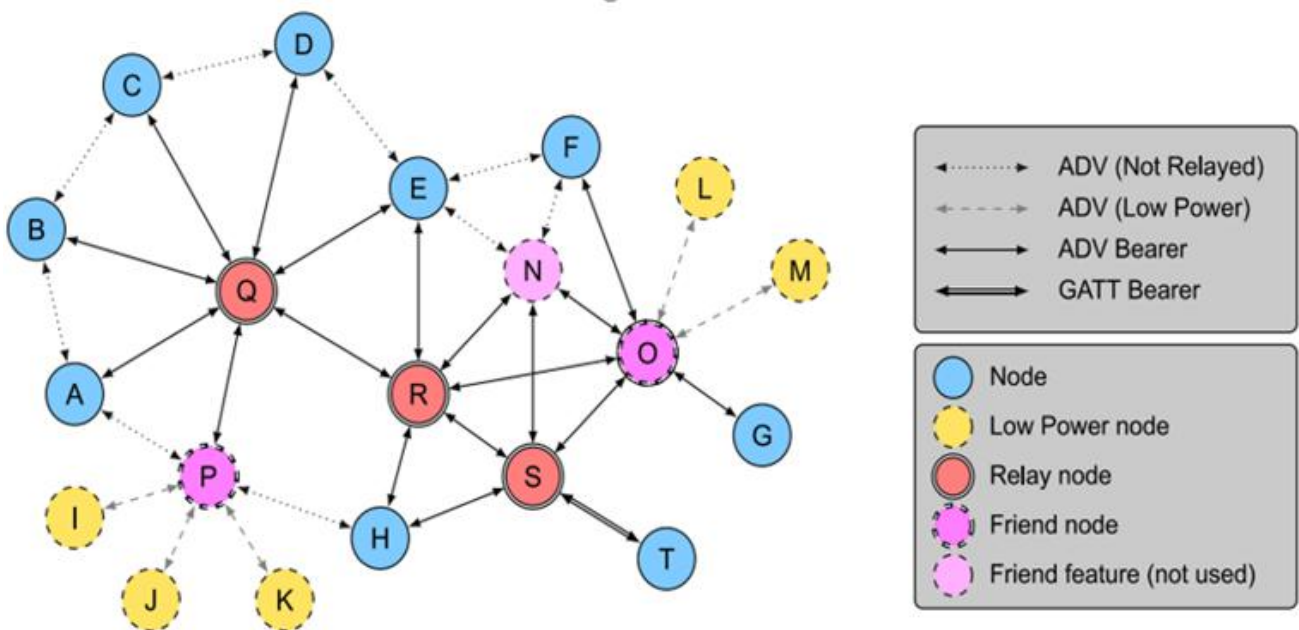

The biggest advantage of this module is that it can relay any data in the network. Any module can be relayed and received at the same time. The module's data signal coverage is about 50 meters. The following is a functional schematic.

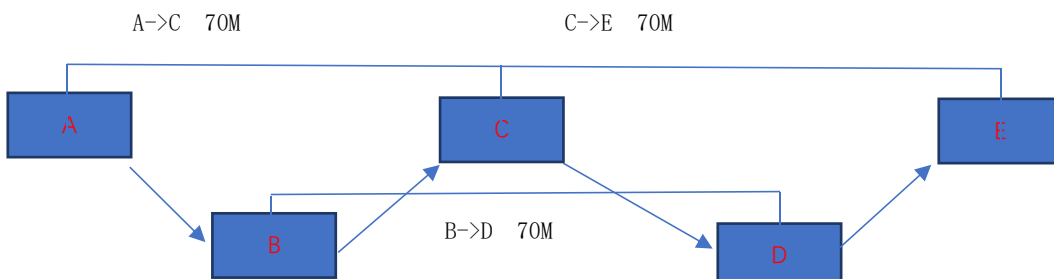

Interpreting the simulation application scene above:

The distance from Module A to Module C is 70 meters, beyond 50 meters of our module's transmission distance, so module A cannot send data directly to module C. If a module B is placed between module A and module C, the data will be relayed by B and then received by module C.

Module A needs to send data to the whole thing. The network, modules B, C, D, E need to receive data from A, then module A will send the data at the broadcast address(0xFFFF).

If module A needs to specify data issuance, All you need to do is write the address of module E at the address in the data format (see instruction format for details). But module E is 140 meters away from module A and cannot communicate the data directly, but as long as these modules are on the same network, the data will be there. The following link reaches module E, where A sends data to B, B to C, C to D, D to E

4.1 Basic Concept

4.1.1 NetKey

Network keys are used to protect network-layer communications. is a key generated by using a random number generator that meets the core specifications. (See Mesh Profile 3.86)

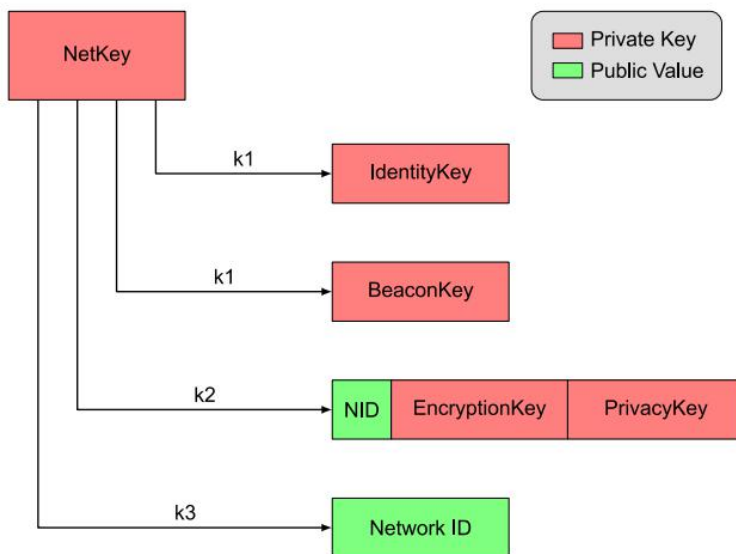

4.1.2 AppKey

Application keys are used to protect the keys of the upper transport layer. Generated using a compatible random number generator. Application Key Identifier (AID) is used to identify application keys. (See Mesh Profile 3.86)

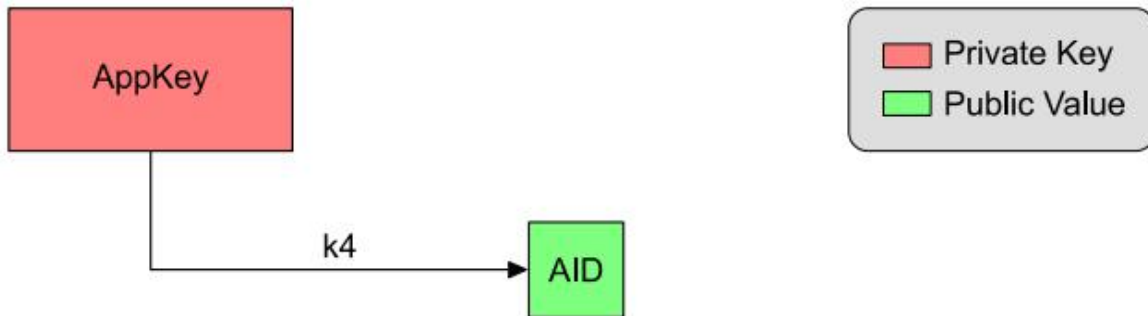

4.1.3 Device Role

The SIG MESH protocols have roles that are Node, Low Power Node, Relay Node, Friend Node, Proxy Node. Related functions are described as follows:

Node: Edge node in the entire Mesh network that has the ability to receive and transmit data but does not have the ability to relay

Low Power Node: Low power nodes that do not have to keep sending or listening to packets on broadcast channels because of the presence of Friend Node. Just check if there is any data on Friend Node.

Relay Node: The core node of the network layer that extends network coverage. After receiving packets sent by other nodes, determine whether forwarding is required based on the determination conditions of the network protocol.

Friend Node: Low power Node can set up a friendly connection with low power Node as a proxy node for low power Node. When data from low power Node is reached, it can be cached waiting for low power Node to query and obtain.

Proxy Node: Proxy node that receives information through a load layer (broadcast load or GATT load) and resends the message through another broadcast load or GATT load. It plays a key role in the non-Mesh low power Bluetooth device becoming a member of Bluetooth Mesh network. The basic purpose of proxy node is to perform load layer conversion. It enables the transition from broadcast load layer to GATT load layer, and vice versa. Therefore, devices that do not support broadcasting can send and receive Bluetooth Mesh messages via a GATT connection. E104-BT12SPN supports proxy node function and enables Mesh network control with mobile phone-side APP (the data compression package contains APP-related SDKs for customer development).

A single device supports only one role. In the EBYTE scheme, our modules support three roles: provision node and mesh node, LPN node, which is the device responsible for networking.

Four ways to connect SIG_mesh:

1. ADV (Not Relayed): Connection not capable of broadcasting. This applies when two nodes send and receive messages to and from each other, but without relay capability, packets cannot be forwarded.
2. ADV (Lower Power): Low-power broadcast connection. Used to send and receive packets between low power Node and Friend Node. On this connection, low power Node initiates a request to establish a connection to Friendship and to query from Friend Node whether there is a packet of its own.

3. ADV Bearer: Broadcast forwarding connection. The two nodes can forward and forward broadcast messages based on broadcasts, and can act as relay. Our product works on this connection.

4. GATT Bearer: Used for nodes that can participate in MESH networks without ADV bearer capabilities, sending and receiving proxy PDUs over GATT connections via proxy protocol with other nodes.

The types of devices that our company supports are provision and mesh, IPN.

Provision node: A special Node node that initiates the entire network. Also called Gateway. It adds unstructured devices to the Mesh network. The Provision node provides provision data to the unallocated device, including netkey, appkey, and the unicast address corresponding to each of the devices' elements.

Mesh Node: Our Mesh node is a combination of four characters: Node, Relay Node, Friend Node and Proxy Node. convenient and quick to use.

4.1.3.1 Moule

There are many models in SIG MESH. Our E104-BT10 module has three addresses. Each one can be bound to more than one model. HSL's model has three addresses because it needs to control three things: brightness, saturation, and color temperature.

Model name	Model ID		
Config Server	0000	Master Address	
Health Server	0002		
Health Client	0003		
Generic OnOff Server	1000		
Generic OnOff Client	1001		
Generic Level Server	1002		
Generic Level Client	1003		
Generic Default Transition Time Server	1004		
Generic Default Transition Time Client	1005		
Light Lightness Server	1300		
Light Lightness Setup Server	1301		
Light Lightness Client	1302		
Light HSL Server	1307		
Light HSL Setup Server	1308		
Light HSL Hue Server	130A		
Light HSL Saturation Server	130B		
Light HSL Client	1309		
VENDOR MODEL (pass-throug model ID)	0001A8		
Generic OnOff Server	1000		Master Address+1
Generic OnOff Client	1001		
Generic Level Server	1002		
Generic Level Client	1003		

4.1.3.2 Unicast,Element

An address corresponds to an element from the Model introduction above. We can call it an elemental address. It is the unique address assigned to a Node node by a PROVISION device during a PROVISION process. Each Node device in the same Mesh network may have multiple addresses.E104-BT12USP is a Provision device and E104-BT12NSP is a Node device.

Introduction to Use:

4.2 Data Format

All data from module serial port interactions, including parameter configuration, network control, and data transmission, meet the following format requirements.Any other data will be deemed invalid and the module will not respond.The parameter configuration is used for the current module's parameter configuration, SIG messages are standard Mesh control messages defined for SIG, and transmission messages are hundreds of millions of custom data transmission messages.

Length (1byte HEX)	Payload (N byte HEX)
N	Parameter configuration SIG Message Pass-through Message

4.2.1 Parameter Configuration

Configuration data is used for reading and writing module parameter information and for device access operations in the following format:

	Directive (1 byte)	Operational code (1 byte)	Data (N byte)
Send	0xC0	0~255	Request data
Receive	0x40	0~255	Response data

Instructions: Proper configuration operation gives corresponding response data. If the configuration error returns the error code, the following:

Error code	Explanation
0x0D	invalid parameter
0x0E	Parameter length error
0x0F	error instruction

4.2.1.1 Get the current network address and status of the device

Network keys are used for network IDs assigned by provisers during network formation in the following format.

	Operational code	Parameter
Request	0x00	

Respond	0x40	06 40 00 data
Example	Request : 02 C0 00 Respond : 06 40 00 DATA[3]	
Description: This instruction is only applicable to E104-BT12SP-L, E104-BT12SP-N to obtain network addresses and configure networks DATA analysis Unorganized network: DATA[0] =0x00, DATA[2],DATA[3]0 Network : DATA[0] =0x01, DATA[2],DATA [3] is the module network address.		

4.2.1.2 Baud Settings

	Operational code	Parameter
Request	0x01	Baud rate serial number to be set (range 0x00~0x07)
Respond	0x01	Returns the current baud rate serial number.
Example	Order	Baud rate specification
	03 C0 01 xx	Xx represents the baud rate label to be set (0x00~0x07) 00 : 230400 01 : 128000 02 : 115200 03 : 76800 04 : 57600 05 : 19200 06 : 9600 07 : 4800
Note : This instruction be suitable for operation of e104-BT112-L and e104-BT12SP-N Example: 03 C0 0E 02, Modification successfully returns 03400E02 if parameter is out of range returns 034000010D		

4.2.1.3 Baud read

	Operational code	Parameter	
Request	0x02	None	
Respond	0x02	Returns the serial number of the set baud rate	
Example	Order	Return	Explanation
	02 C0 02	03 40 02 xx	xx represents the baud rate number 00 : 230400 01 : 128000 02 : 115200

			03 : 76800 04 : 57600 05 : 19200 06 : 9600 07 : 4800
Note: This instruction is applicable to E104-BT12SP-L and E104-BT12SP-N configuration operation.			

4.2.1.4 Power Settings

	Operational code	Parameter	
Request	0x03	Power number to be set (range 0x00~0x0C)	
Respond	0x03	Return to the set power number	
Example	Order	Explanation	
	03 C0 03 xx	Xx represents the baud rate label to be set (0x00~0x0A) 00 : +10dBm 01 : +8dBm 02 : +6dBm 03 : +4dBm 04 : +2dBm 05 : 0dBm 06 : -2dBm 07 : -4dBm 08 : -6dBm 09 : -8dBm 0A : -10dBm 0B: -25dBm 0C: -30dBm	
Note : This instruction is applicable to E104-BT12SP-L and E104-BT12SP-N configuration operation.			

4.2.1.5 Power Reading

	Operational code	Parameter	
Request	0x04	None	
Respond	0x04	Returns the serial number of the power currently in use	
Example	Order	Return	Explanation
	02 C0 04	03 40 04 xx	xx represents power number 00 : +10dBm 01 : +8dBm 02 : +6dBm

			03 : +4dBm 04 : +2dBm 05 : 0dBm 06 : -2dBm 07 : -4dBm 08 : -6dBm 09 : -8dBm 0A : -10dBm 0B: -25dBm 0C: -30dBm
<p>Note: This instruction is applicable to E104-BT12SP-L and E104-BT12SP-N configuration operation.</p>			

4.2.1.6 Rebooting of Equipment

	Operational code	Parameter
Request	0x05	None
Respond	0x05	Returns operational status value
Example	Request : 02 C0 05 Respond : 03 40 05 00	
<p>Note: This instruction is applicable to E104-BT12SP-L and E104-BT12SP-N configuration operation. Status value 00 indicates success.</p>		

4.2.1.7 Restore factory settings restore

	Operational code	Parameter
Request	0x06	None
Respond	0x06	None
Example	Request: 02 C0 06 Respond: 03 43 15 00	
<p>Note : This instruction is applicable to E104-BT12SP-L and E104-BT12SP-N configuration operation. Status value 00 indicates success.</p>		

4.2.1.8 MAC Read

	Operational code	Parameter
Request	0x07	None

Respond	0x07	Returns the device's current MAC address
Example	Request : 02 C0 07 Respond : 08 40 11 MAC[6]	
Note :		
This instruction is applicable to E104-BT12SP-L and E104-BT12SP-N configuration operation.		

4.2.1.9 Obtaining Software Version Number

	Operation al code	Parameter
Request	0x08	None
Respond	0x08	software version number
Example	Request : 02 C0 08 Respond : 04 40 16 10 00	
Note :		
This instruction is applicable to E104-BT12SP-L and E104-BT12SP-N configuration operation. Software version number is unique.		

4.2.1.10 Equipment triad information

	Operation al code	Parameter
Request	0x09	None
Respond	0x09	Setup triad information
Example	Request : 1C C0 09 DATA[26] Respond : 1D 40 09 DATA[26]	
Note :		
This instruction be for E104-BT12SP-N configuration operation only DATA[0`3] : pocet_id DATA[4`9] : pocet_mac DATA[10-26] : pocet_sec		
The application method for this triad and the instruction usage method are shown in the "Apply Triad to Ali and Set Up Device Information " document		

4.2.1.12 Set LPN to Time Out and Return to Sleep

	Operation al code	Parameter
Request	0x0B	None
Respond	0x0B	Set time-out sleepout.
Example	Request : 04 C0 0B TIME Respond : 05 40 0B TIME	
<p>Note : Default 5000 ms</p> <p>This instruction be for e104-BT12SP-L configuration operation only</p> <p>TIME:16-cimal segment mode</p> <p>Column: Set 5000 ms, convert 5000 to 16-digit value 1388. When you set it, you need to write 8813.</p> <p>04 C0 0B 8813</p>		

4.2.1.13 Timeout after Reading LPN External Wake-up

	Operation al code	Parameter
Request	0x0C	None
Respond	0x0C	Set time-out sleepout.
Example	Request: 04 C0 0C TIME Respond: 05 40 0C TIME	
<p>Note:</p> <p>This instruction be for E104-BT12SP-L configuration operation only</p> <p>TIME:16-cimal segment mode</p> <p>Column: Reading values 8813, 8813 is small-end mode. Actual value is 1388, converted to decimal value of 5000</p>		

4.2.1.14 Setting up LPN polling friend time

	Operation al code	Parameter
Request	0x0D	None
Respond	0x0D	Set time-out sleepout.
Example	Request : 04 C0 0D TIME Respond : 05 40 0D TIME	
<p>Note : Default 2000</p> <p>This instruction be for E104-BT12SP-L configuration operation only</p> <p>TIME:16-cimal segment mode</p> <p>Column: Set 5000 ms, convert 5000 to 16-digit value 1388. When you set it, you need to write 8813.</p>		

04 C0 0D 8813

4.2.1.15 Reading LPN polling friend time

	Operation al code	Parameter
Request	0x0E	None
Respond	0x0E	Set time-out sleepout.
Example	Request : 04 C0 0E Respond : 05 40 0E TIME	
Note : This instruction be for E104-BT12SP-L configuration operation only TIME:16-cimal segment mode Column: If the reading value is 8813, 8813 is small-end mode, the actual value is 1388, converted to decimal value is 5000		

4.2.1.16 Set LPN to Sleep Time without Networking

	Operation al code	Parameter
Request	0x0F	None
Respond	0x0F	Set time-out sleepout.
Example	Request : 04 C0 0F TIME Respond : 05 40 0F TIME	
Note : Default 10000 This instruction be for E104-BT12SP-L configuration operation only TIME:16-cimal segment mode Column: Set 5000 ms, convert 5000 to 16-digit value 1388. When you set it, you need to write 8813. 04 C0 0F 8813		

4.2.1.17 Reading LPN Unstructured Networks to Sleep Time

	Operation al code	Parameter
Request	0x10	None
Respond	0x10	Set time-out sleepout.
Example	Request : 04 C0 10 Respond : 05 40 10 TIME	
Note : This instruction be for E104-BT12SP-L configuration operation only		

TIME:16-cimal segment mode
 Column: If the reading value is 8813, 8813 is small-end mode, the actual value is 1388, converted to decimal value is 5000

4.2.2 SIG Messages

The E104-BT12 module supports SIG Generic and Lighting HSL model control (see Mesh Profile and Mesh Model introduction for relevant SIG message definitions).The SIG message format is as follows:

Send			
Order (1byte)	Target address (2 bytes)	Sig mesh message	
0xC1	Primary address of Target device	Request	
Receive			
Order (1byte)	Target address (2 bytes)	Original address (2 bytes)	Sig mesh message
0x41	Primary address of Target device	Source device master address	Respond

For example: 1.Generic onoff control of Generic model:

Control the device whose main address is 0004, output high level without delay	
Request	09 C1 0004 8202 01000000
Respond	08 41 0004 0001 8204 01
Control the device whose main address is 0004, output low level without delay	
Request	09 C1 0004 8202 00000000
Respond	08 41 0004 0001 8204 00

2. Transparent transmission of information

E104-BT12 supports transparent transmission of user data. The maximum length of the serial port sub-packet is 60 bytes (the maximum payload of a single packet in the bottom layer of the mesh is 8 bytes, and data larger than 8 bytes will be automatically sub-packed and sent, due to the efficiency of the entire mesh network during the sub-packet sending process. Not high, it is recommended to limit the data sent in a single time to less than 8 bytes), the data format is as follows:

Send			
Order (1byte)	Target address (2 bytes)	Data	
0xC2	Primary address of Target device	Valid data	
Receive			
Order (1byte)	Target address (2 bytes)	Original address (2 bytes)	Data
0x42	Primary address of Target device	Source device master address	Valid data

For example: Device 0001 sends the hexadecimal data of "00112233445566778899" to device 0004

Sender	0D C2 0004 00112233445566778899
Receiver	0F 42 0004 0001 00112233445566778899

5. Switch DIO

E104-BT12 switches for furniture-only applications. Each module of our E104-BT12 supports two elements. There are many modules under one element. The reference model is shown below.

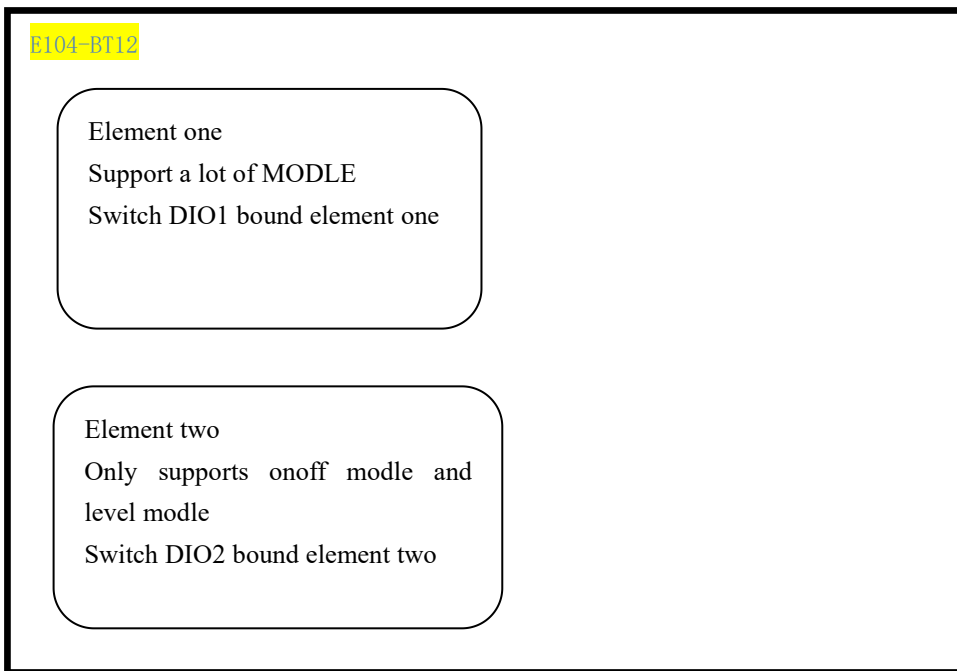

5.1 Use of switches

When E104-BT12 is networked, you need to group the address of the element under the current device.

When I have three devices: A and B and C, use danglog to network them all. Note that all devices that are not low power nodes are automatically grouped to C000. It is best to remove C000 when you verify switch function.

Then B device element is then assigned to C002 and C device to C003.

If the two switches DIO1 through device A are connected high, then device B lights up, DIO.If one is low, then device B lights go out.

Switch DIO2 to low C device lights out, DIO2 to high, C device lights on.

6. Quick get start

This chapter introduces how E104-BT12SPs form networks quickly and how to control network message transmission and delivery.

6.1 Restore factory settings restore

Send the following instruction 02 C006 and you'll receive a return 0343 0600, E104-BT12NSP in the same format as the E104-BT12LSP instruction.

Baud rate:115200, other8N1, do not return to change lanes.

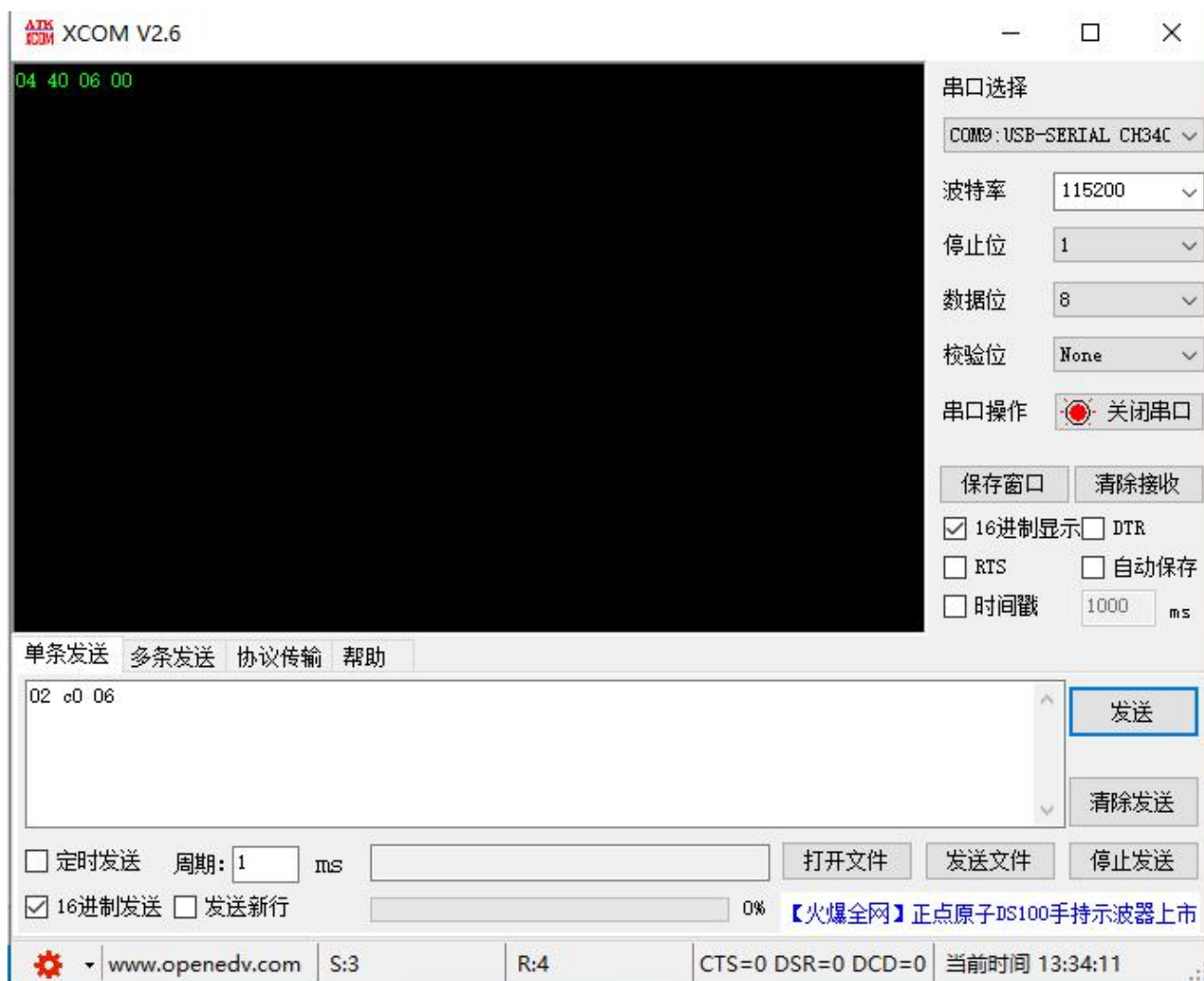

6.2 Equipment enters the net and controls the equipment

Note: All E104-BT12SP-N needs to have Ali triad information before use. See Documentation "Apply Triad to Ali and Set Up Device Information "

6.2.1 Using Tmallgenie in the Internet

Voice enters the net, directs the voice command "Tmallgenie, Find Smart Devices" and then acts on Tmallgenie's cue.

6.2.1.1 Switching Using Tmallgenie

Use voice command Tmallgenie to turn on or off the lights.

6.2.2 Using Uploader + Usb Dangler

6.2.2.1 Networking and Lighting Control

See the "Tutorial on Use of Tutorials" for details.

6.2.3 Mobile phone APP access and control devices

6.2.3.1 Access to the network

1. Open the APP and click this plus sign

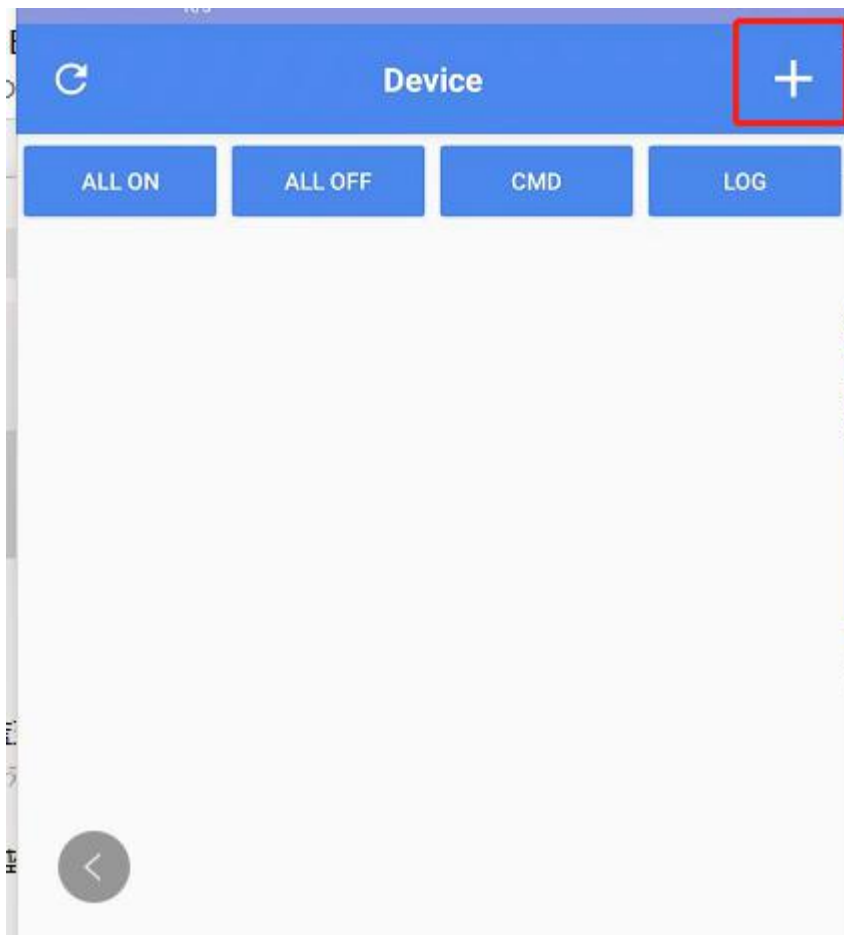

1. If there is an unstructured network around, the following diagrams will appear in sequence.

Device Scan



adr: 0x0002 -
uuid:A8017109A16A004C4A
486C1418020000 - mac:
18:14:6C:48:4A:4C

Provisioning



Device Scan



adr: 0x0002 -
uuid:A8017109A16A004C4A
486C1418020000 - mac:
18:14:6C:48:4A:4C

Key Binding



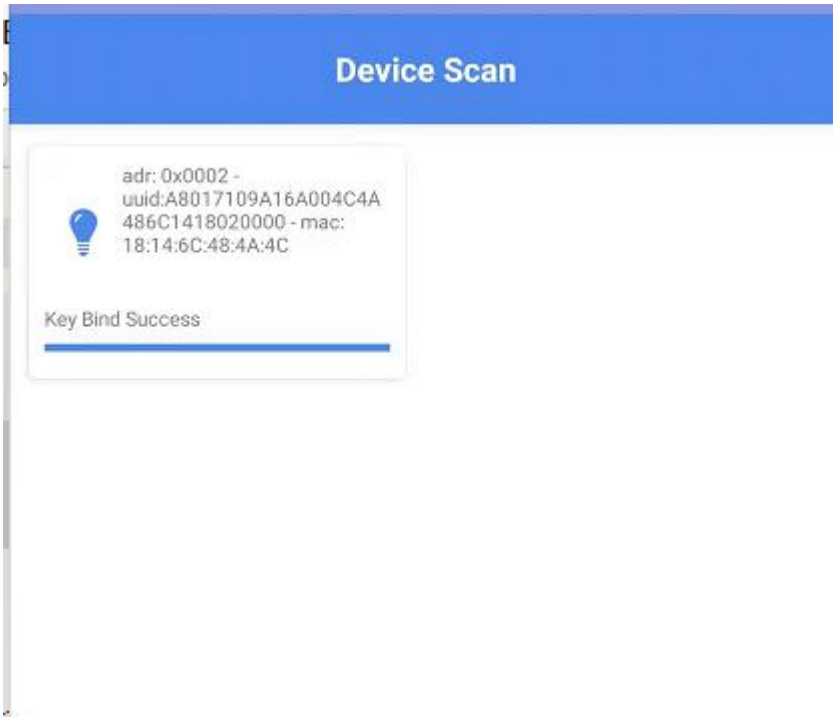

2. When the last drawing in the previous step returns to the APP home page, you can see a lamp, click on the lamp and see that the device's LED is switching on and off according to your operation.

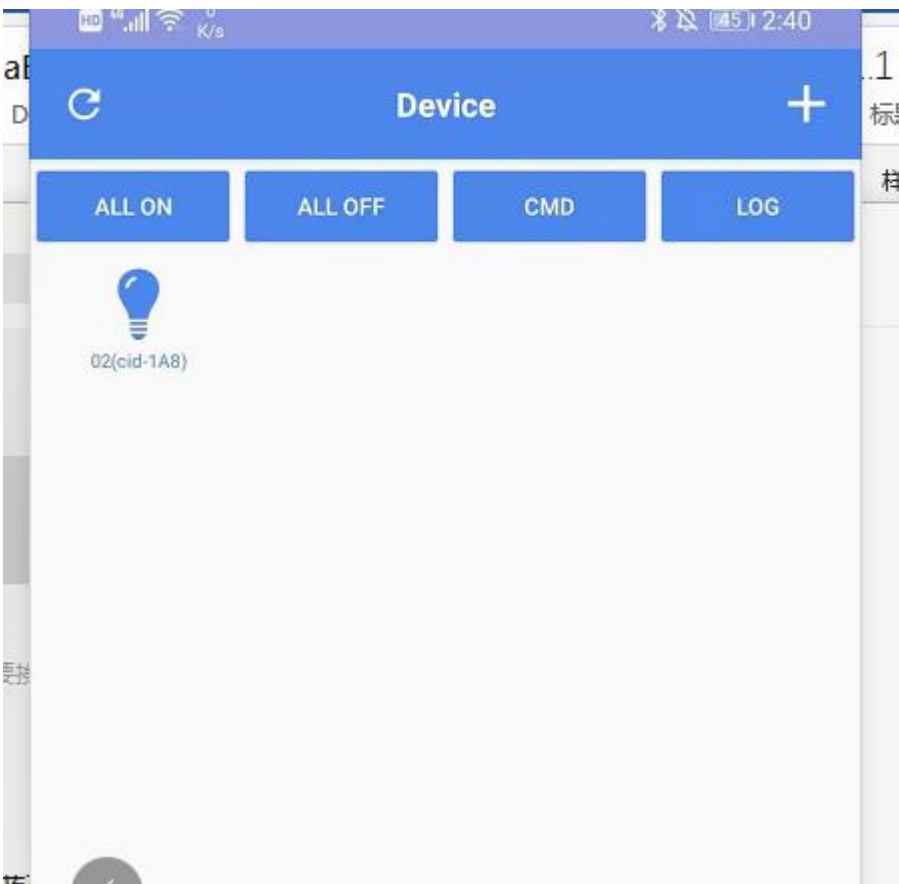

4. When you press the length of the lamp, it will appear on the page as shown below, while sliding colored circles will change the color of the lamp to the color you to the color you want.

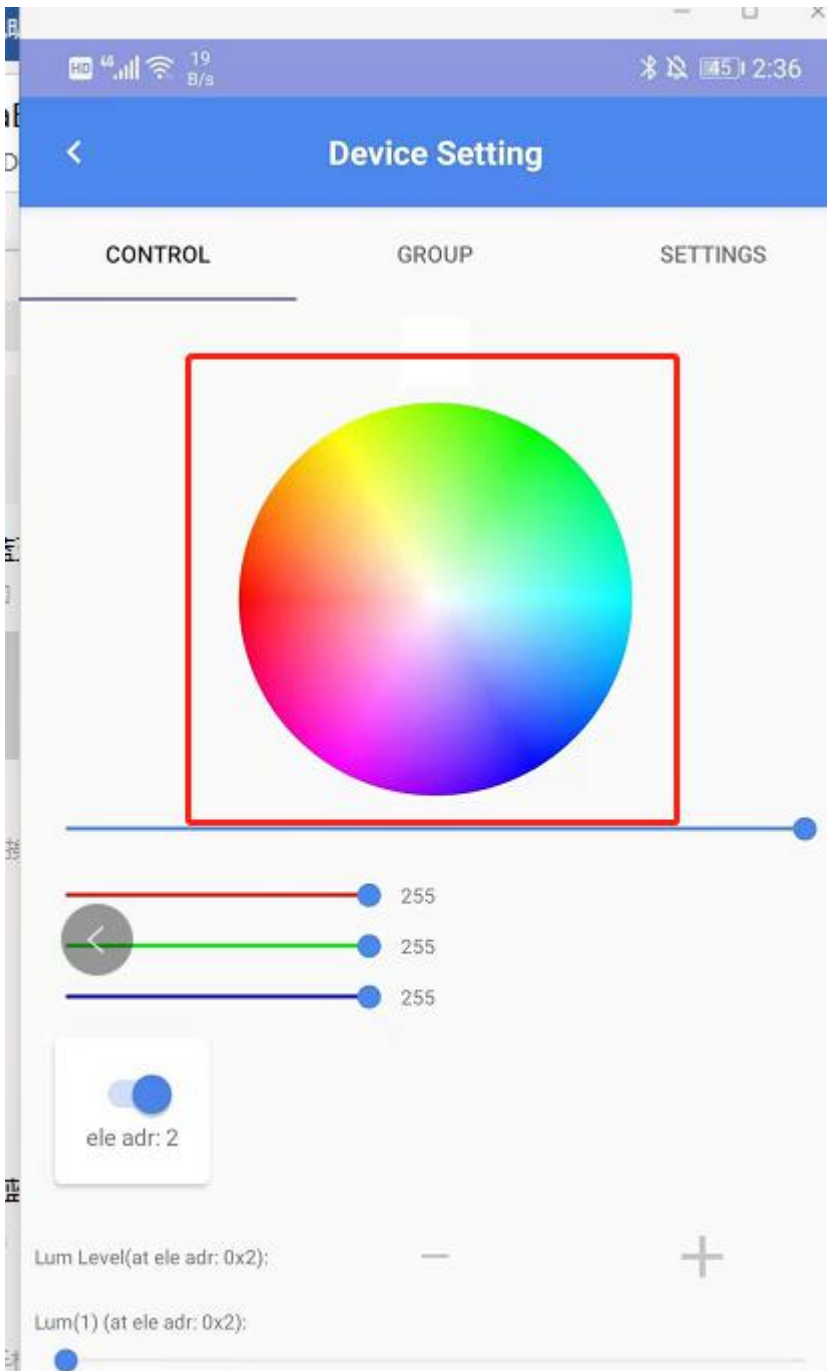

6.2.3.2 Publishing and Subscribing (Grouping)

1. Pressing multiple devices in turn into GROUP and then ticking the options on this page represents that you are dividing your devices into this group

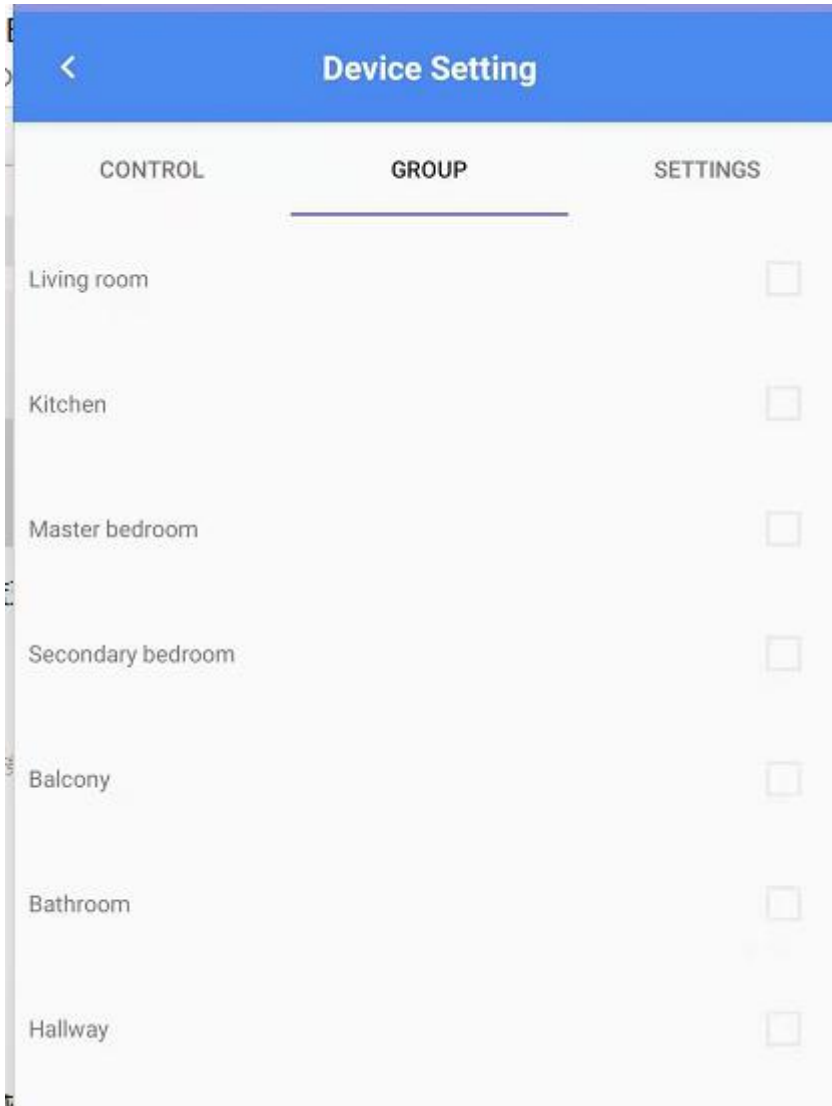

2. When grouping is successful, group control can be carried out through GROUP on the mobile phone homepage

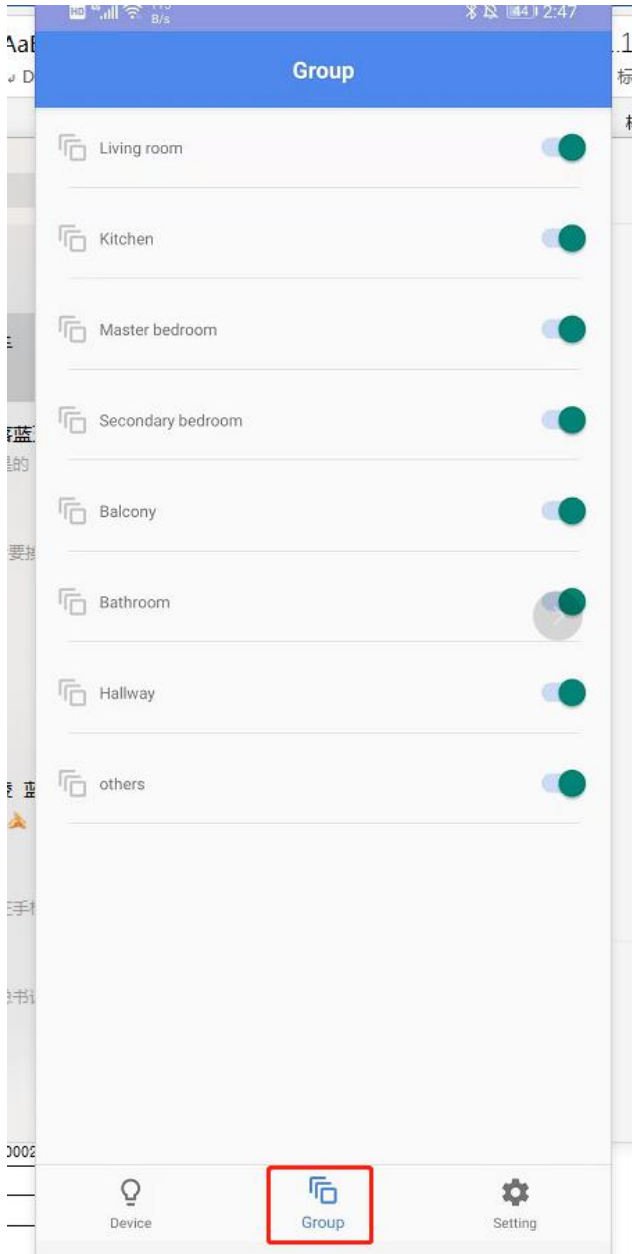

6.3 SIG Messages

E104-BT12SP Sending Generic onoff Instruction Control Network Equipment

If the Target address is the group address, the device in the current group will respond
(See Mesh Model 3.2.1.2 Generic OnOff Set for more information.)

Send	09 C1 0002 8202 01000000
Response	08 41 0002 0001 8204 01

E104-BT12SP sends the light off command (generic onoff command) command to control the network equipment
(See Mesh Model 3.2.1.2 Generic OnOff Set for more information.)

Send	09 C1 0002 8202 00000000
------	--------------------------

Response	08 41 0002 0001 8204 00
----------	-------------------------

6.4 Transmission of information

Group addresses cannot be obtained using the Tmallgenie group network; data can only be transmitted via unicast addresses

Device 0002 broadcasts hexadecimal data for "8202000"

Writing the Target address as FFFF is broadcasting where all devices, including their own, receive data.

Sender	09 C2 ffff 8202 01 00 00 00
Receiver	0C 42 02 00 FF FF 82 02 01 00 00 00

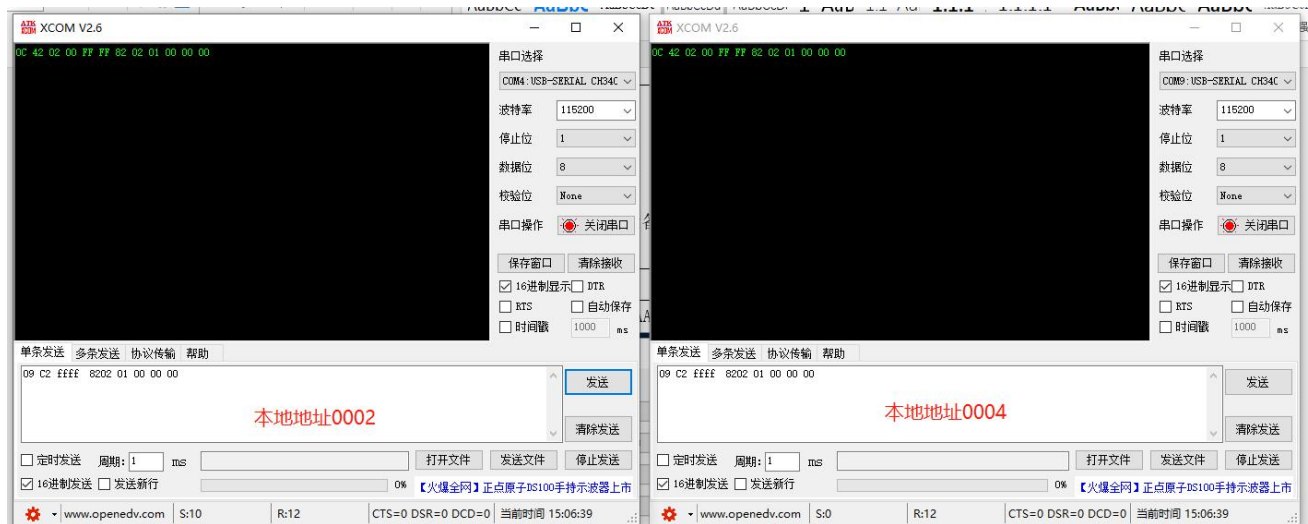

6.4.1 Fixed-point data transmission

For example: Device 0002 sends hexadecimal data of "82 02 01 00 00 00" to device 0004

Sender	09 C2 0004 8202 01 00 00 00
Receiver	0C 42 02 00 04 00 82 02 01 00 00 00

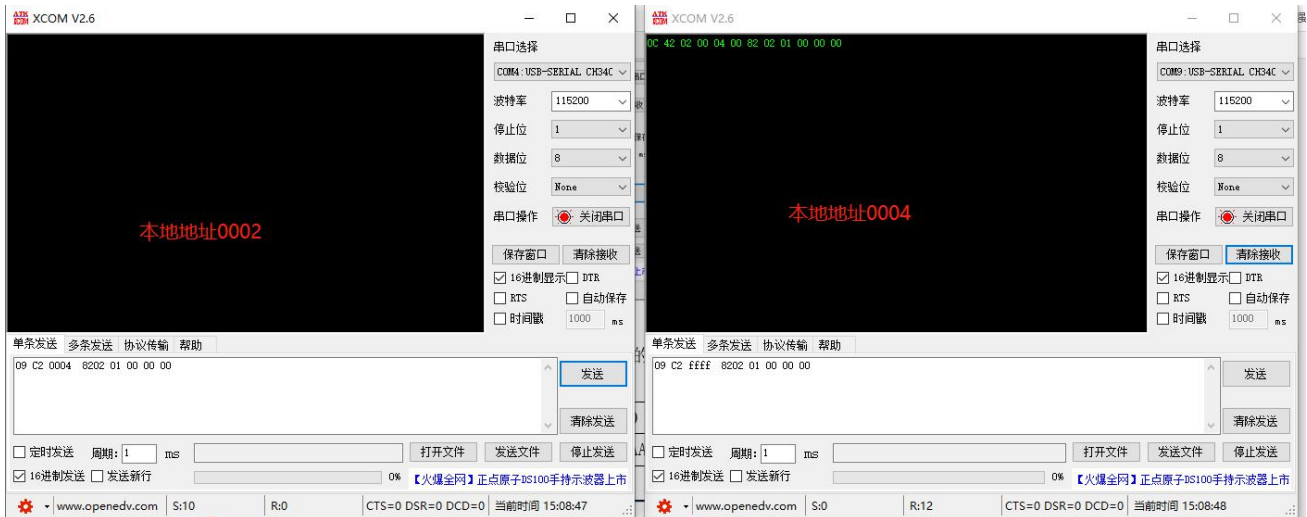

6.4.2 Group address transmission data

For example: Device 0002 sends hexadecimal data for "82 0200 000" to this group of device C001

Sender	09 C2 0004 8202 01 00 00 00
Receiver	0C 42 02 00 04 00 82 02 01 00 00 00

6.4.2.1 Acquisition of Group Addresses using APP

Add 1 down to the address shown below.

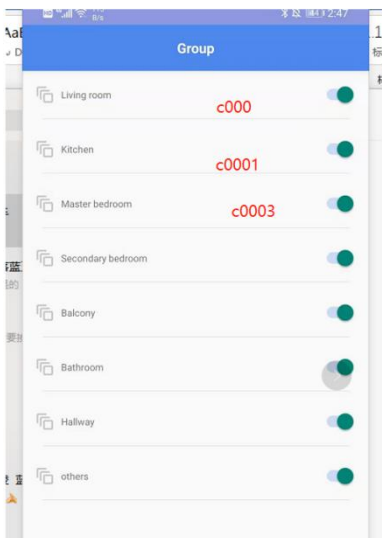

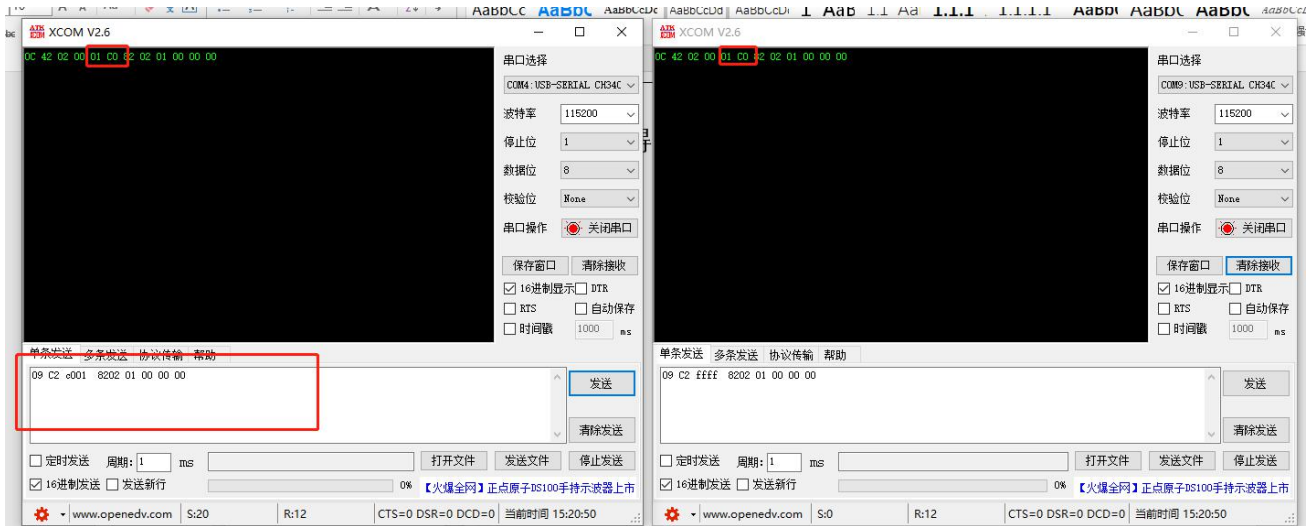

6.5 Low Power Consumption (E104-BT12LSP)

Use low power method consistent with normal N nodes, but only use APP and USB danglo network, data transmission method consistent

The only difference be that you need to group vindor mode and lightness medium in the same group number when you use the group address to transmit data to an LPN

For example: e8 ff 00 00 00 02 01 02 00 80 1b 02 00 01 c0 18 0A 00 00

e8 ff	00 00	00 00	02 01	02 00	80 1b	02 00	01 c0	180A	00 00
Cmd	fixed field	fix	fix	Target address	Sig op	Element address	Group address	ModleID	fix

7. FAQ

7.1 Poor transmission range

- When there is a linear communication barrier, the communication distance decays accordingly.
- Temperature, humidity and same frequency interference can lead to higher packet drop rate;
- The ground absorbs and reflects radio waves, and the test results are poor near the ground.
- Sea water absorbs radio waves so much that the beach test results.poor;

- Metal objects near antennas, or placed in metal shells, attenuated signals.very serious;
- Incorrect power register setting, excessive air rate (air rate)the higher the distance, the closer;
- At room temperature, the lower the voltage, the lower the power.

7.2 Module is easy to damage

- Check the power supply to ensure that permanent damage to the module occurs between recommended supply voltages, if exceeded;
- Please check the stability of the power supply. The voltage cannot fluctuate significantly and frequently.
- Please ensure anti-static operation during installation and high frequency device electrostatic sensitivity;
- Please ensure that the installation process is not too humid. Some components are humidity sensitive.
- If there is no special requirement, it is not recommended to use it at too high and too low temperatures.

7.3 The error rate is too high

- There is interference from the same frequency signal nearby, away from the source of interference, or from modifying frequency and channel;
- The clock waveforms on the UART are not standard. Check for interference on the UART line;
- Poor power supply may also cause confusion. Be sure to ensure the reliability of the power supply;

8. Welding instruction

8.1 Reflow Welding Temperature

Profile Feature	Curvilinear characteristics	Sn-Pb Assembly	Pb-Free Assembly
Solder Paste	Tin ointment	Sn63/Pb37	Sn96.5/Ag3/Cu0.5
Preheat Temperature min (T _{smin})	Minimum preheating temperature	100°C	150°C
Preheat temperature max (T _{smax})	Maximum preheating temperature	150°C	200°C
Preheat Time (T _{smin} to T _{smax})(t _s)	Preheat time	60-120 sec	60-120 sec
Average ramp-up rate(T _{smax} to T _p)	Average ascent rate	3°C/second max	3°C/second max
Liquidous Temperature (TL)	Liquidus temperature	183°C	217°C
Time (t _L) Maintained Above (TL)	Time above liquidus	60-90 sec	30-90 sec
Peak temperature (T _p)	Peak temperature	220-235°C	230-250°C
Aveage ramp-down rate (T _p to T _{smax})	Average descent rate	6°C/second max	6°C/second max
Time 25°C to peak temperature	Time from 25°C to peak temperature	6 minutes max	minutes max

8.2 Backflow Welding Curve

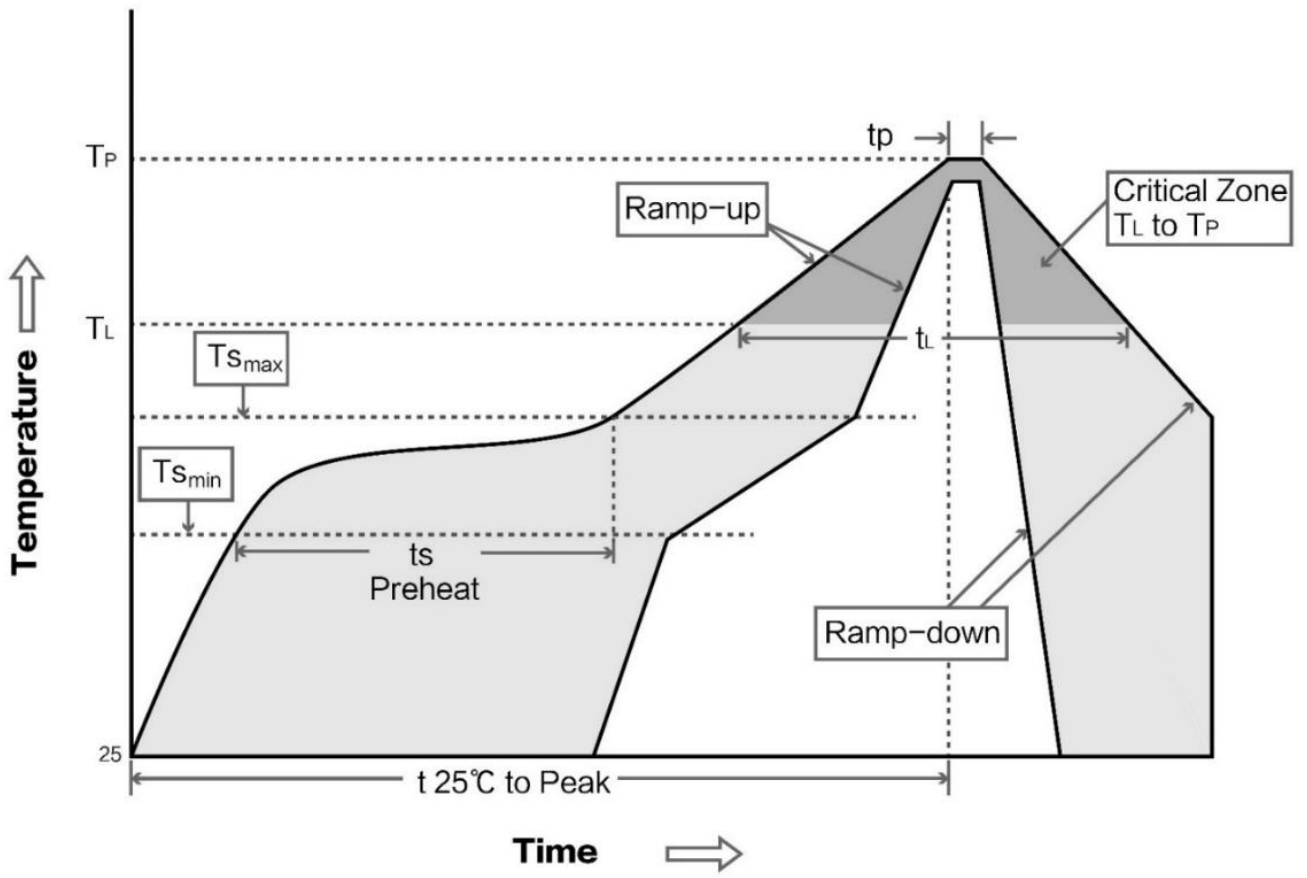

9. Revision history

Version	Date	Description	Issued by
1.0	2021-04-14	Initial version	-

About us

Technical support: support@cdebyte.com

Documents and RF Setting download link: www.ebyte.com

Thank you for using Ebyte products! Please contact us with any questions or suggestions: info@cdebyte.com

Phone: +86 028-61399028

Web: www.ebyte.com

Address: B5 Mould Park, 199# Xiqu Ave, High-tech District, Sichuan, China

 **Chengdu Ebyte Electronic Technology Co.,Ltd.**