

15W, wide input isolated & regulated
DC/DC converter



Patent Protection **RoHS**

FEATURES

- Wide range of input voltage (2:1)
- Efficiency up to 86%
- Isolation voltage : 1.5K VDC
- Output short circuit protection
- Operating temperature range: -40°C to +85°C
- Six-sided metal shielding package
- International standard pin-out

VRA(B)_LD-15W series are applied to wide voltage range input situation such as data transmission device, battery power supply device, telecommunication device, distributed power supply system, remote control system, industrial robot system etc.

Selection Guide

Part No. ①	Input Voltage (VDC)		Output		Efficiency (% Typ.) @ Full Load	Max. Capacitive Load③(μF)
	Nominal (Range)	Max.②	Output Voltage (VDC)	Output Current (mA)(Max./Min.)		
VRA1205LD-15W	12 (9-18)	20	±5	±1500/±150	83	1020
VRA1212LD-15W			±12	±625/±62.5	85	495
VRA1215LD-15W			±15	±500/±50	85	165
VRA1224LD-15W			±24	±315/±32	83	200
VRB1203LD-15W			3.3	4000/400	79	10500
VRB1205LD-15W			5	3000/300	81	4020
VRB1212LD-15W			12	1250/125	85	1035
VRB1215LD-15W			15	1000/100	83	705
VRB1224LD-15W			24	625/62.5	84	250
VRA2405LD-15W			24 (18-36)	40	±5	±1500/±150
VRA2412LD-15W	±12	±625/±62.5			86	495
VRA2415LD-15W	±15	±500/±50			86	165
VRA2424LD-15W	±24	±315/±32			84	200
VRB2403LD-15W	3.3	4000/400			80	10500
VRB2405LD-15W	5	3000/300			82	4020
VRB2412LD-15W	12	1250/125			85	1035
VRB2415LD-15W	15	1000/100			85	705
VRB2424LD-15W	24	625/62.5			84	250
VRA4805LD-15W	48 (36-75)	80			±5	±1500/±150
VRA4812LD-15W			±12	±625/±62.5	85	495
VRA4815LD-15W			±15	±500/±50	85	165
VRB4803LD-15W			3.3	4000/400	81	10500
VRB4805LD-15W			5	3000/300	83	4020
VRB4809LD-15W			9	1666/167	84	2200
VRB4812LD-15W			12	1250/125	85	1035
VRB4815LD-15W			15	1000/100	86	705

Note:

- ①Series with suffix "H" are heat sink mounting; such as VRB2405LD-15WH;
 ②Absolute maximum rating without damage on the converter, but it isn't recommended;
 ③The capacitive loads of positive and negative outputs are identical.

Input Specifications

Item	Operating Conditions	Min.	Typ.	Max.	Unit
Input Current (full load / no-load)	12VDC input	--	1505/30	--	mA
	24VDC input	--	710/25	--	
	48VDC input	--	350/10	--	
Reflected Ripple Current	12VDC input	--	100	--	mA
	24VDC input	--	200	--	
	48VDC input	--	200	--	
Input Impulse Voltage (1sec. max.)	12VDC input	-0.7	--	25	VDC
	24VDC input	-0.7	--	50	
	48VDC input	-0.7	--	100	
Starting Voltage	12VDC input	--	--	9	VDC
	24VDC input	--	--	17.8	
	48VDC input	--	--	35.8	
Start-up Time	Nominal input & constant resistance load	--	10	--	ms
Short Circuit Input Power		--	--	3.5	W
Input Filter		L filter			
Ctrl*	Module switch on	Ctrl suspended or connected to TTL high level (3.5-12VDC)			
	Module switch off	Ctrl pin connected to GND or low level (0-1.2VDC)			

Note: * the voltage of Ctrl pin is relative to input pin GND.

Output Specifications

Item	Operating Conditions	Min.	Typ.	Max.	Unit
Positive Voltage Accuracy		--	±1	±3	%
Negative Voltage Accuracy		--	±2	±5	
Balance of Output Voltage	Dual output, balanced load	--	±0.5	±1	
Line Regulation	Full load, the input voltage is from low voltage to high voltage	--	±0.2	±0.5	
Load Regulation	10%-100% load	--	±0.5	±1	
Cross Regulation	Dual output, main circuit with 50% load, auxiliary circuit with 10%-100% load	--	--	±5	
Transient Recovery Time	25% load step change	--	200	500	μs
Transient Response Deviation		--	±3	±5	%
Temperature Drift Coefficient	Full load	--	--	±0.03	%/°C
Ripple & Noise *	20MHz bandwidth	--	75	150	mV p-p
Output Over-current Protection	Input voltage range	120	130	150	%
Output Short circuit Protection		Hiccup, Continuous, self-recovery			

Note: * Ripple and noise tested with "parallel cable" method, please see *DC-DC Converter Application Notes* for specific operation methods.

General Specifications

Item	Operating Conditions	Min.	Typ.	Max.	Unit
Isolation Voltage	Input-output, with the test time of 1 minute and the leak current lower than 1mA	1500	--	--	VDC
Isolation Resistance	Input-output, isolation voltage 500VDC	1000	--	--	MΩ
Isolation Capacitance	Input-output, 100KHz/0.1V	--	1000	--	pF
Operating Temperature	Derating if the temperature is ≥71°C (see Fig. 1)	-40	--	85	°C
Storage Temperature		-55	--	125	
Storage Humidity	Non-condensing	5	--	95	%RH
Max. Operating Temperature for casing	Within the operating temperature curve	--	--	105	°C
Pin Welding Resistance Temperature	Welding spot is 1.5mm away from the casing, 10 seconds	--	--	300	
Switching Frequency	PWM mode	--	500	--	KHz

MTBF	MIL-HDBK-217F@25°C	1000	--	--	K hours
------	--------------------	------	----	----	---------

Physical Specifications

Casing Material	Aluminum alloy				
Package Dimensions	Horizontal package(Without heat sink)	50.80*25.40*11.80 mm			
	Horizontal package(With heat sink)	50.80*25.40*16.30 mm			
Weight	Horizontal package(Without heat sink)/ Horizontal package(With heat sink)		28g/36g (Typ.)		
Cooling Method	Free air convection				

EMC Specifications

EMI	Conducted disturbance	CISPR22/EN55022	CLASS B (see Fig.3-② for recommended circuit)		
EMS	Electrostatic discharge	IEC/EN61000-4-2	Contact ±4KV		perf. Criteria B
	EFT	IEC/EN61000-4-4	±2KV (see Fig.3-① for recommended circuit)		perf. Criteria B
	Surge	IEC/EN61000-4-5	±2KV (see Fig.3-① for recommended circuit)		perf. Criteria B

Product Characteristic Curve

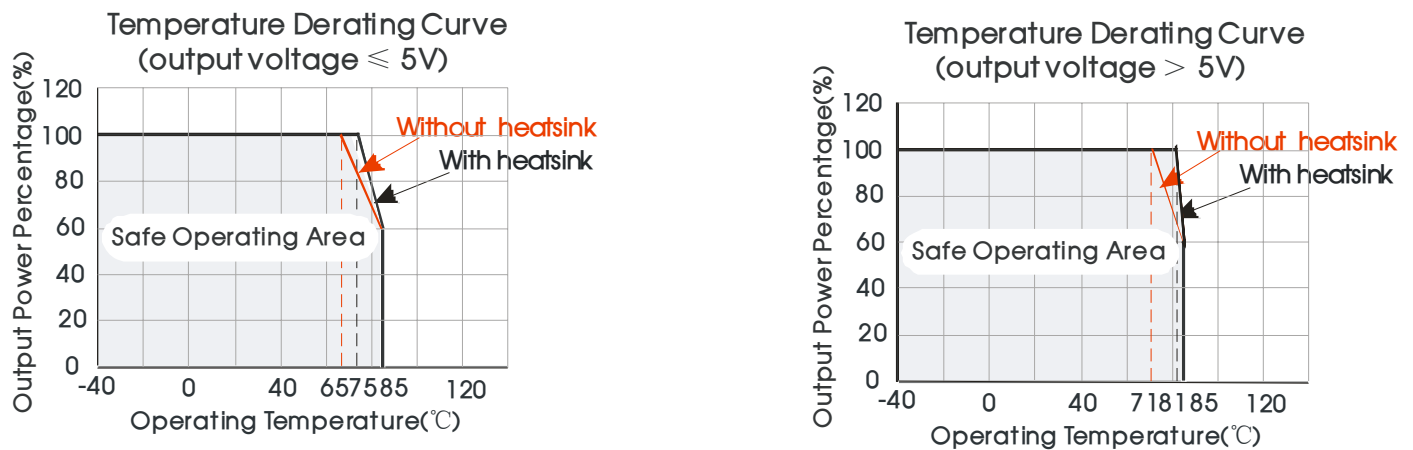
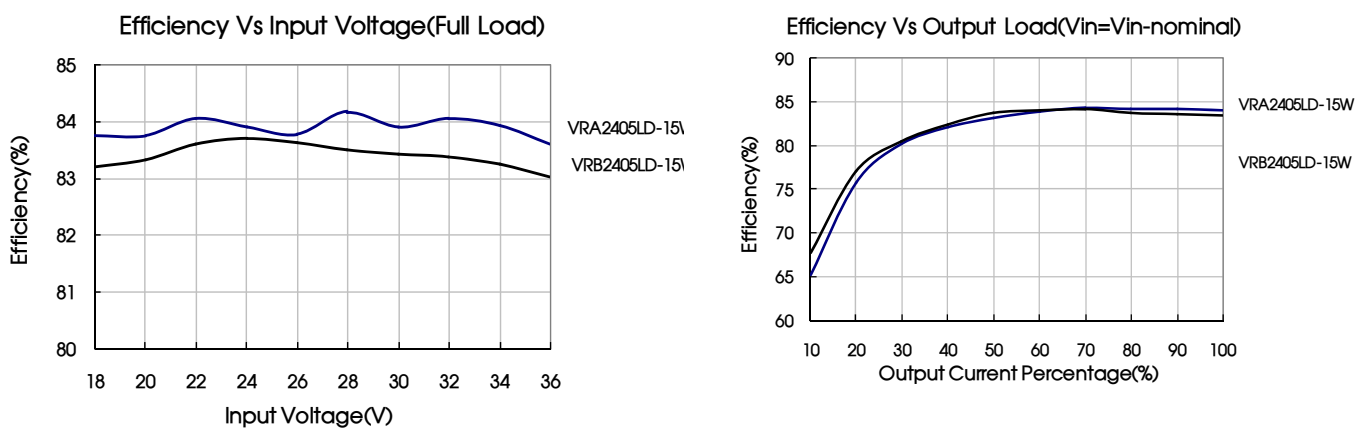

Fig. 1



Design Reference

1. Typical application

All the DC/DC converters of this series are tested according to the recommended circuit (see Fig. 2) before delivery.

If it is required to further reduce input and output ripple, properly increase the input & output of additional capacitors C_{in} and C_{out} or select capacitors of low equivalent impedance provided that the capacitance is no larger than the max. capacitive load of the product.

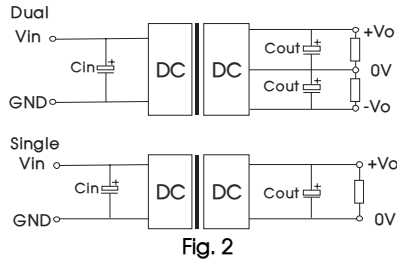

	Vout(VDC)	Cin(μF)	Cout(μF)
Single	3.3/5	100	470
	9/12/15		220
	24		100
Dual	±5	100	220
	±9/±12/±15		100
	±24		47

2. EMC solution-recommended circuit

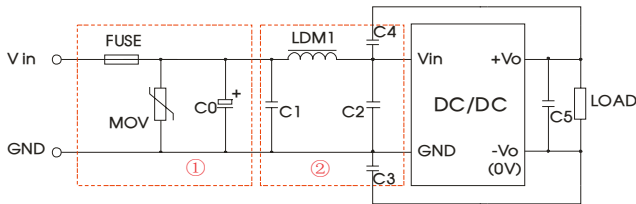

Fig. 3

Notes: Part ① in the Fig. 3 is used for EMS test and part ② for EMI filtering; selected based on needs.

Parameter description

Model	Vin:12	Vin:24V	Vin:48V
FUSE	Choose according to actual input current		
MOV	S14K20	S14K35	S14K60
C0	680μF/25V	330μF/50V	330μF/100V
C1	1μF/50V		1μF/100V
C2	4.7μF/50V		4.7μF/100V
C5	Refer to the Cout in Fig.2		
LDM1	12μH		
C3, C4	100pF/2KV		

If there is no recommended parameters, the model no require the external component.

EMC solution-recommended circuit PCB layout

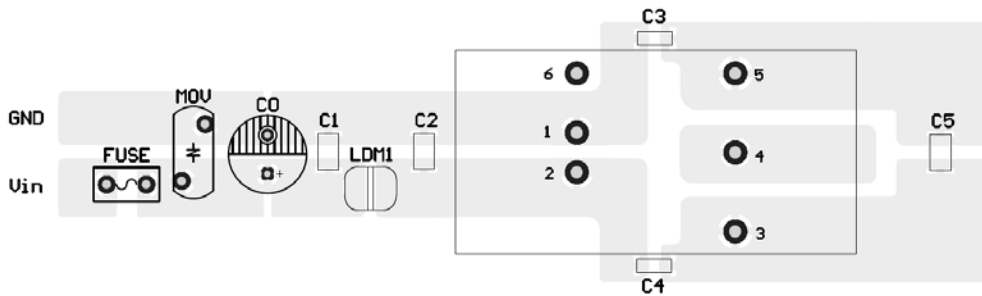
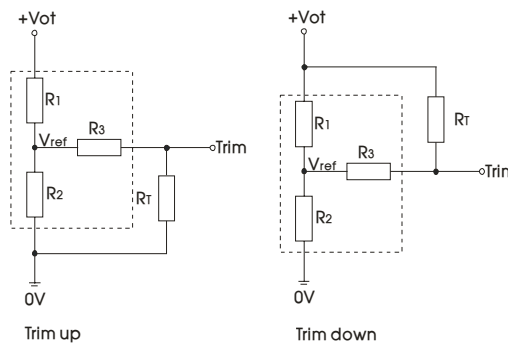

Fig. 4

Note: the min. distance of the bonding pads between input & output isolation capacitors (CY1/CY2) shall be ≥ 2mm.

3. Application of Trim and calculation of Trim resistance



Applied circuits of Trim (Part in broken line is the interior of models)

Calculation formula of Trim resistance:

$$\begin{aligned} \text{up: } R_T &= \frac{\alpha R_2}{R_2 - \alpha} - R_3 & \alpha &= \frac{V_{ref}}{V_o' - V_{ref}} \cdot R_1 \\ \text{down: } R_T &= \frac{\alpha R_1}{R_1 - \alpha} - R_3 & \alpha &= \frac{V_o' - V_{ref}}{V_{ref}} \cdot R_2 \end{aligned}$$

R_T is Trim resistance
 α is a self-defined parameter, with no real meaning.

Vout(V)	R1(K Ω)	R2(K Ω)	R3(K Ω)	Vref(V)
3.3	4.80	2.86	15	1.24
5	2.88	2.86	10	2.5
9	7.50	2.86	15	2.5
12	10.97	2.86	17.8	2.5
15	14.50	2.86	17.8	2.5
24	24.87	2.86	20	2.5

- The product does not support output in parallel with power per liter or hot-plug use
- For more information please find the application notes on www.mornsun-power.com

Dimensions and Recommended Layout(without heatsink)

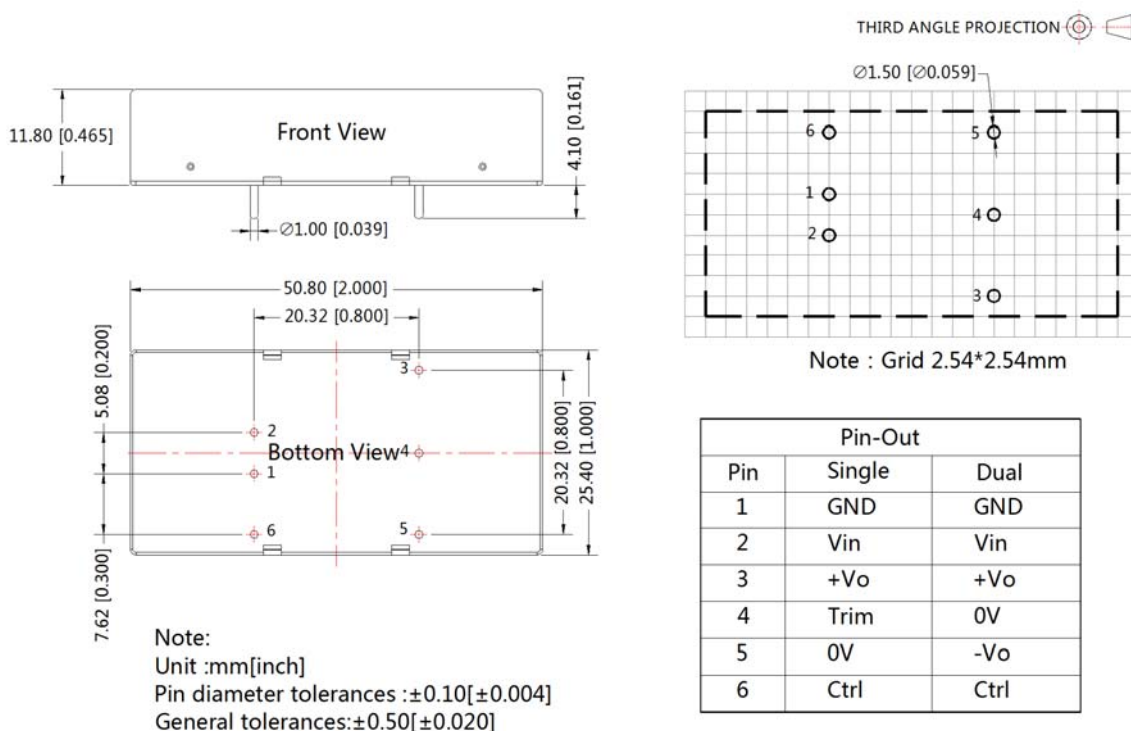

Dimensions (with heatsink)

THIRD ANGLE PROJECTION 

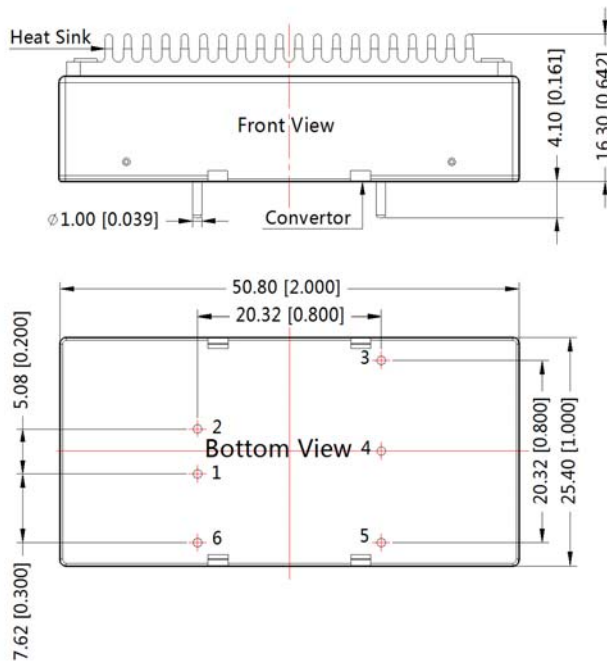

Pin-Out		
Pin	Single	Dual
1	GND	GND
2	Vin	Vin
3	+Vo	+Vo
4	Trim	0V
5	0V	-Vo
6	Ctrl	Ctrl

Note:
Unit :mm[inch]
General tolerances:±0.50[±0.020]
If use heatsinks,make sure there is enough space for a special size in ther above graph

Notes:

1. Packing Information please refer to 'Product Packing Information'. The Packing bag number of Horizontal package: 58200035(without heat sink), 58200051(with heat sink);
2. Recommended used in more than 10% load, if the load is lower than 10%, then the ripple index of the product may exceed the specification, but does not affect the reliability of the product;
3. The unbalance degree of the recommended dual output module load: ≤ 5%; if the degree exceeds ±5%, then the product performances cannot be guaranteed to comply with all the performance indicators in the manual, and please directly contact our technicians for specific information;
4. The max. capacitive load should be tested within the input voltage range and under full load conditions;
5. Unless otherwise specified, data in this datasheet should be tested under the conditions of Ta=25°C, humidity<75% when inputting nominal voltage and outputting rated load;
6. All index testing methods in this datasheet are based on our Company's corporate standards;
7. The performance indexes of the product models listed in this datasheet are as above, but some indexes of non-standard model products will exceed the above-mentioned requirements, and please directly contact our technicians for specific information;
8. We can provide product customization service;
9. Specifications of this product are subject to changes without prior notice.

Mornsun Guangzhou Science & Technology Co., Ltd.

Address: No. 5, Kehui St. 1, Kehui Development Center, Science Ave., Guangzhou Science City, Luogang District, Guangzhou, P. R. China
Tel: 86-20-38601850-8801 Fax: 86-20-38601272 E-mail: info@mornsun.cn