

- RoHS Compliant and Halogen Free ①
- Low Profile (<0.7 mm)
- Dual Sided Cooling Compatible ①
- Ultra Low Package Inductance
- Optimized for High Frequency Switching ①
- Ideal for CPU Core DC-DC Converters
- Optimized for Control FET Application ①
- Compatible with existing Surface Mount Techniques ①
- 100% Rg tested
- Footprint compatible to DirectFET

Typical values (unless otherwise specified)

V_{DS}	V_{GS}	$R_{DS(on)}$	$R_{DS(on)}$		
25V max	±16V max	2.8mΩ @ 10V	4.1mΩ @ 4.5V		
$Q_{g\ tot}$	Q_{gd}	Q_{gs2}	Q_{rr}	Q_{oss}	$V_{gs(th)}$
11nC	4.2nC	1.4nC	23nC	11nC	1.6V

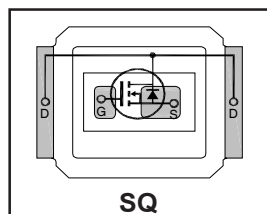

Applicable DirectFET Outline and Substrate Outline (see p.7,8 for details)

SQ	SX	ST		MQ	MX	MT	MP			
-----------	----	----	--	----	----	----	----	--	--	--

Description

The IRF6811STRPbF combines the latest HEXFET[®] Power MOSFET Silicon technology with the advanced DirectFET[®] packaging to achieve improved performance in a package that has the footprint of a MICRO-8 and only 0.7 mm profile. The DirectFET[®] package is compatible with existing layout geometries used in power applications, PCB assembly equipment and vapor phase, infra-red or convection soldering techniques, when application note AN-1035 is followed regarding the manufacturing methods and processes. The DirectFET[®] package allows dual sided cooling to maximize thermal transfer in power systems, improving previous best thermal resistance by 80%.

The IRF6811STRPbF has low gate resistance and low charge along with ultra low package inductance providing significant reduction in switching losses. The reduced losses make this product ideal for high efficiency DC-DC converters that power the latest generation of processors operating at higher frequencies. The IRF6811STRPbF has been optimized for the control FET socket of synchronous buck operating from 12 volt bus converters.

Absolute Maximum Ratings

	Parameter	Max.	Units
V_{DS}	Drain-to-Source Voltage	25	V
V_{GS}	Gate-to-Source Voltage	±16	
$I_D @ T_A = 25^\circ C$	Continuous Drain Current, $V_{GS} @ 10V$ ③	19	A
$I_D @ T_A = 70^\circ C$	Continuous Drain Current, $V_{GS} @ 10V$ ③	15	
$I_D @ T_C = 25^\circ C$	Continuous Drain Current, $V_{GS} @ 10V$ ④	74	
I_{DM}	Pulsed Drain Current ⑤	150	
E_{AS}	Single Pulse Avalanche Energy ⑥	32	mJ
I_{AR}	Avalanche Current ⑤	15	A

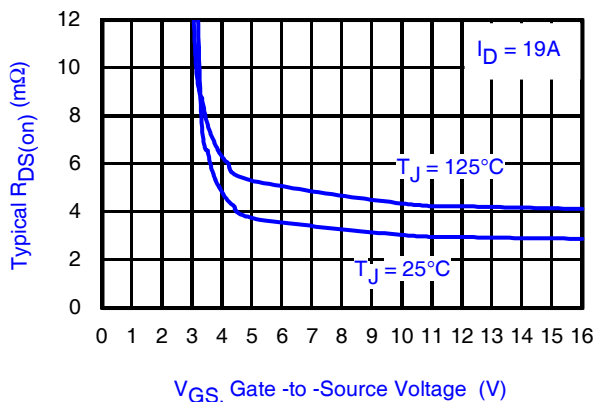

Fig 1. Typical On-Resistance vs. Gate Voltage

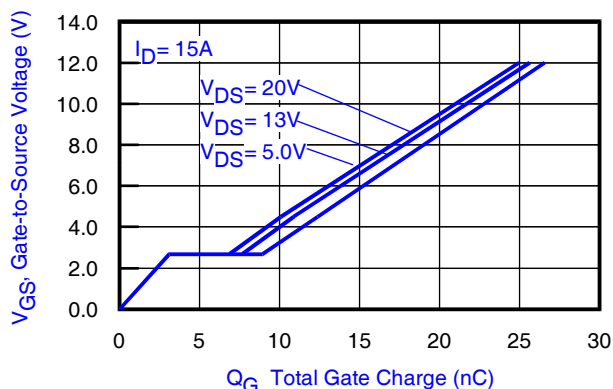

Fig 2. Typical Total Gate Charge vs. Gate-to-Source Voltage

Notes:

- ① Click on this section to link to the appropriate technical paper.
- ② Click on this section to link to the DirectFET Website.
- ③ Surface mounted on 1 in. square Cu board, steady state.

- ④ T_C measured with thermocouple mounted to top (Drain) of part.
- ⑤ Repetitive rating; pulse width limited by max. junction temperature.
- ⑥ Starting $T_J = 25^\circ C$, $L = 0.28mH$, $R_G = 50\Omega$, $I_{AS} = 15A$.

Static @ $T_J = 25^\circ\text{C}$ (unless otherwise specified)

	Parameter	Min.	Typ.	Max.	Units	Conditions
BV_{DSS}	Drain-to-Source Breakdown Voltage	25	—	—	V	$V_{GS} = 0V, I_D = 250\mu A$
$\Delta BV_{DSS}/\Delta T_J$	Breakdown Voltage Temp. Coefficient	—	22	—	mV/°C	Reference to $25^\circ\text{C}, I_D = 1\text{mA}$
$R_{DS(on)}$	Static Drain-to-Source On-Resistance	—	2.8	3.7	m Ω	$V_{GS} = 10V, I_D = 19A$ ⑦
		—	4.1	5.4		$V_{GS} = 4.5V, I_D = 15A$ ⑦
$V_{GS(th)}$	Gate Threshold Voltage	1.1	1.6	2.1	V	$V_{DS} = V_{GS}, I_D = 35\mu A$
$\Delta V_{GS(th)}/\Delta T_J$	Gate Threshold Voltage Coefficient	—	-6.2	—	mV/°C	$V_{DS} = V_{GS}, I_D = 25\mu A$
I_{DSS}	Drain-to-Source Leakage Current	—	—	1.0	μA	$V_{DS} = 20V, V_{GS} = 0V$
		—	—	150		$V_{DS} = 20V, V_{GS} = 0V, T_J = 125^\circ\text{C}$
I_{GSS}	Gate-to-Source Forward Leakage	—	—	100	nA	$V_{GS} = 16V$
	Gate-to-Source Reverse Leakage	—	—	-100		$V_{GS} = -16V$
g_{fs}	Forward Transconductance	180	—	—	S	$V_{DS} = 13V, I_D = 15A$
Q_g	Total Gate Charge	—	11	17	nC	$V_{DS} = 13V$ $V_{GS} = 4.5V$ $I_D = 15A$ See Fig. 2 & 15
Q_{gs1}	Pre-Vth Gate-to-Source Charge	—	2.2	—		
Q_{gs2}	Post-Vth Gate-to-Source Charge	—	1.4	—		
Q_{gd}	Gate-to-Drain Charge	—	4.2	—		
Q_{godr}	Gate Charge Overdrive	—	3.2	—		
Q_{sw}	Switch Charge ($Q_{gs2} + Q_{gd}$)	—	5.6	—		
Q_{oss}	Output Charge	—	11	—	nC	$V_{DS} = 16V, V_{GS} = 0V$
R_G	Gate Resistance	—	0.4	—	Ω	
$t_{d(on)}$	Turn-On Delay Time	—	8.7	—	ns	$V_{DD} = 13V, V_{GS} = 4.5V$ ⑦ $I_D = 15A$ $R_G = 1.5\Omega$ See Fig. 17
t_r	Rise Time	—	19	—		
$t_{d(off)}$	Turn-Off Delay Time	—	11	—		
t_f	Fall Time	—	5.5	—		
C_{iss}	Input Capacitance	—	1590	—	pF	$V_{GS} = 0V$ $V_{DS} = 13V$ $f = 1.0\text{MHz}$
C_{oss}	Output Capacitance	—	460	—		
C_{rss}	Reverse Transfer Capacitance	—	110	—		

Diode Characteristics

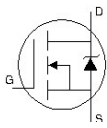
	Parameter	Min.	Typ.	Max.	Units	Conditions
I_S	Continuous Source Current (Body Diode)	—	—	40	A	MOSFET symbol showing the integral reverse p-n junction diode. 
I_{SM}	Pulsed Source Current (Body Diode) ⑤	—	—	150		
V_{SD}	Diode Forward Voltage	—	—	1.0	V	$T_J = 25^\circ\text{C}, I_S = 15A, V_{GS} = 0V$ ⑦
t_{rr}	Reverse Recovery Time	—	18	27	ns	$T_J = 25^\circ\text{C}, I_F = 15A$
Q_{rr}	Reverse Recovery Charge	—	23	35	nC	$di/dt = 300A/\mu s$ ⑦

Notes:

- ⑤ Repetitive rating; pulse width limited by max. junction temperature.
- ⑦ Pulse width $\leq 400\mu s$; duty cycle $\leq 2\%$.

Absolute Maximum Ratings

	Parameter	Max.	Units
$P_D @ T_A = 25^\circ\text{C}$	Power Dissipation ③	2.1	W
$P_D @ T_A = 70^\circ\text{C}$	Power Dissipation ③	1.3	
$P_D @ T_C = 25^\circ\text{C}$	Power Dissipation ④	32	
T_P	Peak Soldering Temperature	270	°C
T_J	Operating Junction and	-40 to + 150	
T_{STG}	Storage Temperature Range		

Thermal Resistance

	Parameter	Typ.	Max.	Units
$R_{\theta JA}$	Junction-to-Ambient ③⑩	—	60	°C/W
$R_{\theta JA}$	Junction-to-Ambient ⑥⑩	12.5	—	
$R_{\theta JA}$	Junction-to-Ambient ⑨⑩	20	—	
$R_{\theta JC}$	Junction-to-Case ④⑩	—	3.9	
$R_{\theta J-PCB}$	Junction-to-PCB Mounted	1.0	—	
	Linear Derating Factor ③	0.017		W/°C

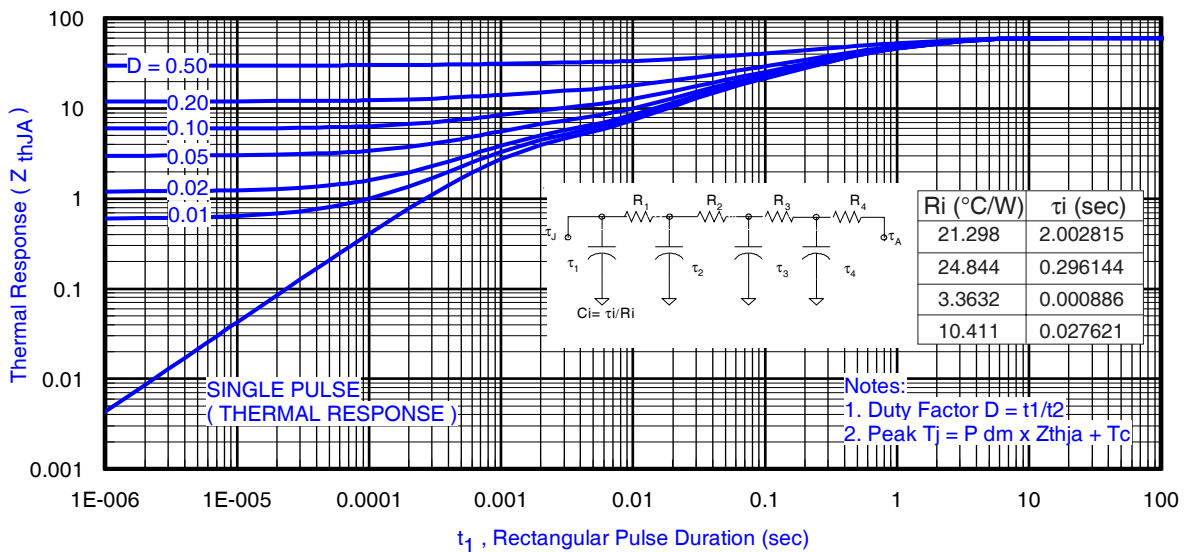
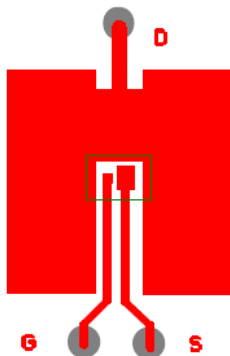

Fig 3. Maximum Effective Transient Thermal Impedance, Junction-to-Ambient ①

Notes:

- ③ Used double sided cooling, mounting pad with large heatsink.
- ④ Mounted on minimum footprint full size board with metalized back and with small clip heatsink.
- ⑥ R_{θ} is measured at T_J of approximately 90°C .



③ Surface mounted on 1 in. square Cu (still air).

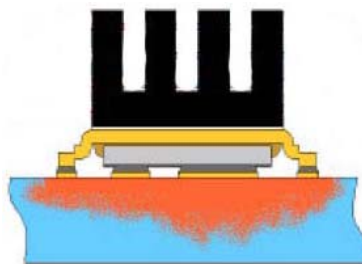

⑥ Mounted to a PCB with small clip heatsink (still air)

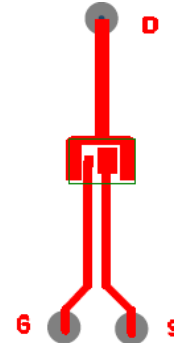

⑨ Mounted on minimum footprint full size board with metalized back and with small clip heatsink (still air)

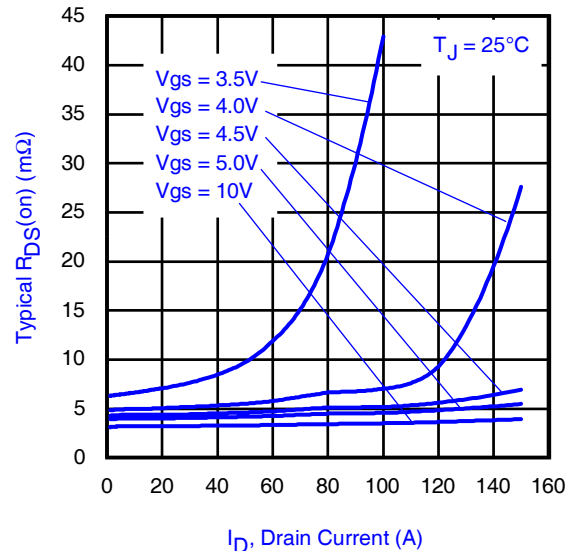
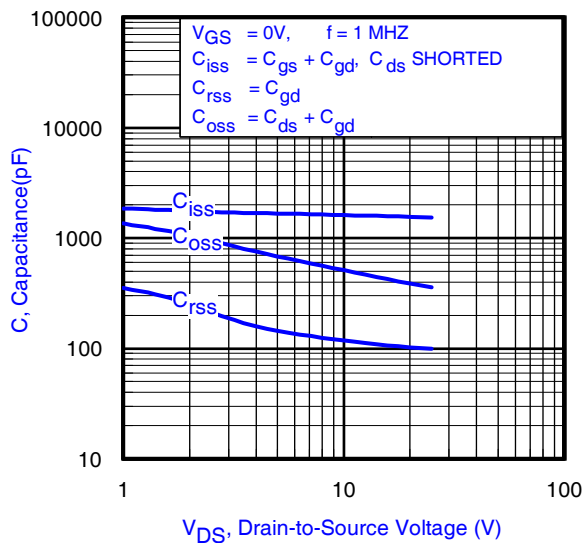
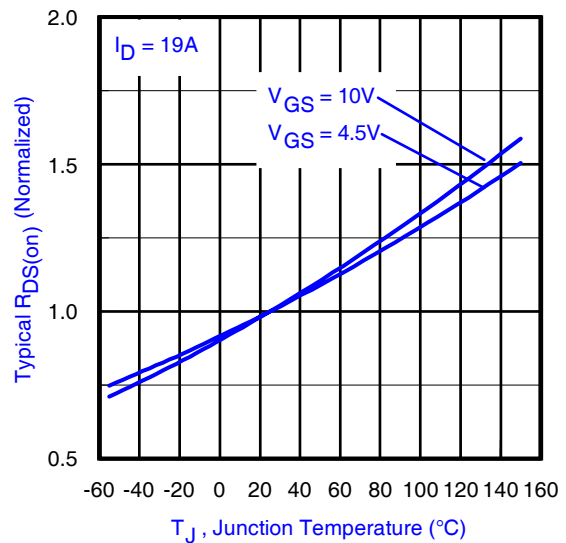
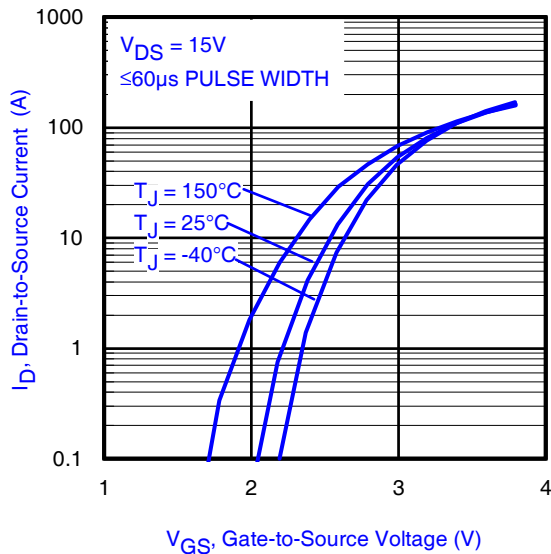
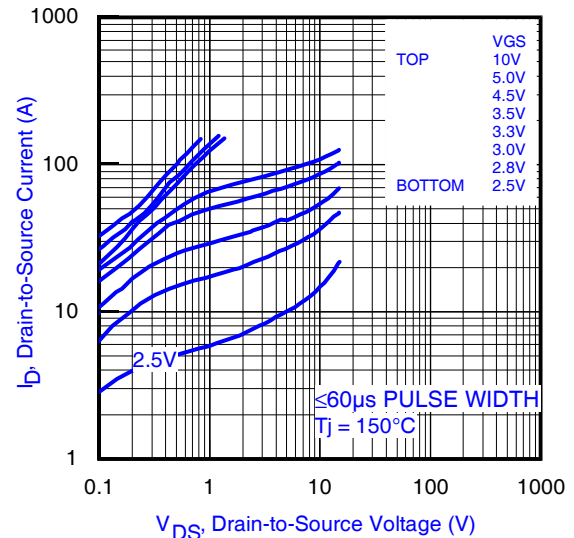
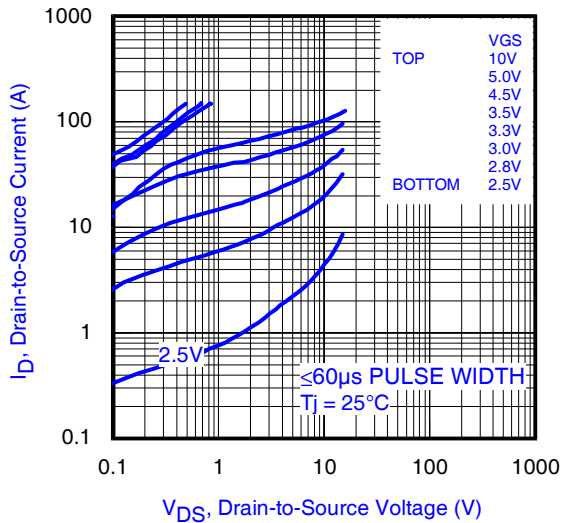

Fig 8. Typical Capacitance vs. Drain-to-Source Voltage

Fig 9. Typical On-Resistance vs. Drain Current and Gate Voltage

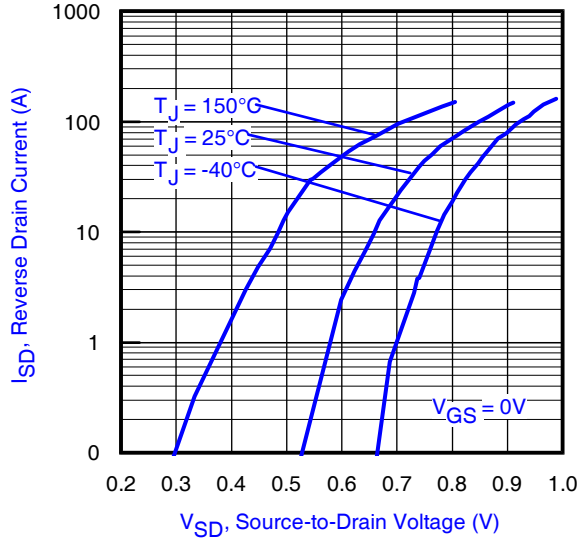

Fig 10. Typical Source-Drain Diode Forward Voltage

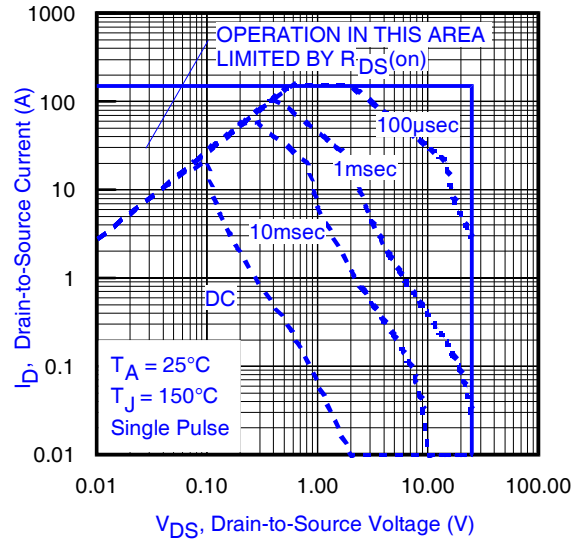

Fig 11. Maximum Safe Operating Area

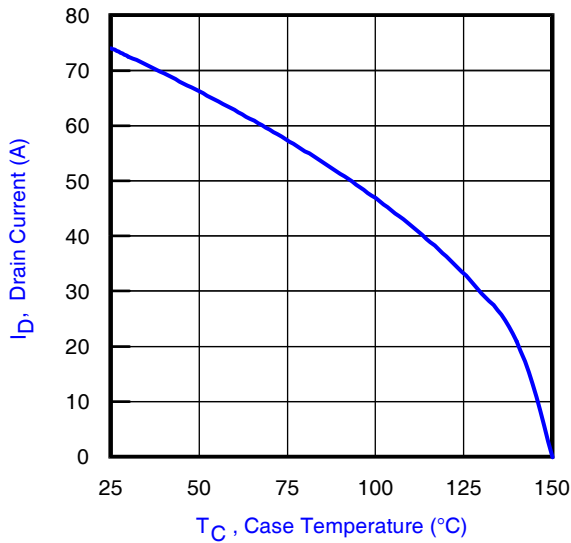

Fig 12. Maximum Drain Current vs. Case Temperature

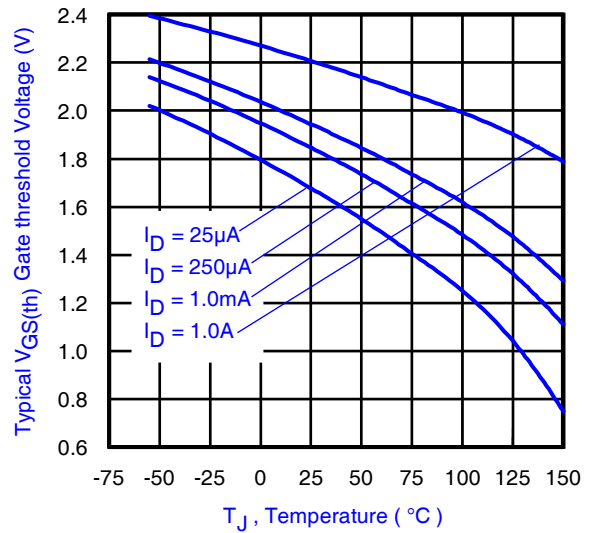

Fig 13. Typical Threshold Voltage vs. Junction Temperature

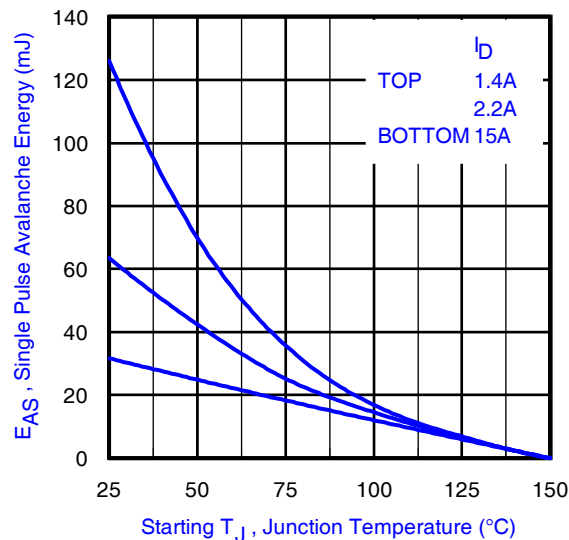

Fig 14. Maximum Avalanche Energy vs. Drain Current

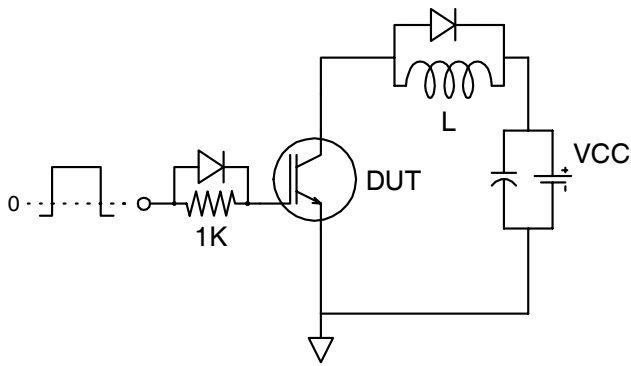

Fig 15a. Gate Charge Test Circuit

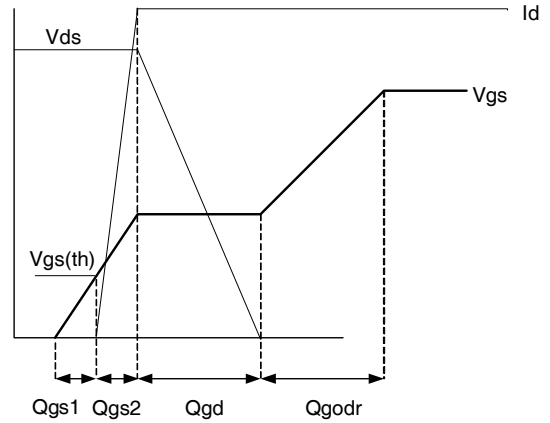

Fig 15b. Gate Charge Waveform

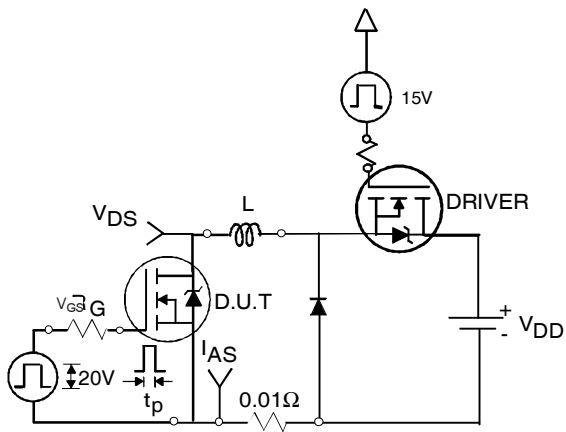

Fig 16a. Unclamped Inductive Test Circuit

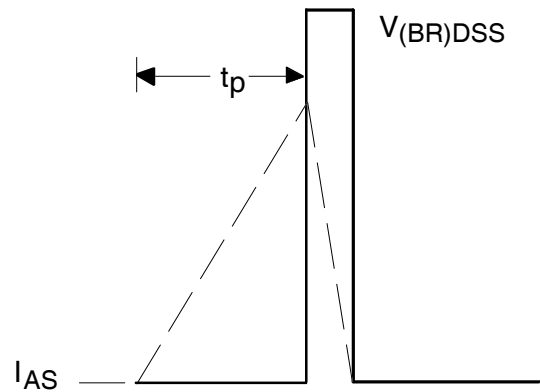

Fig 16b. Unclamped Inductive Waveforms

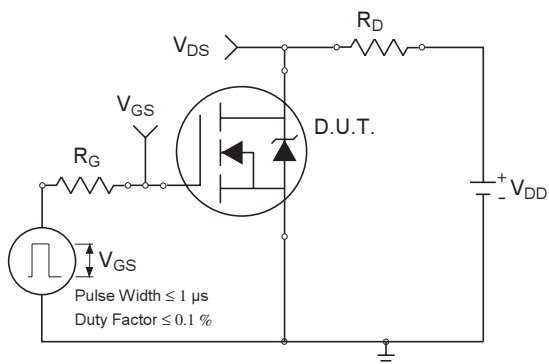

Fig 17a. Switching Time Test Circuit

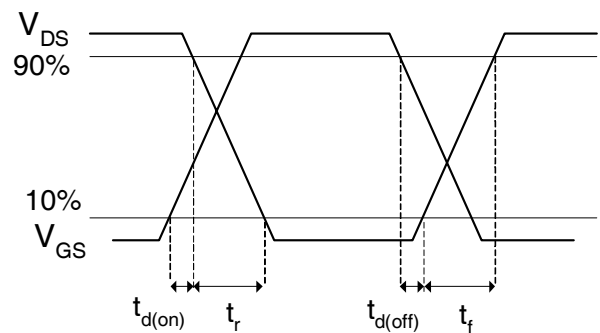

Fig 17b. Switching Time Waveforms

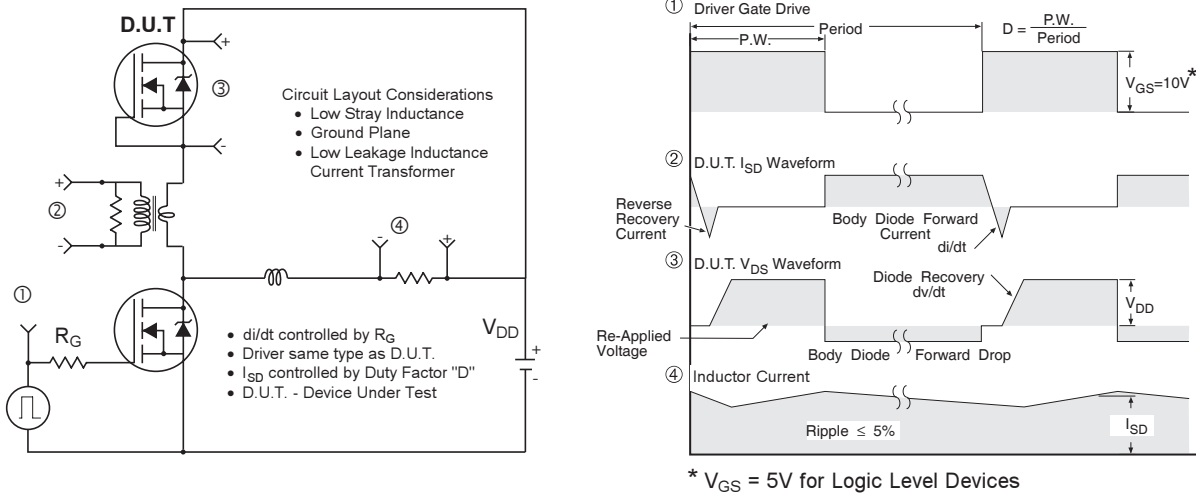
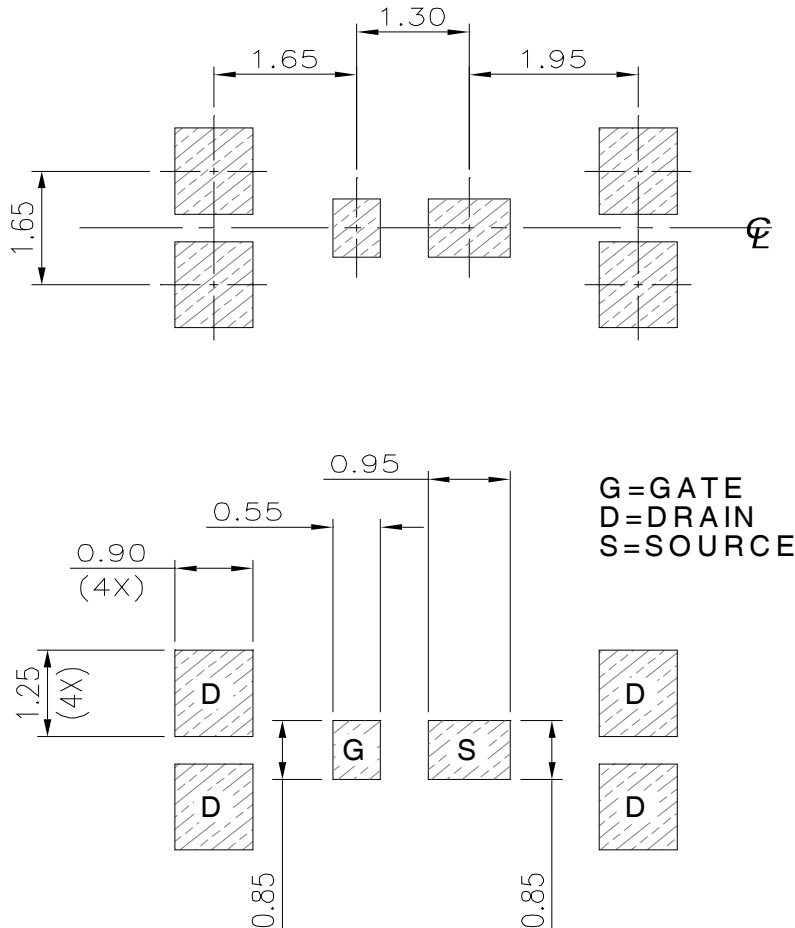

Fig 18. Diode Reverse Recovery Test Circuit for N-Channel HEXFET® Power MOSFETs

DirectFET®plus Board Footprint, SQ Outline (Small Size Can, Q-Designation).

Please see DirectFET application note AN-1035 for all details regarding the assembly of DirectFET. This includes all recommendations for stencil and substrate designs.



IRF6811SPbF

DirectFET[®]*plus* Outline Dimension, SQ Outline (Small Size Can, Q-Designation).

Please see DirectFET application note AN-1035 for all details regarding the assembly of DirectFET. This includes all recommendations for stencil and substrate designs.

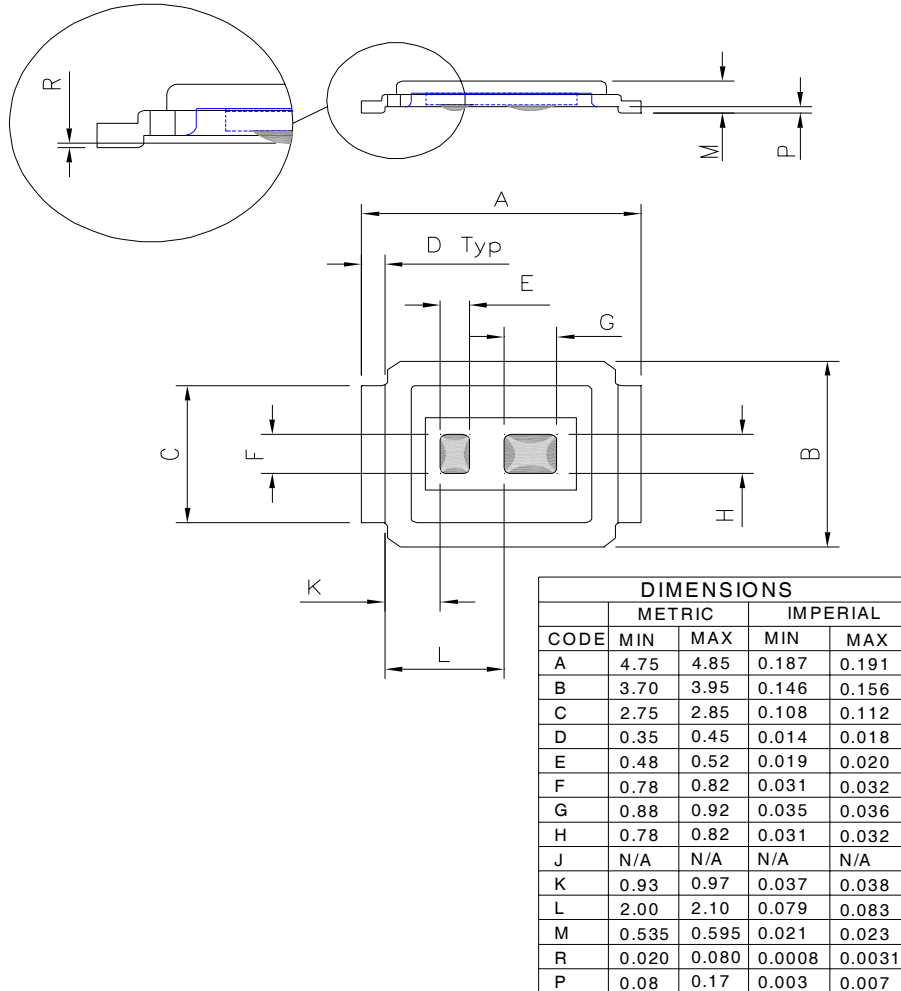

DirectFET[®]*plus* Part Marking

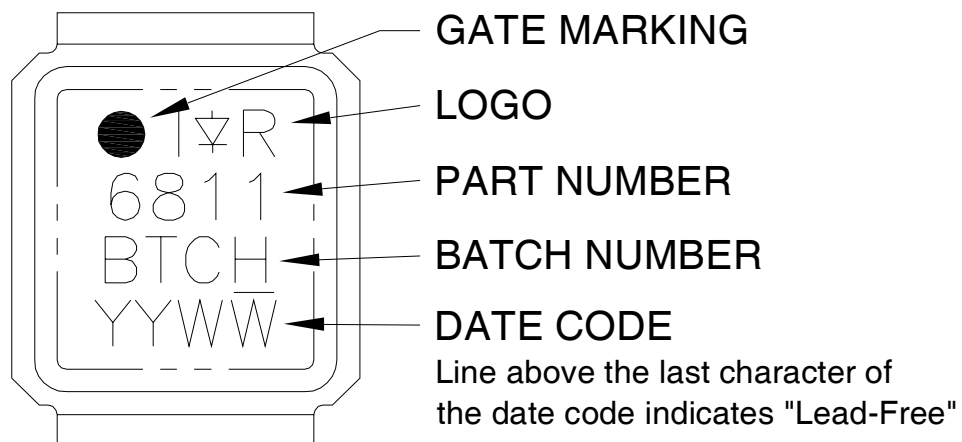

Note: For the most current drawing please refer to IR website at <http://www.irf.com/package>

DirectFET[®]plus Tape & Reel Dimension (Showing component orientation).

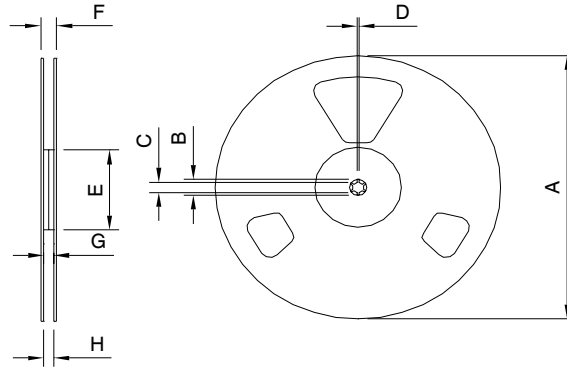

NOTE: Controlling dimensions in mm
 Std reel quantity is 4800 parts. (ordered as IRF6811STRPBF). For 1000 parts on 7" reel, order IRF6811STR1PBF

REEL DIMENSIONS									
CODE	STANDARD OPTION (QTY 4800)				TR1 OPTION (QTY 1000)				
	METRIC		IMPERIAL		METRIC		IMPERIAL		
A	330.0	N.C	12.992	N.C	177.77	N.C	6.9	N.C	
B	20.2	N.C	0.795	N.C	19.06	N.C	0.75	N.C	
C	12.8	13.2	0.504	0.520	13.5	12.8	0.53	0.50	
D	1.5	N.C	0.059	N.C	1.5	N.C	0.059	N.C	
E	100.0	N.C	3.937	N.C	58.72	N.C	2.31	N.C	
F	N.C	18.4	N.C	0.724	N.C	13.50	N.C	0.53	
G	12.4	14.4	0.488	0.567	11.9	12.01	0.47	N.C	
H	11.9	15.4	0.469	0.606	11.9	12.01	0.47	N.C	

LOADED TAPE FEED DIRECTION

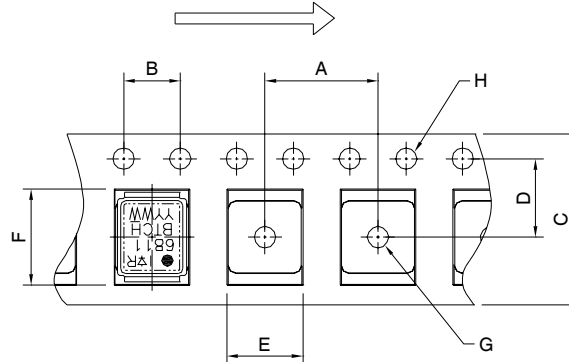

NOTE: CONTROLLING DIMENSIONS IN MM

CODE	DIMENSIONS			
	METRIC		IMPERIAL	
A	7.90	8.10	0.311	0.319
B	3.90	4.10	0.154	0.161
C	11.90	12.30	0.469	0.484
D	5.45	5.55	0.215	0.219
E	4.00	4.20	0.158	0.165
F	5.00	5.20	0.197	0.205
G	1.50	N.C	0.059	N.C
H	1.50	1.60	0.059	0.063

Note: For the most current drawing please refer to IR website at <http://www.irf.com/package>

Data and specifications subject to change without notice.
 This product has been designed and qualified for the Consumer market.
 Qualification Standards can be found on IR's Web site.

IMPORTANT NOTICE

The information given in this document shall in no event be regarded as a guarantee of conditions or characteristics ("Beschaffheitsgarantie").

With respect to any examples, hints or any typical values stated herein and/or any information regarding the application of the product, Infineon Technologies hereby disclaims any and all warranties and liabilities of any kind, including without limitation warranties of non-infringement of intellectual property rights of any third party.

In addition, any information given in this document is subject to customer's compliance with its obligations stated in this document and any applicable legal requirements, norms and standards concerning customer's products and any use of the product of Infineon Technologies in customer's applications.

The data contained in this document is exclusively intended for technically trained staff. It is the responsibility of customer's technical departments to evaluate the suitability of the product for the intended application and the completeness of the product information given in this document with respect to such application.

For further information on the product, technology, delivery terms and conditions and prices please contact your nearest Infineon Technologies office (www.infineon.com).

WARNINGS

Due to technical requirements products may contain dangerous substances. For information on the types in question please contact your nearest Infineon Technologies office.

Except as otherwise explicitly approved by Infineon Technologies in a written document signed by authorized representatives of Infineon Technologies, Infineon Technologies' products may not be used in any applications where a failure of the product or any consequences of the use thereof can reasonably be expected to result in personal injury.