

### Ultrafast Soft Recovery Diode

#### Features

- Ultrafast Recovery
- 175°C Operating Junction Temperature
- Screw Mounting Only
- Lead-Free Plating

#### Benefits

- Reduced RFI and EMI
- Higher Frequency Operation
- Reduced Snubbing
- Reduced Parts Count

#### Description/ Applications

These diodes are optimized to reduce losses and EMI/ RFI in high frequency power conditioning systems. The softness of the recovery eliminates the need for a snubber in most applications. These devices are ideally suited for HF welding, power converters and other applications where switching losses are not significant portion of the total losses.

$$t_{rr} = 50\text{ns (typ)}$$

$$I_{F(AV)} = 80\text{Amp}$$

$$V_R = 400\text{V}$$

#### Absolute Maximum Ratings

Parameters	Max	Units
$V_R$ Cathode to Anode Voltage	400	V
$I_{F(AV)}$ Continuous Forward Current, $T_C = 101^\circ\text{C}$	80	A
$I_{FSM}$ Single Pulse Forward Current, $T_C = 25^\circ\text{C}$	800	
$I_{FRM} \text{ } \textcircled{1}$ Maximum Repetitive Forward Current	160	
$T_J, T_{STG}$ Operating Junction and Storage Temperatures	- 55 to 175	$^\circ\text{C}$

$\textcircled{1}$  Square Wave, 20kHz

#### Case Styles

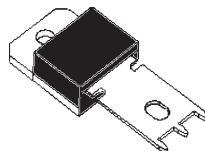

PowerTab

**Electrical Characteristics @  $T_J = 25^\circ\text{C}$  (unless otherwise specified)**

Parameters	Min	Typ	Max	Units	Test Conditions
$V_{BR}, V_r$ Breakdown Voltage, Blocking Voltage	400	-	-	V	$I_R = 100\mu\text{A}$
$V_F$ Forward Voltage	-	1.1	1.3	V	$I_F = 80\text{A}$
	-	0.92	1.08	V	$I_F = 80\text{A}, T_J = 175^\circ\text{C}$
	-	0.98	1.15	V	$I_F = 80\text{A}, T_J = 125^\circ\text{C}$
$I_R$ Reverse Leakage Current	-	-	50	$\mu\text{A}$	$V_R = V_R$ Rated
	-	-	2	mA	$T_J = 150^\circ\text{C}, V_R = V_R$ Rated
$C_T$ Junction Capacitance	-	50	-	pF	$V_R = 200\text{V}$
$L_S$ Series Inductance	-	3.5	-	nH	Measured lead to lead 5mm from package body

**Dynamic Recovery Characteristics @  $T_J = 25^\circ\text{C}$  (unless otherwise specified)**

Parameters	Min	Typ	Max	Units	Test Conditions
$t_{rr}$ Reverse Recovery Time	-	50	60	ns	$I_F = 1\text{A}, di_F/dt = 200\text{A}/\mu\text{s}, V_R = 30\text{V}$
	-	87	-		$T_J = 25^\circ\text{C}$
	-	151	-		$T_J = 125^\circ\text{C}$
$I_{RRM}$ Peak Recovery Current	-	9.3	-	A	$T_J = 25^\circ\text{C}$
	-	17.2	-		$T_J = 125^\circ\text{C}$
$Q_{rr}$ Reverse Recovery Charge	-	405	-	nC	$T_J = 25^\circ\text{C}$
	-	-	1300		$T_J = 125^\circ\text{C}$

$I_F = 80\text{A}$   
 $V_R = 200\text{V}$   
 $di_F/dt = 200\text{A}/\mu\text{s}$

**Thermal - Mechanical Characteristics**

Parameters	Min	Typ	Max	Units
$R_{thJC}$ Thermal Resistance, Junction to Case			0.70	K/W
$R_{thCS}$ ② Thermal Resistance, Case to Heatsink		0.2		
Wt Weight			5.02	g
			0.18	(oz)
T Mounting Torque	1.2		2.4	N * m
	10		20	lbf.in

② Mounting Surface, Flat, Smooth and Greased

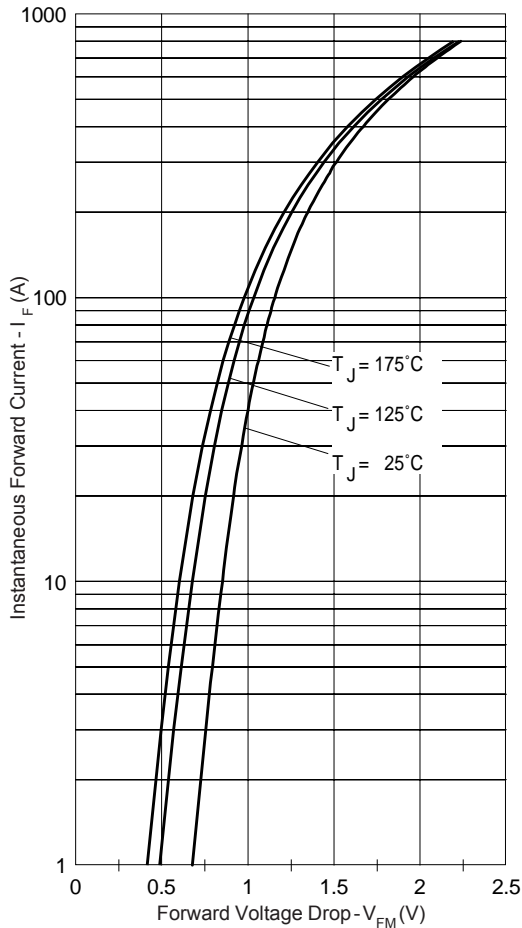

Fig. 1 - Typical Forward Voltage Drop Characteristics

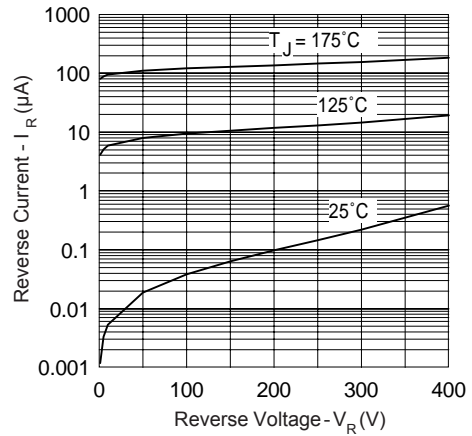

Fig. 2 - Typical Values Of Reverse Current Vs. Reverse Voltage

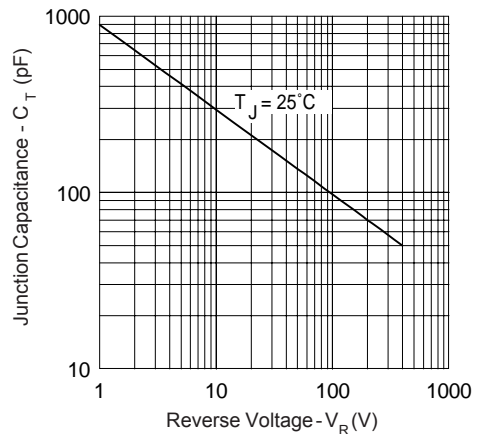

Fig. 3 - Typical Junction Capacitance Vs. Reverse Voltage

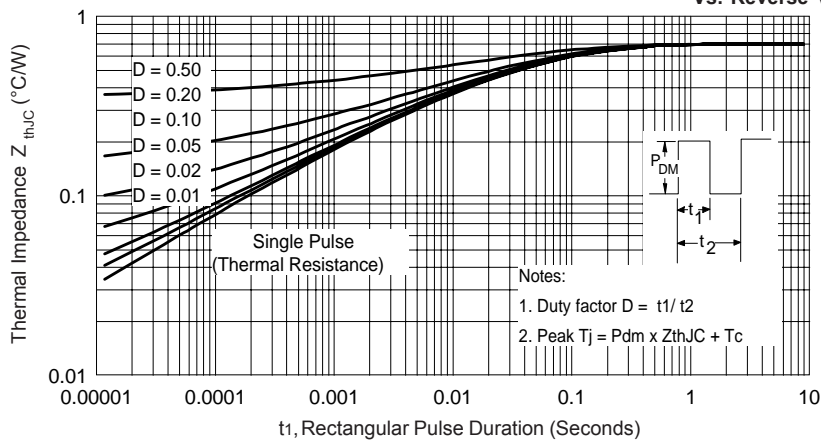

Fig. 4 - Max. Thermal Impedance  $Z_{thJC}$  Characteristics

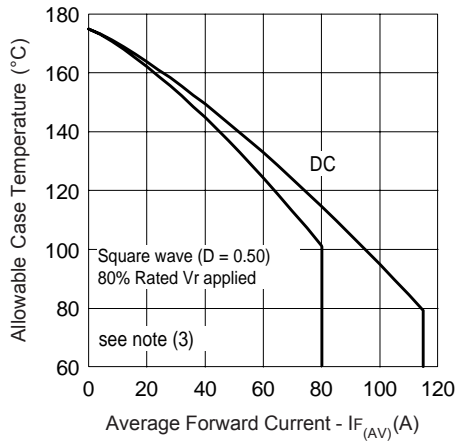

Fig. 5 - Max. Allowable Case Temperature Vs. Average Forward Current

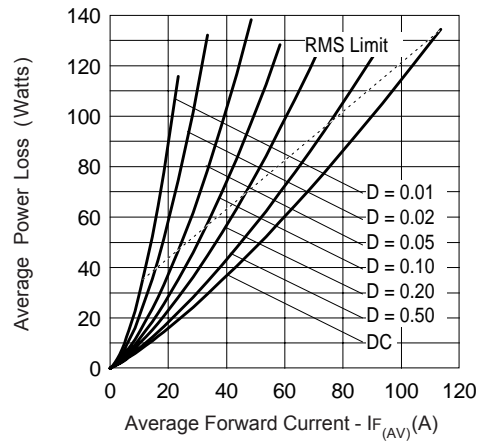

Fig. 6 - Forward Power Loss Characteristics

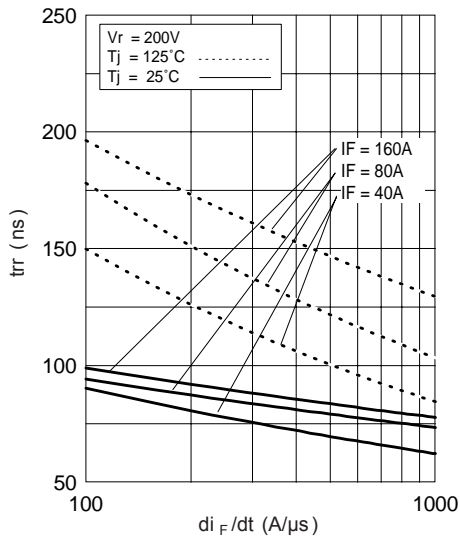

Fig. 7 - Typical Reverse Recovery time vs.  $di_F/dt$

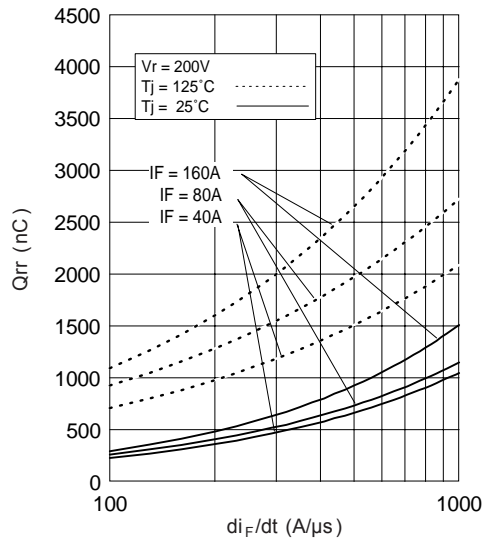

Fig. 8 - Typical Stored Charge vs.  $di_F/dt$

(3) Formula used:  $T_c = T_j - (Pd + Pd_{REV}) \times R_{thJC}$ ;

$Pd$  = Forward Power Loss =  $I_{F(AV)} \times V_{FM} @ (I_{F(AV)} / D)$  (see Fig. 6);

$Pd_{REV}$  = Inverse Power Loss =  $V_{R1} \times I_R (1 - D)$ ;  $I_R @ V_{R1} = 80\%$  rated  $V_R$

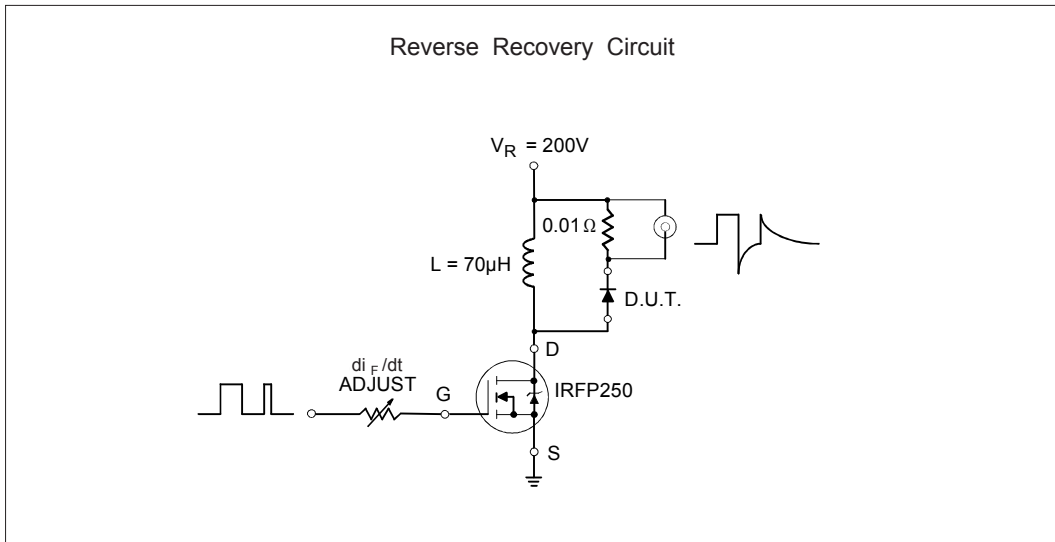

Fig. 9- Reverse Recovery Parameter Test Circuit

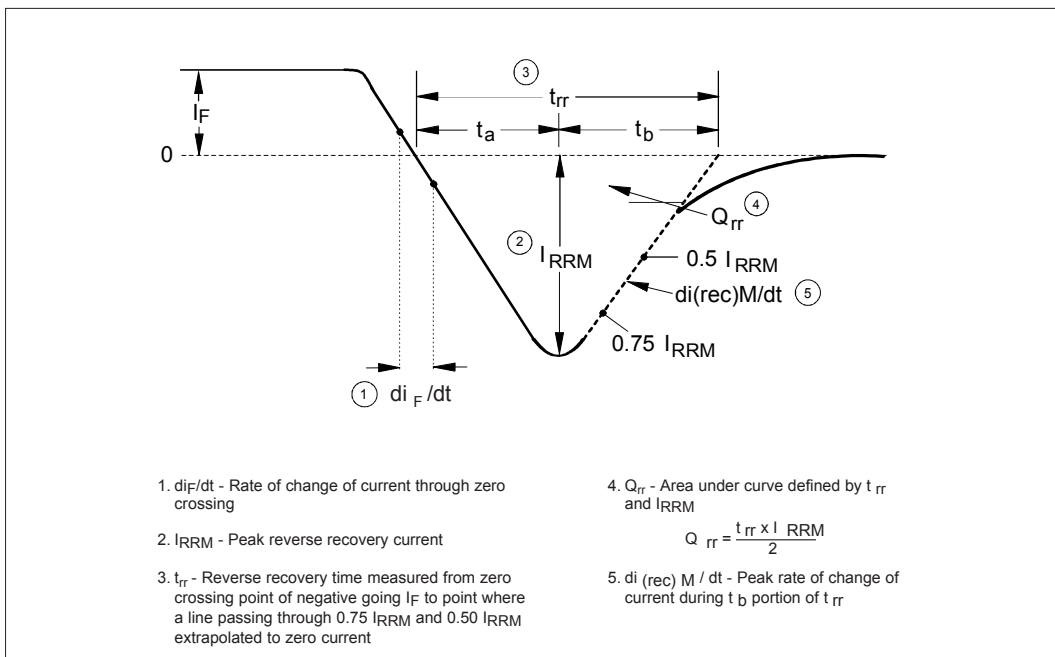
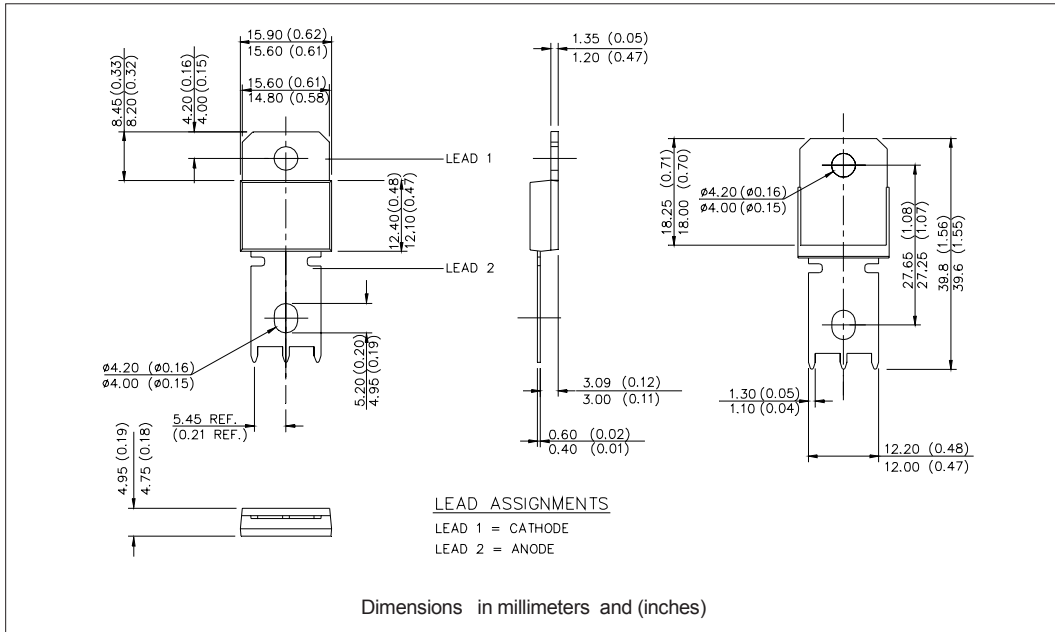

Fig. 10 - Reverse Recovery Waveform and Definitions

Outline Table



Ordering Information Table

Device Code	
<b>80</b>	<b>E B U 04</b>
①	② ③ ④ ⑤
<b>1</b>	- Current Rating (80 = 80A)
<b>2</b>	- Single Diode
<b>3</b>	- Pow/Rtab (Ultrafast/ Hyperfast only)
<b>4</b>	- Ultrafast Recovery
<b>5</b>	- Voltage Rating (04 = 400V)

Data and specifications subject to change without notice.  
This product has been designed and qualified for Industrial Level and Lead-Free.  
Qualification Standards can be found on IR's Web site.