

Surface Mount Super Fast Recovery Rectifier

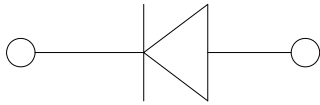
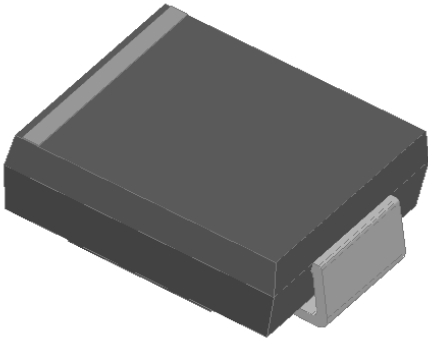

Features

- Ultrafast reverse recovery time
- Low leakage current
- Low switching losses, high efficiency
- High forward surge capability
- Solder dip 260 °C max. 10 s, per JESD 22-B106

Typical Applications

For use in high frequency rectification and freewheeling application in switching mode converters and inverters for consumer, computer and telecommunication.

Mechanical Data

- **Package:** DO-214AB (SMC)
Molding compound meets UL 94 V-0 flammability rating, RoHS-compliant
- **Terminals:** Tin plated leads, solderable per J-STD-002 and JESD22-B102
- **Polarity:** Color band denotes the cathode end

■Maximum Ratings (Ta=25°C Unless otherwise specified)

PARAMETER	SYMBOL	UNIT	ES3A	ES3B	ES3C	ES3D	ES3F	ES3G	ES3H	ES3J	ES3K
Device marking code			ES3A	ES3B	ES3C	ES3D	ES3F	ES3G	ES3H	ES3J	ES3K
Repetitive Peak Reverse Voltage	V_{RRM}	V	50	100	150	200	300	400	500	600	800
Average Rectified Output Current @60Hz sine wave, Resistance load, Ta (FIG.1)	I_O	A	3.0								
Forward Surge Current (Non-repetitive) @60Hz Half-sine wave, 1 cycle, Ta=25°C	I_{FSM}	A	100								
Storage Temperature	Tstg	°C	-55 ~+150								
Junction Temperature	Tj	°C	-55 ~+150								

■Electrical Characteristics (Ta=25°C Unless otherwise specified)

PARAMETER	SYMBOL	UNIT	TEST CONDITIONS	ES3A	ES3B	ES3C	ES3D	ES3F	ES3G	ES3H	ES3J	ES3K
Maximum instantaneous forward voltage drop per diode	V_F	V	$I_{FM}=3.0A$	0.95			1.3		1.7		1.85	
Maximum reverse recovery time	T_{RR}	ns	$I_F=0.5A, I_R=1.0A, I_{rr}=0.25A$	35								
Maximum DC reverse current at rated DC blocking voltage per diode	I_R	μA	Ta=25°C	5								
			Ta=125°C	100								
Typical junction capacitance	C_j	pF	Measured at 1MHz and Applied Reverse Voltage of 4.0 V.D.C.	60			37		23		34	



ES3A THRU ES3K

■ Thermal Characteristics (Ta=25°C Unless otherwise specified)

PARAMETER		SYMBOL	UNIT	ES3A	ES3B	ES3C	ES3D	ES3F	ES3G	ES3H	ES3J	ES3K
Thermal Resistance	junction to ambient	$R_{\theta J-A}$	°C/W	48 ¹⁾								
	junction to lead	$R_{\theta J-L}$		13 ¹⁾								

Note (1)

Thermal resistance from junction to ambient and from junction to lead mounted on P.C.B. with 0.6" x 0.6" (16 mm x 16 mm) copper pad areas

■ Ordering Information (Example)

PREFERRED P/N	PACKAGE CODE	UNIT WEIGHT(g)	MINIMUM PACKAGE(pcs)	INNER BOX QUANTITY(pcs)	OUTER CARTON QUANTITY(pcs)	DELIVERY MODE
ES3A~ES3K	F1	Approximate 0.248	3000	6000	42000	13" reel

■ Characteristics (Typical)

FIG.1: Io-TL Curve

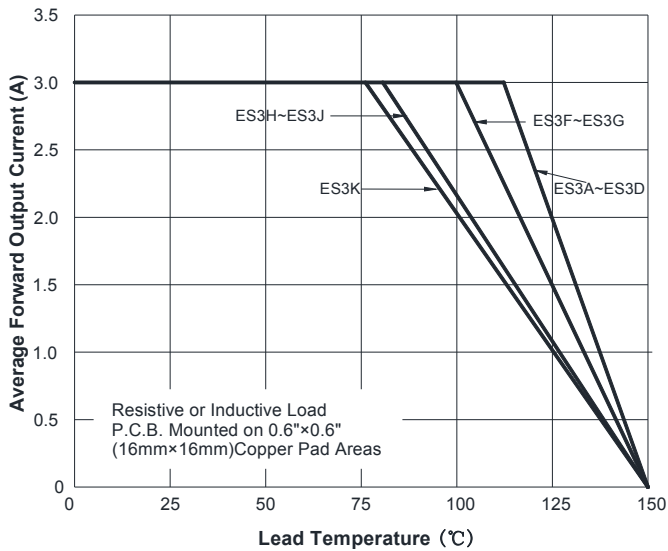

FIG.2: Forward Surge Current Capability

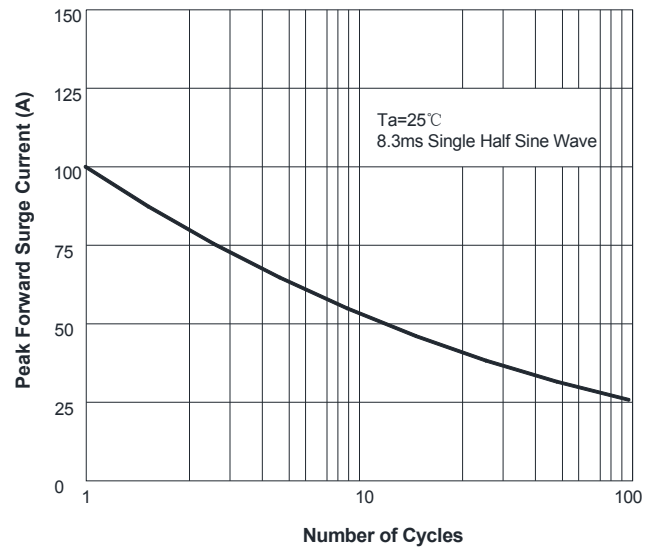

FIG.3: Forward Voltage

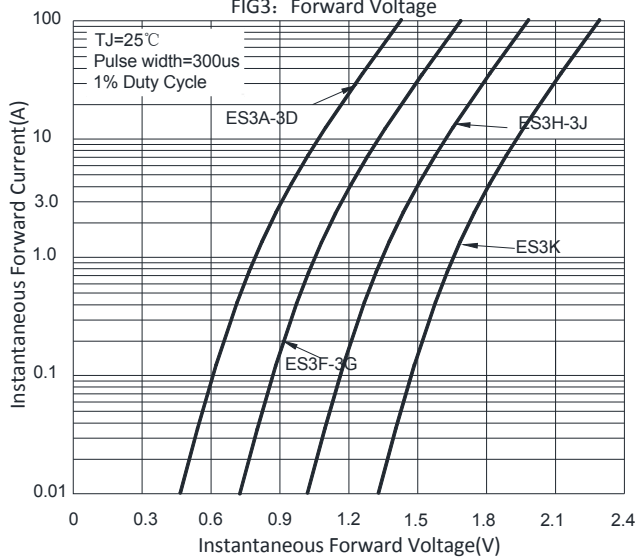

FIG.4: Typical Reverse Characteristics

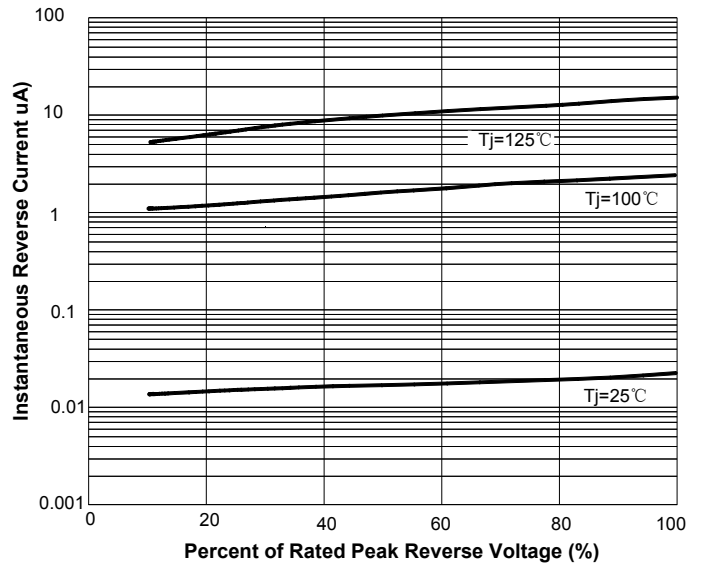
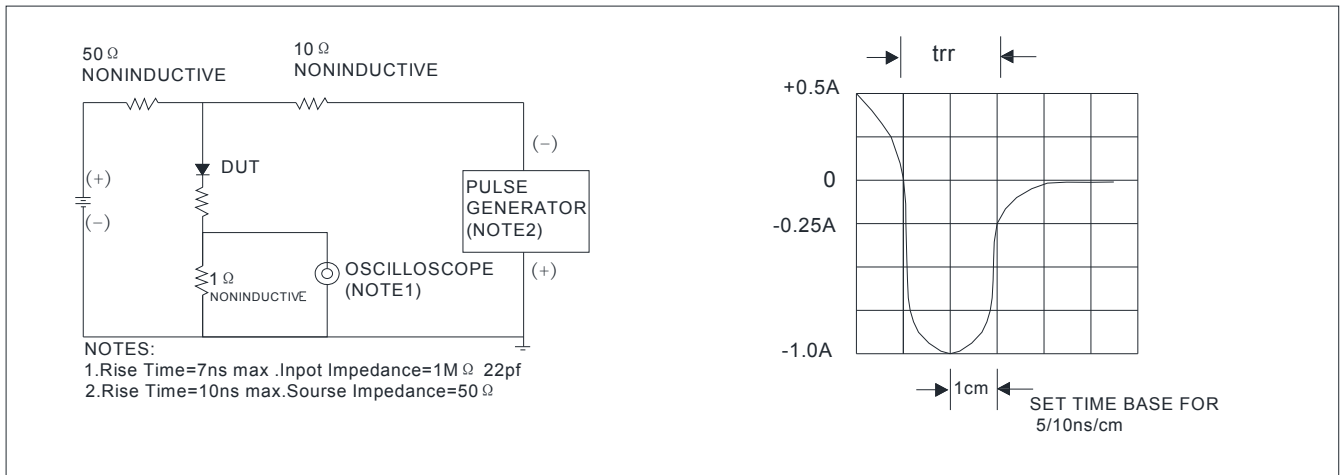
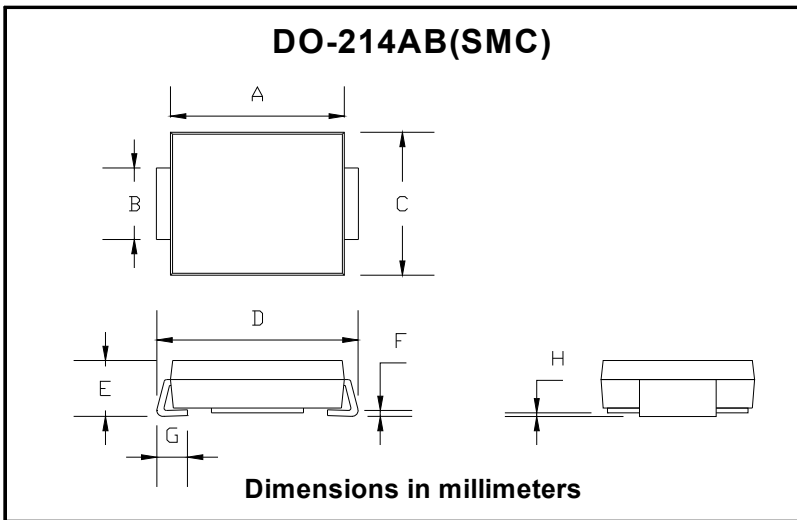

FIG.5: Diagram of circuit and Testing wave form of reverse recovery time



■ Outline Dimensions



DO-214AB (SMC)		
Dim	Min	Max
A	6.60	7.11
B	2.85	3.27
C	5.59	6.22
D	7.75	8.13
E	1.99	2.61
F	0.15	0.31
G	0.76	1.52
H	0.10	0.20

■ Suggested pad layout

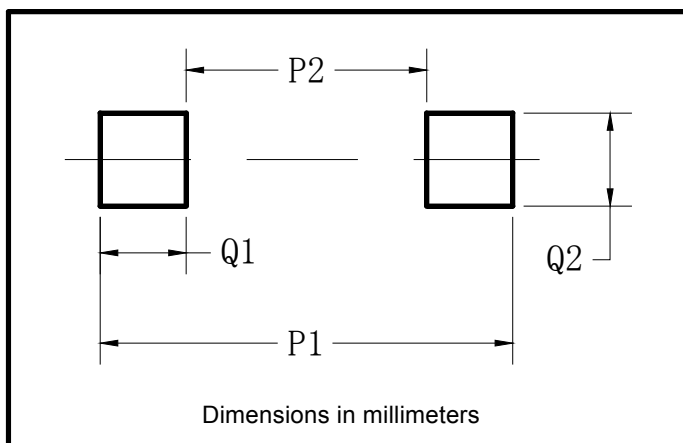

DO-214AB (SMC)	
Dim	Min
P1	9.9
P2	3.84
Q1	3.03
Q2	3.82



ES3A THRU ES3K

Disclaimer

The information presented in this document is for reference only. Yangzhou Yangjie Electronic Technology Co., Ltd. reserves the right to make changes without notice for the specification of the products displayed herein to improve reliability, function or design or otherwise.

The product listed herein is designed to be used with ordinary electronic equipment or devices, and not designed to be used with equipment or devices which require high level of reliability and the malfunction of which would directly endanger human life (such as medical instruments, transportation equipment, aerospace machinery, nuclear-reactor controllers, fuel controllers and other safety devices), Yangjie or anyone on its behalf, assumes no responsibility or liability for any damages resulting from such improper use of sale.

This publication supersedes & replaces all information previously supplied. For additional information, please visit our website [http:// www.21yangjie.com](http://www.21yangjie.com) , or consult your nearest Yangjie's sales office for further assistance.