

Ultra-Fast Recovery Rectifier Diodes

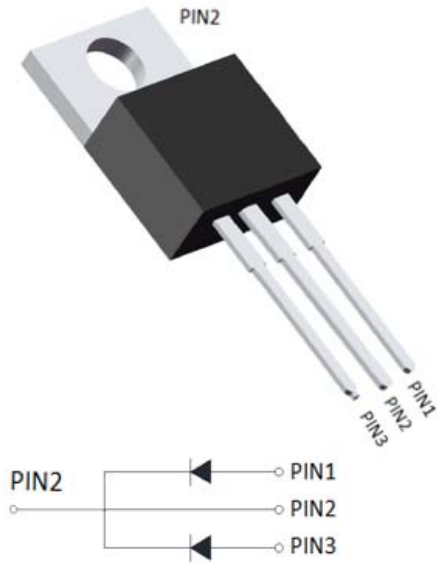

Features

- High frequency operation
- High surge forward current capability
- High purity, high temperature epoxy encapsulation for enhanced mechanical strength and moisture resistance
- Guard ring for enhanced ruggedness and long term reliability
- Solder dip 275 °C max. 7 s, per JESD 22-B106

Typical Applications

Typical applications are in switching power supplies, converters, freewheeling diodes, and reverse battery protection.

Mechanical Data

- **Package:** TO-220AB
Molding compound meets UL 94 V-0 flammability rating, RoHS-compliant
- **Terminals:** Tin plated leads, solderable per J-STD-002 and JESD22-B102
- **Polarity:** As marked

■Maximum Ratings (T_a=25°C Unless otherwise specified)

PARAMETER	SYMBOL	UNIT	MUR1610CT	MUR1615CT	MUR1620CT	MUR1640CT	MUR1660CT
Device Marking Code			MUR1610CT	MUR1615CT	MUR1620CT	MUR1640CT	MUR1660CT
Repetitive Peak Reverse Voltage	VRRM	V	100	150	200	400	600
Average Rectified Output Current @60Hz half sine-wave, R-load, T _c (FIG.1)	I _o	A	16				
Surge(Non-repetitive)Forward Current @60Hz half sine-wave, 1 cycle, T _a =25°C	I _{FSM}	A	100				
Current Squared Time @1ms≤t<8.3ms T _j =25°C, Rating of per diode	I ² t	A ² s	41				
Storage Temperature	T _{stg}	°C	-55 ~ +150				
Junction Temperature	T _j	°C	-55 ~ +150				

■Electrical Characteristics (T_a=25°C Unless otherwise specified)

PARAMETER	SYMBOL	UNIT	TEST CONDITIONS	MUR1610CT	MUR1615CT	MUR1620CT	MUR1640CT	MUR1660CT
Maximum instantaneous forward voltage drop per diode	V _{FM}	V	I _{FM} =8.0A	0.95			1.3	1.7
Maximum DC reverse current at rated DC blocking voltage per diode	I _{RRM1}	uA	V _{RM} =V _{RRM} T _a =25°C	10				
	I _{RRM2}		V _{RM} =V _{RRM} T _a =125°C	500				
Reverse Recovery Time	T _{rr}	ns	I _F =0.5A I _{RM} =1A I _{RR} =0.25A	50				



MUR1610CT THRU MUR1660CT

■ Thermal Characteristics (T_a=25°C Unless otherwise specified)

PARAMETER		SYMBOL	UNIT	MUR1610CT	MUR1615CT	MUR1620CT	MUR1640CT	MUR1660CT
Thermal Resistance	Between junction and case	R _{θJ-C}	°C/W	2.0				

■ Ordering Information (Example)

PREFERRED P/N	UNIT WEIGHT(g)	MINIMUM PACKAGE(pcs)	INNER BOX QUANTITY(pcs)	OUTER CARTON QUANTITY(pcs)	DELIVERY MODE
MUR-CT	Approximate 1.89	50	1000	5000	Tube

■ Characteristics (Typical)

FIG1: I_o -T_c Curve

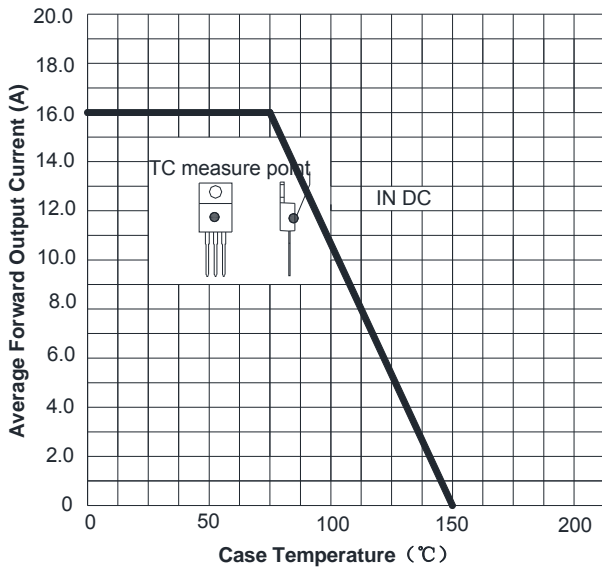

FIG2: Surge Forward Current Capability

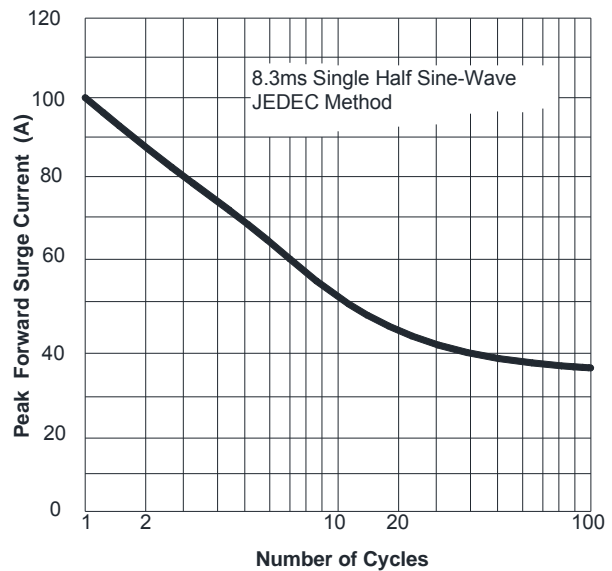

FIG3: Forward Voltage

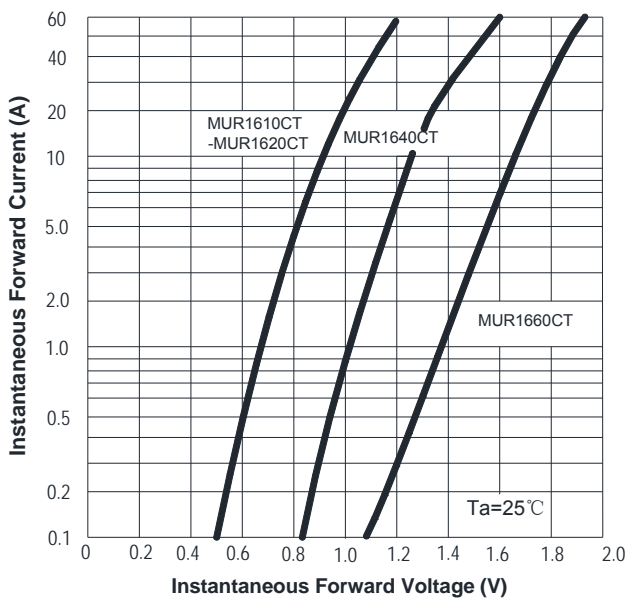

FIG4: Typical Reverse Characteristics

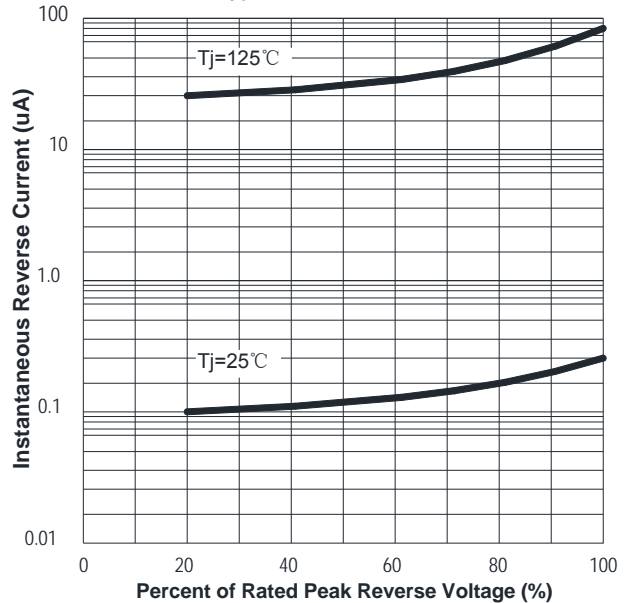
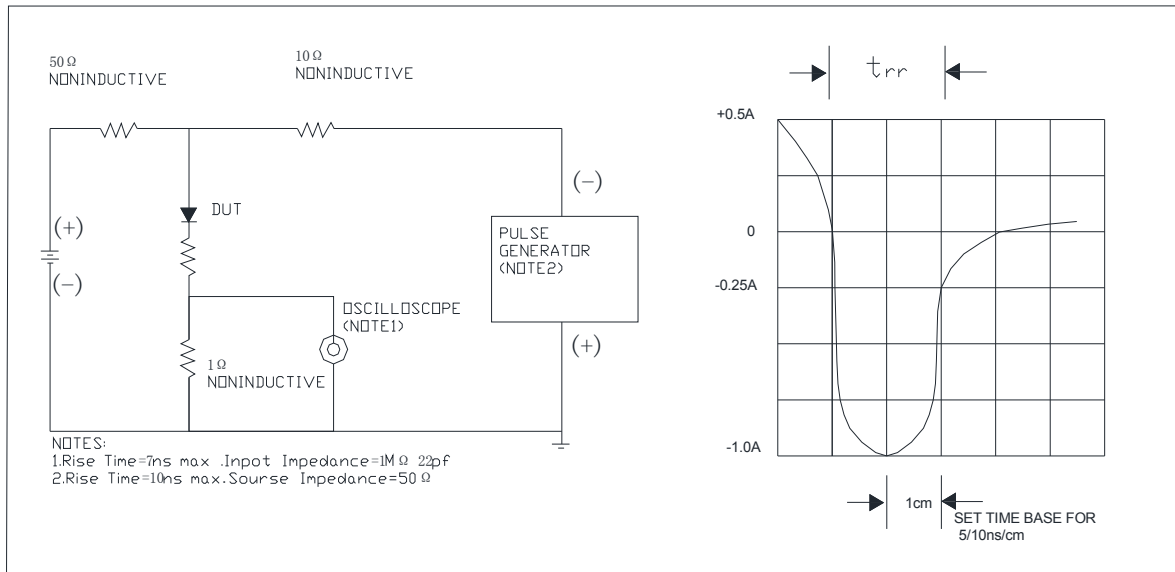
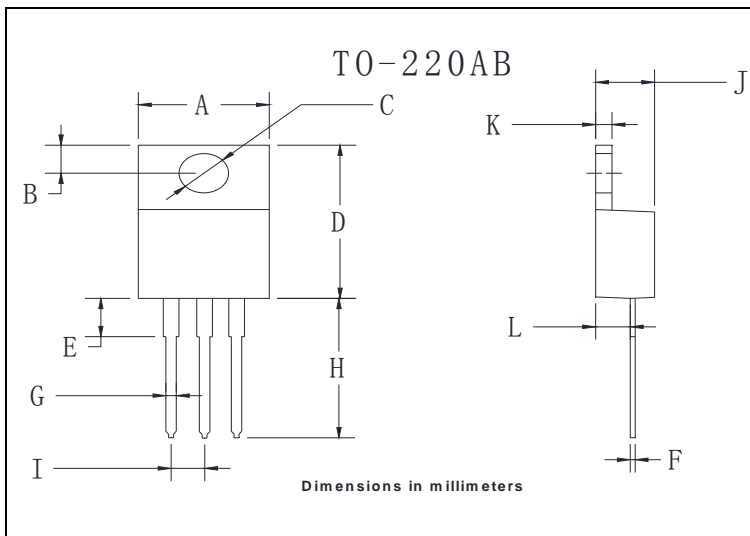

FIG.5 Diagram of circuit and Testing wave form of reverse recovery time



Outline Dimensions



TO-220AB		
Dim	Min	Max
A	9.5	10.9
B	2.22	3.27
C	3.34	4.31
D	14.5	15.5
E	3.16	4.46
F	0.28	0.64
G	0.68	0.94
H	13.06	14.62
I	2.01	3.07
J	4.04	5.1
K	1.14	1.4
L	2.14	3.19



Disclaimer

The information presented in this document is for reference only. Yangzhou Yangjie Electronic Technology Co., Ltd. reserves the right to make changes without notice for the specification of the products displayed herein to improve reliability, function or design or otherwise.

The product listed herein is designed to be used with ordinary electronic equipment or devices, and not designed to be used with equipment or devices which require high level of reliability and the malfunction of which would directly endanger human life (such as medical instruments, transportation equipment, aerospace machinery, nuclear-reactor controllers, fuel controllers and other safety devices), Yangjie or anyone on its behalf, assumes no responsibility or liability for any damages resulting from such improper use of sale.

This publication supersedes & replaces all information previously supplied. For additional information, please visit our website [http:// www.21yangjie.com](http://www.21yangjie.com) , or consult your nearest Yangjie's sales office for further assistance.