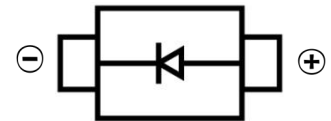

SCHOTTKY BARRIER DIODE
FEATURES

- Low Forward Voltage
- High conductance
- Small Surface Mount device
- PN Junction Guard Ring for Transient and ESD Protection

SOD-123
MECHANICAL DATA

- Case: SOD-123
- Case Material: Molded Plastic. UL flammability
- Classification Rating: 94V-0
- Weight: 0.005 grams (approximate)

MAXIMUM RATINGS (T_A = 25°C unless otherwise noted)

Parameter	Symbol	MBR0520L	MBR0530L	MBR0540L	Unit
Peak Reverse Voltage	V _R	20	30	40	V
RMS Reverse Voltage	V _{R(RMS)}	14	21	28	
Maximum DC Blocking Voltage	V _{RM}	20	30	40	
Average rectified output current	I _o	500			mA
Non-Repetitive Peak Forward Surge Current@t=8.3ms	I _{FSM}	5.5			A
Power Dissipation	P _D	410			mW
Thermal Resistance From Junction To Ambient	R _{θJA}	305			°C/W
Junction Temperature	T _J	125			°C
Storage Temperature	T _{STG}	-55 ~+150			°C

ELECTRICAL CHARACTERISTICS (T_A = 25°C unless otherwise specified)

Parameter	Symbol	MBR0520L	MBR0530L	MBR0540L	Unit	Conditions
Maximum Forward voltage	V _F	0.300	0.375	0.510	V	I _F =100mA
		0.385	0.430	0.620		I _F =500mA
Minimum Reverse voltage	V _R	20	30	40	V	I=I _R
Maximum Reverse voltage leakage current@Rated DC Blocking Voltage	I _R	75	20	10	μA	V=1/2V _R
		250	130	20		V=V _R
Typical Junction capacitance	C _J	170			pF	V _R =0V,f=1MHz

MARKING:

MBR0520L	MBR0530L	MBR0540L
SD	SE	SF

SCHOTTKY BARRIER DIODE

Typical Characteristics

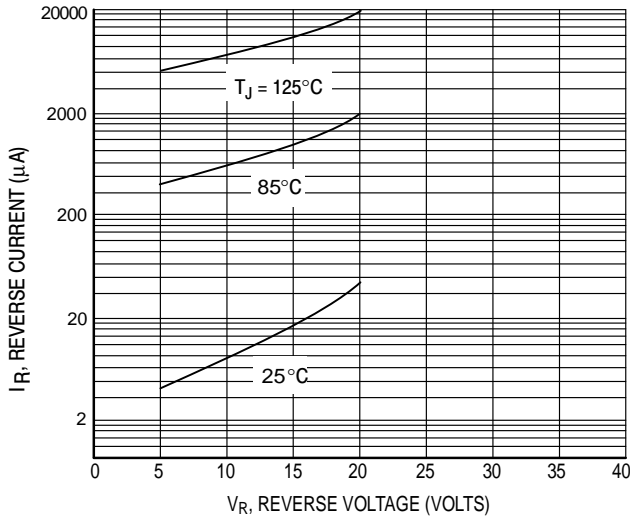

Figure 1. Typical Reverse Current of MBR0520L

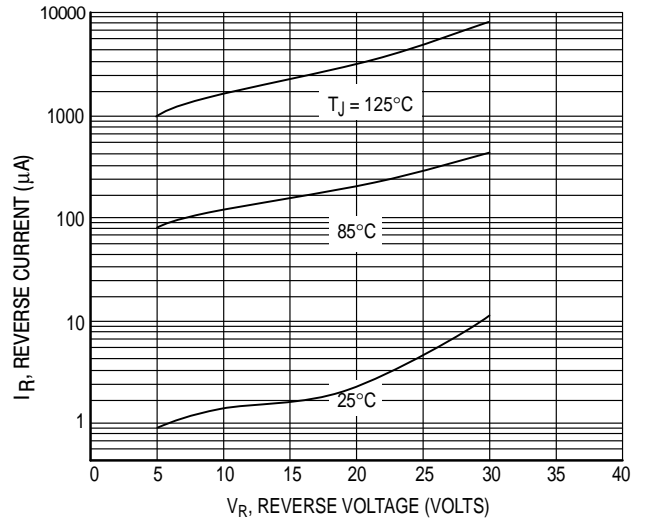

Figure 2. Typical Reverse Current of MBR0530L

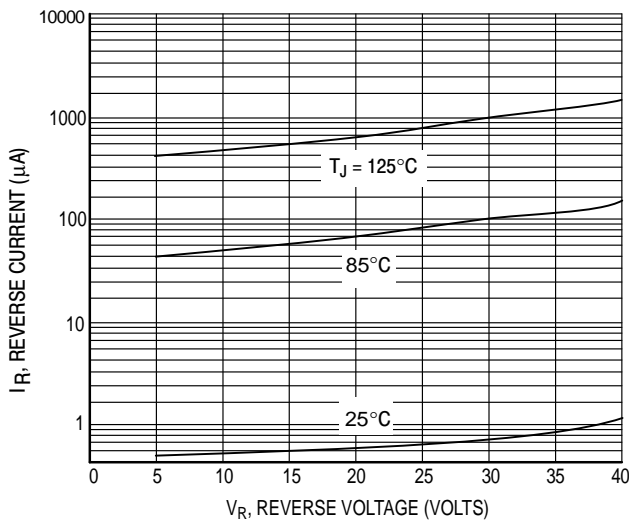
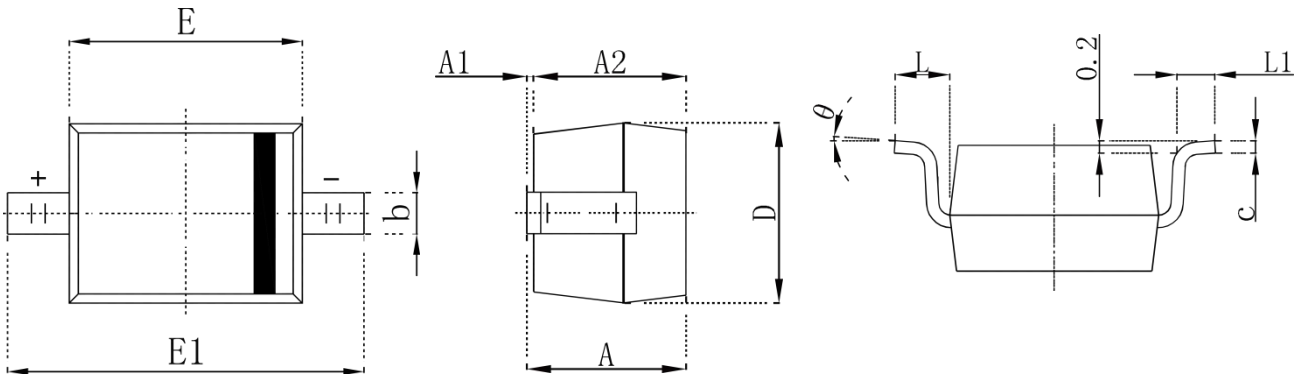

Figure 3. Typical Reverse Current of MBR0540L

SCHOTTKY BARRIER DIODE

SOD-123 Package Outline Dimensions



Symbol	Dimensions In Millimeters		Dimensions In Inches	
	Min.	Max.	Min.	Max.
A	1.050	1.250	0.041	0.049
A1	0.000	0.100	0.000	0.004
A2	1.050	1.150	0.041	0.045
b	0.450	0.650	0.018	0.026
c	0.080	0.150	0.003	0.006
D	1.500	1.700	0.059	0.067
E	2.600	2.800	0.102	0.110
E1	3.550	3.850	0.140	0.152
L	0.500REF		0.020 REF	
L1	0.250	0.450	0.010	0.018
θ	0°	8°	0°	8°

SOD-123 Suggested Pad Layout

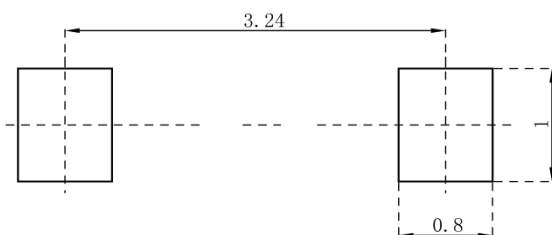

Note:

1. Controlling dimension: in millimeters
2. General tolerance: $\pm 0.05\text{mm}$
3. The pad layout is for reference purposes only

SCHOTTKY BARRIER DIODE

SOD-123 Tape and Reel

SOD-123 Embossed Carrier Tape

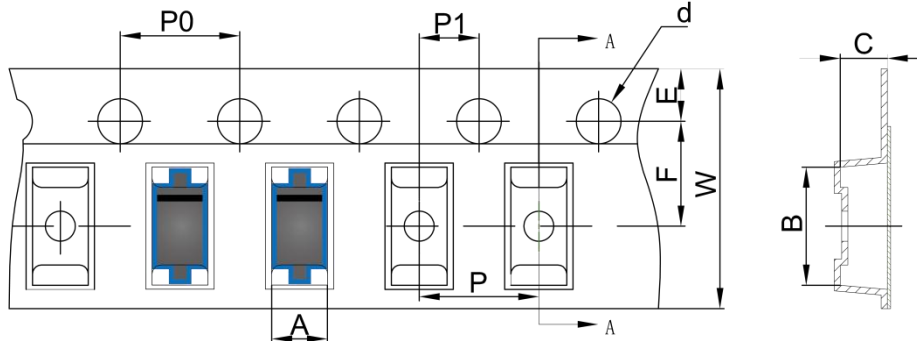

SOD-123 Tape Leader and Trailer

DIMENSIONS ARE IN MILLIMETER										
TYPE	A	B	C	d	E	F	P0	P	P1	W
SOD-123	1.85	3.95	1.57	Ø1.55	1.75	3.50	4.00	4.00	2.00	8.00
TOLERANCE	±0.1	±0.1	±0.1	±0.1	±0.1	±0.1	±0.1	±0.1	±0.1	±0.1

SOD-123 Reel

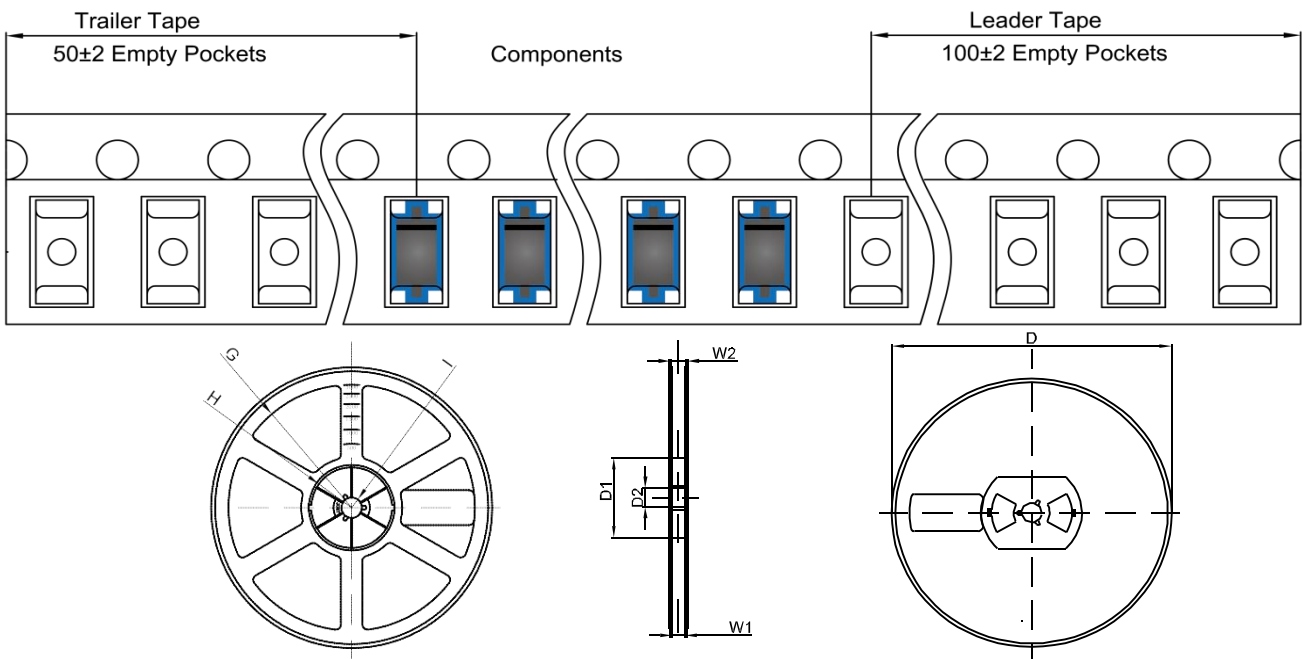

DIMENSIONS ARE IN MILLIMETER								
REEL OPTION	D	D1	D2	G	H	I	W1	W2
7" DIA	Ø178	54.40	13.00	R78	R25.60	R6.50	9.50	12.30
TOLERANCE	±2	±1	±1	±1	±1	±1	±1	±1