



Ultra-Fast Avalanche Sinterglass Diode



949539

FEATURES

- Glass passivated junction
• Hermetically sealed package
• Very low switching losses
• Low reverse current
• High reverse voltage
• Material categorization:
For definitions of compliance please see
www.vishay.com/doc?99912



RoHS COMPLIANT HALOGEN FREE

MECHANICAL DATA

Case: SOD-57

Terminals: plated axial leads, solderable per MIL-STD-750, method 2026

Polarity: color band denotes cathode end

Mounting position: any

Weight: approx. 369 mg

APPLICATIONS

- Switched mode power supplies
• High-frequency inverter circuits

ORDERING INFORMATION (Example)

Table with 4 columns: DEVICE NAME, ORDERING CODE, TAPED UNITS, MINIMUM ORDER QUANTITY. Rows for BYV26E (TR and TAP).

PARTS TABLE

Table with 3 columns: PART, TYPE DIFFERENTIATION, PACKAGE. Rows for BYV26A through BYV26E.

ABSOLUTE MAXIMUM RATINGS (Tamb = 25 °C, unless otherwise specified)

Table with 6 columns: PARAMETER, TEST CONDITION, PART, SYMBOL, VALUE, UNIT. Rows for Reverse voltage, Peak forward surge current, Average forward current, Non repetitive reverse avalanche energy, Junction and storage temperature range.

MAXIMUM THERMAL RESISTANCE (Tamb = 25 °C, unless otherwise specified)

Table with 5 columns: PARAMETER, TEST CONDITION, SYMBOL, VALUE, UNIT. Row for Junction ambient.



ELECTRICAL CHARACTERISTICS ($T_{amb} = 25\text{ }^{\circ}\text{C}$, unless otherwise specified)							
PARAMETER	TEST CONDITION	PART	SYMBOL	MIN.	TYP.	MAX.	UNIT
Forward voltage	$I_F = 1\text{ A}$		V_F	-	-	2.5	V
	$I_F = 1\text{ A}, T_j = 175\text{ }^{\circ}\text{C}$		V_F	-	-	1.3	V
Reverse current	$V_R = V_{RRM}$		I_R	-	-	5	μA
	$V_R = V_{RRM}, T_j = 150\text{ }^{\circ}\text{C}$		I_R	-	-	100	μA
Reverse breakdown voltage	$I_R = 100\text{ }\mu\text{A}$	BYV26A	$V_{(BR)R}$	300	-	-	V
		BYV26B	$V_{(BR)R}$	500	-	-	V
		BYV26C	$V_{(BR)R}$	700	-	-	V
		BYV26D	$V_{(BR)R}$	900	-	-	V
		BYV26E	$V_{(BR)R}$	1100	-	-	V
Reverse recovery time	$I_F = 0.5\text{ A}, I_R = 1\text{ A}, I_R = 0.25\text{ A}$	BYV26A	t_{rr}	-	-	30	ns
		BYV26B	t_{rr}	-	-	30	ns
		BYV26C	t_{rr}	-	-	30	ns
		BYV26D	t_{rr}	-	-	75	ns
		BYV26E	t_{rr}	-	-	75	ns

TYPICAL CHARACTERISTICS ($T_{amb} = 25\text{ }^{\circ}\text{C}$, unless otherwise specified)

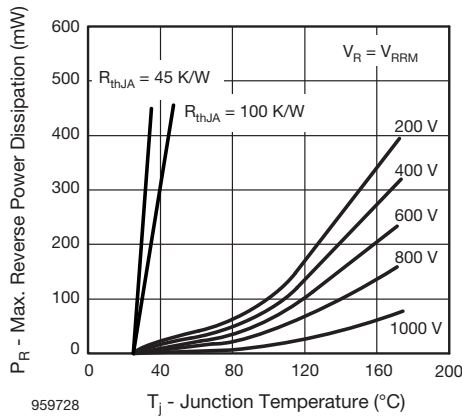

Fig. 1 - Max. Reverse Power Dissipation vs. Junction Temperature

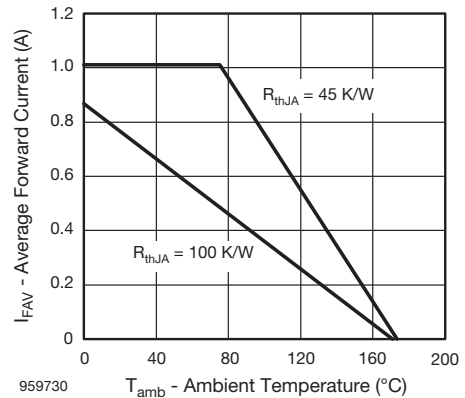

Fig. 3 - Max. Average Forward Current vs. Ambient Temperature

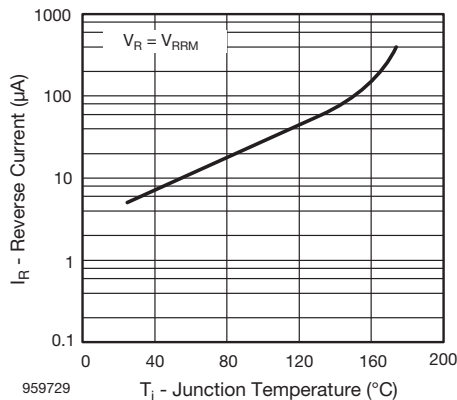

Fig. 2 - Max. Reverse Current vs. Junction Temperature

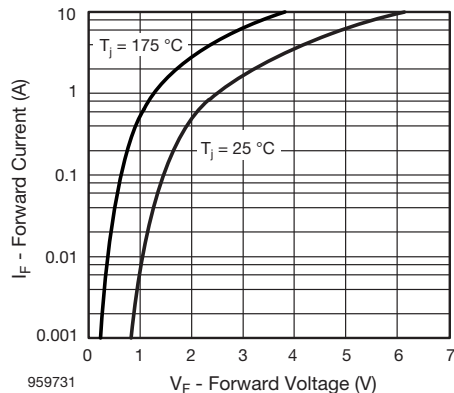

Fig. 4 - Max. Forward Current vs. Junction Temperature

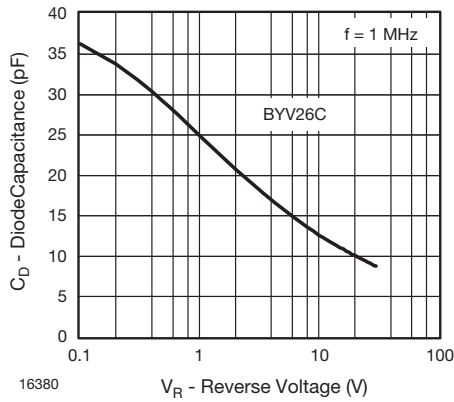

Fig. 5 - Diode Capacitance vs. Reverse Voltage

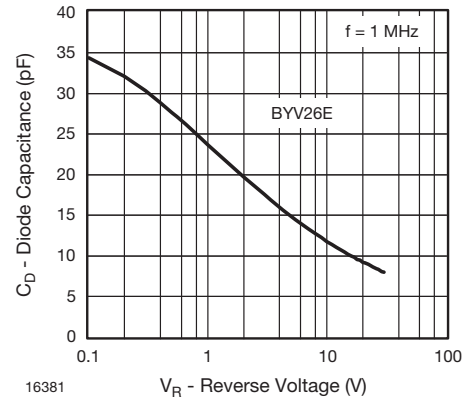
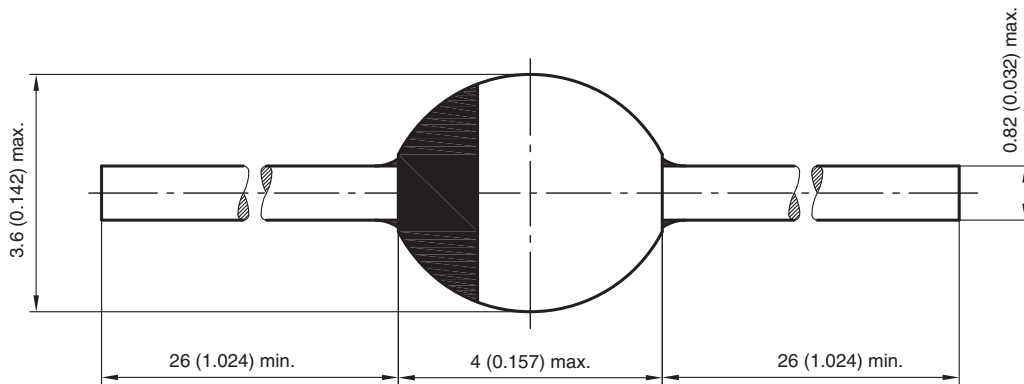

Fig. 6 - Diode Capacitance vs. Reverse Voltage

PACKAGE DIMENSIONS in millimeters (inches): **SOD-57**



20543
 Rev. 3 - Date: 09.February 2005
 Document no.:6.563-5006.3-4



Disclaimer

ALL PRODUCT, PRODUCT SPECIFICATIONS AND DATA ARE SUBJECT TO CHANGE WITHOUT NOTICE TO IMPROVE RELIABILITY, FUNCTION OR DESIGN OR OTHERWISE.

Vishay Intertechnology, Inc., its affiliates, agents, and employees, and all persons acting on its or their behalf (collectively, "Vishay"), disclaim any and all liability for any errors, inaccuracies or incompleteness contained in any datasheet or in any other disclosure relating to any product.

Vishay makes no warranty, representation or guarantee regarding the suitability of the products for any particular purpose or the continuing production of any product. To the maximum extent permitted by applicable law, Vishay disclaims (i) any and all liability arising out of the application or use of any product, (ii) any and all liability, including without limitation special, consequential or incidental damages, and (iii) any and all implied warranties, including warranties of fitness for particular purpose, non-infringement and merchantability.

Statements regarding the suitability of products for certain types of applications are based on Vishay's knowledge of typical requirements that are often placed on Vishay products in generic applications. Such statements are not binding statements about the suitability of products for a particular application. It is the customer's responsibility to validate that a particular product with the properties described in the product specification is suitable for use in a particular application. Parameters provided in datasheets and / or specifications may vary in different applications and performance may vary over time. All operating parameters, including typical parameters, must be validated for each customer application by the customer's technical experts. Product specifications do not expand or otherwise modify Vishay's terms and conditions of purchase, including but not limited to the warranty expressed therein.

Except as expressly indicated in writing, Vishay products are not designed for use in medical, life-saving, or life-sustaining applications or for any other application in which the failure of the Vishay product could result in personal injury or death. Customers using or selling Vishay products not expressly indicated for use in such applications do so at their own risk. Please contact authorized Vishay personnel to obtain written terms and conditions regarding products designed for such applications.

No license, express or implied, by estoppel or otherwise, to any intellectual property rights is granted by this document or by any conduct of Vishay. Product names and markings noted herein may be trademarks of their respective owners.

Mouser Electronics

Authorized Distributor

Click to View Pricing, Inventory, Delivery & Lifecycle Information:

[Vishay:](#)

[BYV26DGP-E3/23](#) [BYV26DGP-E3/4](#) [BYV26DGPHE3/54](#) [BYV26DGPHE3/73](#) [BYV26EGP-E3/23](#) [BYV26EGP-E3/4](#)
[BYV26EGPHE3/54](#) [BYV26EGPHE3/73](#) [BYV26E-E3/54](#) [BYV26DGP-E3/1](#) [BYV26D-E3/54](#) [BYV26EGP-E3/1](#)
[BYV26A-TR](#) [BYV26B-TR](#) [BYV26C-TR](#) [BYV26D-TR](#) [BYV26D/4](#) [BYV26E/4](#) [BYV26C-TAP](#) [BYV26E-TR](#) [BYV26A-](#)
[TAP](#) [BYV26B-TAP](#) [BYV26D-TAP](#) [BYV26E-TAP](#)