

Kingtronics®

DKT-DZ

Radial, Snap-in, Screw Super Capacitor

FEATURES

- ◆ Radial type, Snap-in type, Screw Type terminals
- ◆ High energy and high power
- ◆ Low ESR
- ◆ Pb-free and RoHS compliant

APPLICATIONS

- ◆ RAM, Detonator, car recorder, smart meter, vacuum switch, digital camera, motor drive, clock circuit, UPS, toy, program-controlled switch, etc.



SPECIFICATIONS

Series name	DKT-DZ Series High power type	
Type name	DKT-DZ 2R7	DKT-DZ 3R0
Rated voltage V_R	2.7V	3.0V
Surge voltage	2.85V	3.15V
Capacity range	0.1F~3000F	1F~500F
Operating temperature range	-40~ +70°C	-40~ +65°C
Product life	Normal temperature cycle life : 25°C, 1 million cycles between V_R and $1/2V_R$, Capacity attenuation $\leq 30\%$, ESR change ≤ 4 times. High temperature endurance life : Maximum temperature retention V_R · 1000 hours. Capacity attenuation $\leq 30\%$, ESR change ≤ 4 times.	

DIMENSIONS (mm)

0.1-120F

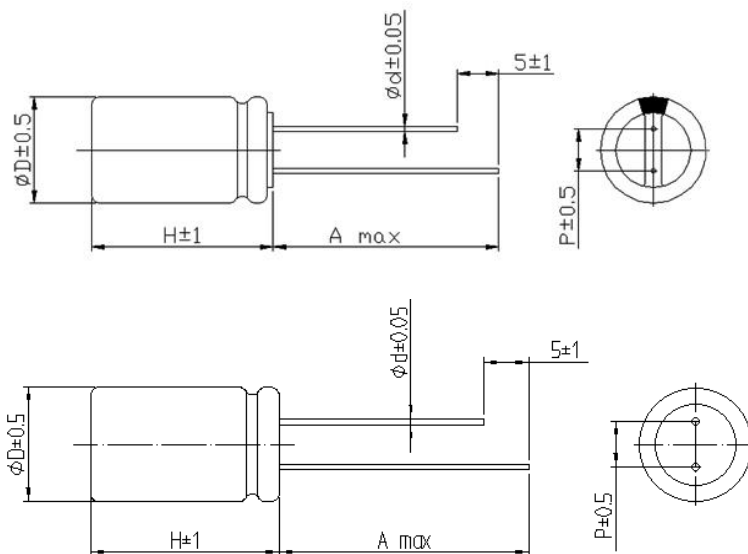

Kingtronics® International Company

Kingtronics®

DKT-DZ

Radial, Snap-in, Screw Super Capacitor

DIMENSIONS (mm)

90-700F

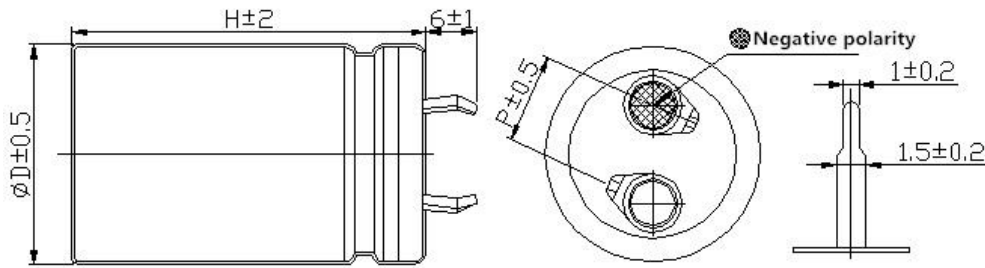

350F

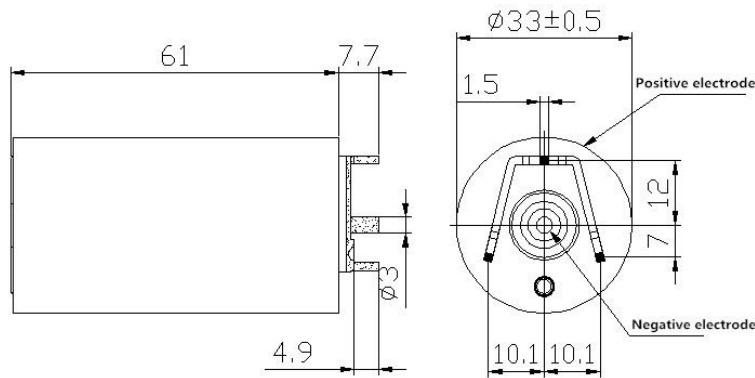

3000F

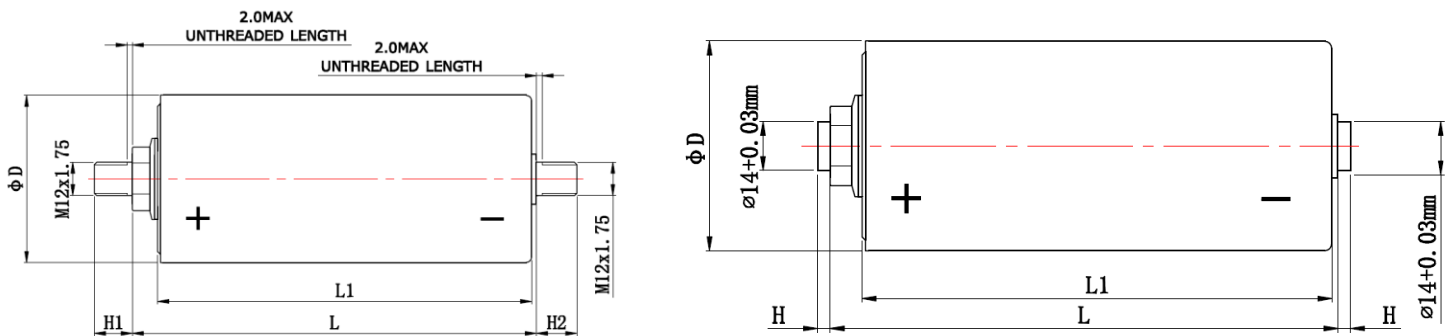

Kingtronics® International Company

Kingtronics®

DKT-DZ

Radial, Snap-in, Screw Super Capacitor

DIMENSIONS (mm)

650F~800F bolt series product size specifications

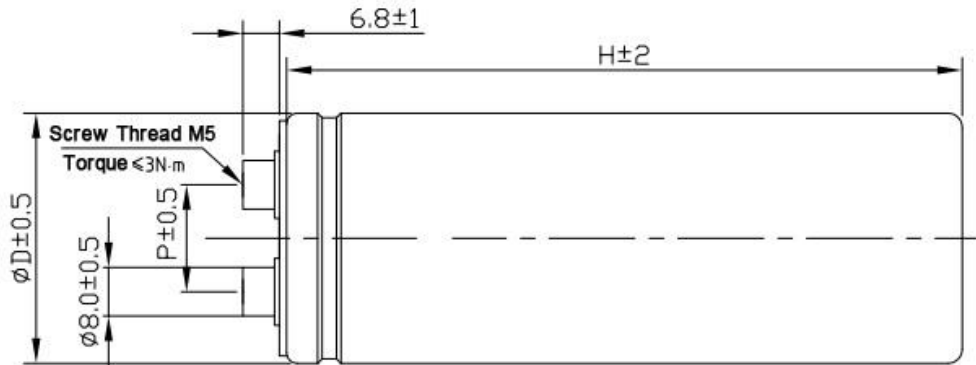

1000F~2400F bolt series product size specifications

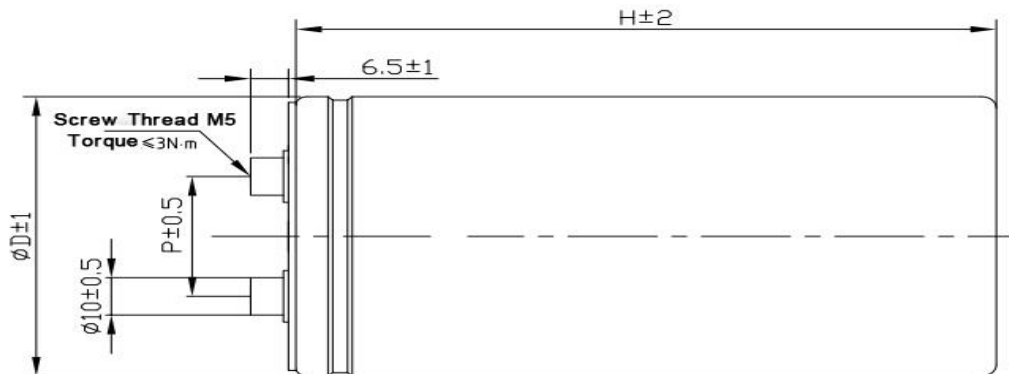

3000F bolt series product size specifications

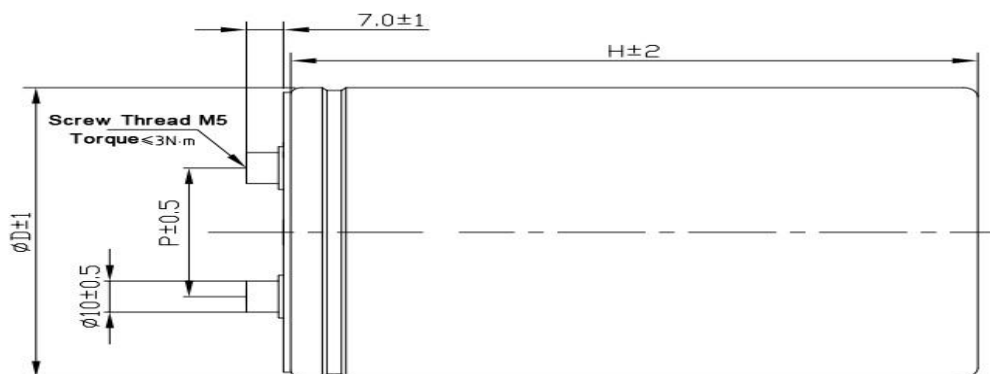

Kingtronics® International Company

Kingtronics®**DKT-DZ**

Radial, Snap-in, Screw Super Capacitor

STANDARD RATINGS

Capacity (F)	ESR mΩ		Product size (mm)			Terminals
	DC	AC 1kHz	Diameter	Height	Pin distance	
Rated voltage: 2.7V						
0.1	675	450	5	12	2	Radial Type
0.15	600	400	5	12	2	Radial Type
0.22	750	500	5	12	2	Radial Type
0.25	750	500	5	12	2	Radial Type
0.25	750	500	6.3	12	2.5	Radial Type
0.35	600	400	5	12	2	Radial Type
0.5	700	350	6.3	10	2.5	Radial Type
0.5	750	500	5	12	2	Radial Type
0.5	750	500	6.3	12	2.5	Radial Type
0.7	600	300	6.3	10	2.5	Radial Type
0.7	600	300	8	12	3.5	Radial Type
0.7	600	400	8	13	3.5	Radial Type
1	300	150	6.3	12	2.5	Radial Type
1	300	150	6.3	10	2.5	Radial Type
1	300	150	8	12	3.5	Radial Type
1	300	200	8	19	3.5	Radial Type
1	450	300	6.3	12	2.5	Radial Type
1	450	300	8	13	3.5	Radial Type
1.5	300	150	6.3	12	2.5	Radial Type
2	200	100	6.3	22	2.5	Radial Type
2	200	100	8	12	3.5	Radial Type
2	200	100	8	15	3.5	Radial Type
2	200	100	8	19	3.5	Radial Type
2	210	140	8	13	3.5	Radial Type
2	210	140	8	19	3.5	Radial Type
2	210	140	10	20	5	Radial Type
3	130	65	8	16	3.5	Radial Type
3	130	65	8	19	3.5	Radial Type
3	150	100	8	19	3.5	Radial Type
3	180	120	8	16	3.5	Radial Type
3	200	100	6.3	22	2.5	Radial Type

Kingtronics® International CompanyWebsite: www.kingtronics.com Email: info@kingtronics.com Tel: (852) 8106 7033 Fax: (852) 8106 7099

Kingtronics®**DKT-DZ**

Radial, Snap-in, Screw Super Capacitor

STANDARD RATINGS

Capacity (F)	ESR (mΩ)		Product size (mm)			Terminals
	DC	AC 1kHz	Diameter	Height	Pin distance	
Rated voltage: 2.7V						
3.3	120	80	10	20	5	Radial Type
3.3	130	65	8	19	3.5	Radial Type
3.3	150	100	10	16	5	Radial Type
3.3	160	80	6.3	22	2.5	Radial Type
3.3	180	120	8	19	3.5	Radial Type
4	120	80	10	20	5	Radial Type
4	200	100	8	20	3.5	Radial Type
4.7	90	45	8	24	3.5	Radial Type
4.7	105	70	12.5	21	5	Radial Type
4.7	120	80	10	20	5	Radial Type
5	90	45	8	24	3.5	Radial Type
5	90	45	10	20	5	Radial Type
5	105	70	12.5	21	5	Radial Type
6	90	45	8	24	3.5	Radial Type
6	90	45	10	20	5	Radial Type
6	105	70	12.5	21	5	Radial Type
7	70	35	10	25	5	Radial Type
7	105	70	10	25	5	Radial Type
8	70	35	10	20	5	Radial Type
8	75	50	12.5	21	5	Radial Type
8	100	50	12.5	21	5	Radial Type
10	64	32	10	25	5	Radial Type
10	64	32	12.5	21	5	Radial Type
10	64	32	12.5	25	5	Radial Type
10	75	50	10	30	5	Radial Type
10	75	50	12.5	26	5	Radial Type
10	90	60	12.5	21	5	Radial Type
12	64	32	12.5	21	5	Radial Type
12	64	32	12.5	26	5	Radial Type
12	75	50	12.5	26	5	Radial Type
15	45	30	16	26	7.5	Radial Type

Kingtronics® International CompanyWebsite: www.kingtronics.com Email: info@kingtronics.com Tel: (852) 8106 7033 Fax: (852) 8106 7099

Kingtronics®**DKT-DZ**

Radial, Snap-in, Screw Super Capacitor

STANDARD RATINGS

Capacity (F)	ESR (mΩ)			Product size (mm)			Terminals
	DC	AC	1kHz	Diameter	Height	Pin distance	
Rated voltage: 2.7V							
15	60	30		12.5	25	5	Radial Type
16	60	30		12.5	25	5	Radial Type
18	60	30		12.5	26	5	Radial Type
20	37.5	25		16	26	7.5	Radial Type
20	50	25		12.5	25	5	Radial Type
20	50	25		12.5	30	5	Radial Type
22	37.5	25		16	26	7.5	Radial Type
22	50	25		12.5	30	5	Radial Type
25	37.5	25		16	26	7.5	Radial Type
25	50	25		12.5	30	5	Radial Type
30	37.5	25		16	34	7.5	Radial Type
30	44	22		12.5	30	5	Radial Type
40	30	20		18	41	8	Radial Type
50	30	20		18	41	8	Radial Type
50	40	20		18	41	8	Radial Type
60	16	14		22.4	45.5	10	Snap-in Type
60	22.5	15		18	41	8	Radial Type
60	40	20		18	41	8	Radial Type
70	22.5	15		18	52	8	Radial Type
100	14	12		22.4	45.5	10	Snap-in Type
100	30	20		18	45	8	Radial Type
120	14	12		22.4	45.5	10	Snap-in Type
150	14	12		25.2	52.5	10	Snap-in Type
200	11	10		35.6	61.5	10	Snap-in Type
220	11	10		30	50	10	Snap-in Type
300	9	8		35.6	61.5	10	Snap-in Type
360	9	8		35.6	61.5	10	Snap-in Type
400	9	8		35.6	61.5	10	Snap-in Type
470	8	6		35.6	61.5	10	Snap-in Type
3000	0.28	0.25		60	138.6	/	Screw Type

Kingtronics® International CompanyWebsite: www.kingtronics.comEmail: info@kingtronics.com

Tel: (852) 8106 7033

Fax: (852) 8106 7099

Kingtronics®**DKT-DZ**

Radial, Snap-in, Screw Super Capacitor

STANDARD RATINGS

Capacity (F)	ESR (mΩ)			Product size (mm)			Terminals
	DC	AC	1kHz	Diameter	Height	Pin distance	
Rated voltage: 3.0V							
1	300	150		8	12	3.5	Radial Type
1	450	300		8	13	3.5	Radial Type
2	200	100		8	12	3.5	Radial Type
2	200	100		8	19	3.5	Radial Type
2	210	140		8	13	3.5	Radial Type
2	210	140		8	19	3.5	Radial Type
3	130	65		8	19	3.5	Radial Type
3	150	100		8	19	3.5	Radial Type
3.3	120	80		8	19	3.5	Radial Type
3.3	120	80		10	20	5	Radial Type
3.3	130	65		8	19	3.5	Radial Type
4.7	105	70		10	20	5	Radial Type
4.7	120	80		10	20	5	Radial Type
5	90	45		10	20	5	Radial Type
5	105	70		10	20	5	Radial Type
10	55	35		10	25	5	Radial Type
10	64	32		10	25	5	Radial Type
15	45	30		12.5	26	5	Radial Type
15	60	30		12.5	25	5	Radial Type
25	30	20		18	42	7.5	Radial Type
25	50	25		12.5	30	5	Radial Type
50	22.5	15		18	42	7.5	Radial Type
50	40	20		18	41	8	Radial Type
60	22.5	15		18	42	7.5	Radial Type
60	40	20		18	41	8	Radial Type
100	14	12		22.5	46	10	Snap-in Type
120	14	12		22.5	46	10	Snap-in Type
150	12	10		25.2	52.5	10	Snap-in Type
360	9	8		35.6	61.5	10	Snap-in Type
400	9	8		35.6	61.5	10	Snap-in Type
470	8	6		35.6	61.5	10	Snap-in Type

Kingtronics® International CompanyWebsite: www.kingtronics.comEmail: info@kingtronics.com

Tel: (852) 8106 7033

Fax: (852) 8106 7099

Kingtronics®

DKT-DZ

Radial, Snap-in, Screw Super Capacitor

HOW TO ORDER

DKT	DZ	2R7	104	M	00500120	020	000	R	B	R
Series	Sub Series	Voltage	Capacity	Capacity Tolerance	Dimension	Pitch/Pins	Lead Length	Terminal Options	Packing	Pb
		1.	2.	3.	4.	5.	6.	7.	8.	9.

NOTE:

1. Voltage

Code	2R7	3R0
Voltage	2.7	3.0

2. Capacity

Code	104	105	106	107	108
Capacitance (F)	0.1	1.0	10	100	1000

3. Capacity Tolerance

Code	M	V	F
Tolerance	±20%	-10%~+20%	0%~+30%

4. Dimension

Code	00500120	00630125	01000200	01250210	01600260	05101080
Dimension (mm)	5x12	6.3x12.5	10x20	12.5x21	16x26	51x108

5. Pitch/Pins/Screw

Code	016	020	025	035	050	075	100	127	218	282	4PS
Pitch (mm)/Pins	1.6	2.0	2.5	3.5	5.0	7.5	10.0	12.7	21.8	28.2	4pins
Code	000										
Pitch (mm)	Screw										

6. Lead Length

Code	000	040	045	050
Lead Length	Standard	4.0	4.5	5.0

7. Terminal Options

Code	R	S	W
Terminal Options	Radial	Snap-in	Screw

8. Packing

Code	A	B
Packing	Ammo	Bulk

9. Pb

Code	L	R
Pb	Leaded	RoHS

Note: Specifications are subject to change without notice.

Kingtronics® International Company

Website: www.kingtronics.com

Email: info@kingtronics.com

Tel: (852) 8106 7033

Fax: (852) 8106 7099