

GigaDevice Semiconductor Inc.

GD32F107xx
ARM[®] Cortex[™]-M3 32-bit MCU

Datasheet

Table of Contents

List of Figures	3
List of Tables	4
1 General description	5
2 Device overview	6
2.1 Device information	6
2.2 Block diagram.....	8
2.3 Pinouts and pin assignment	9
2.4 Memory map.....	12
2.5 Clock tree	13
2.6 Pin definitions	14
3 Functional description	22
3.1 ARM [®] Cortex [™] -M3 core	22
3.2 On-chip memory.....	22
3.3 Clock, reset and supply management	23
3.4 Boot modes.....	23
3.5 Power saving modes	24
3.6 Analog to digital converter (ADC).....	24
3.7 Digital to analog converter (DAC).....	25
3.8 DMA	25
3.9 General-purpose inputs/outputs (GPIOs).....	25
3.10 Timers and PWM generation.....	26
3.11 Real time clock (RTC)	27
3.12 Inter-integrated circuit (I2C).....	27
3.13 Serial peripheral interface (SPI).....	28
3.14 Universal synchronous asynchronous receiver transmitter (USART).....	28
3.15 Inter-IC sound (I2S)	28
3.16 Universal serial bus on-the-go full-speed (USB OTG FS)	29
3.17 Controller area network (CAN).....	29
3.18 Ethernet MAC interface.....	29
3.19 External memory controller (EXMC)	30
3.20 Debug mode	30
3.21 Package and operation temperature.....	30
4 Electrical characteristics	31
4.1 Absolute maximum ratings	31
4.2 Recommended DC characteristics.....	31
4.3 Power consumption	32
4.4 EMC characteristics.....	33
4.5 Power supply supervisor characteristics	33

4.6	Electrical sensitivity.....	34
4.7	External clock characteristics.....	34
4.8	Internal clock characteristics	35
4.9	PLL characteristics	36
4.10	Memory characteristics	36
4.11	GPIO characteristics.....	36
4.12	ADC characteristics	37
4.13	DAC characteristics	37
4.14	I2C characteristics	37
4.15	SPI characteristics	38
5	Package information	39
6	Ordering Information.....	41
7	Revision History.....	42

List of Figures

Figure 1. GD32F107xx block diagram.....	8
Figure 2. GD32F107Zx LQFP144 pinouts	9
Figure 3. GD32F107Vx LQFP100 pinouts	10
Figure 4. GD32F107Rx LQFP64 pinouts.....	11
Figure 6. GD32F107xx memory map	12
Figure 7. GD32F107xx clock tree.....	13
Figure 8. LQFP package outline.....	39

List of Tables

Table 1. GD32F107xx devices features and peripheral list.....	6
Table 2. GD32F107xx pin definitions	14
Table 3. Absolute maximum ratings	31
Table 4. DC operating conditions	31
Table 5. Power consumption characteristics	32
Table 6. EMS characteristics	33
Table 7. EMI characteristics.....	33
Table 8. Power supply supervisor characteristics.....	33
Table 9. ESD characteristics.....	34
Table 10. Static latch-up characteristics	34
Table 11. High speed external clock (HSE) generated from a crystal/ceramic characteristics	34
Table 12. Low speed external clock (LSE) generated from a crystal/ceramic characteristics	35
Table 13. High speed internal clock (HSI) characteristics	35
Table 14. Low speed internal clock (LSI) characteristics.....	35
Table 15. PLL characteristics	36
Table 16. Flash memory characteristics	36
Table 17. I/O port characteristics.....	36
Table 18. ADC characteristics.....	37
Table 19. DAC characteristics	37
Table 20. I2C characteristics.....	37
Table 21. SPI characteristics.....	38
Table 22. LQFP package dimensions	40
Table 23. Part ordering code for GD32F107xx devices	41
Table 24. Revision history.....	42

1 General description

The GD32F107xx device belongs to the connectivity line of GD32 MCU Family. It is a 32-bit general-purpose microcontroller based on the ARM[®] Cortex[™]-M3 RISC core with enhanced connectivity performance and best ratio in terms of processing power, reduced power consumption and peripheral set. The Cortex[™]-M3 is a next generation processor core which is tightly coupled with a Nested Vectored Interrupt Controller (NVIC), SysTick timer and advanced debug support.

The GD32F107xx device incorporates the ARM[®] Cortex[™]-M3 32-bit processor core operating at 108 MHz frequency with Flash accesses zero wait states to obtain maximum efficiency. It provides up to 1 MB on-chip Flash memory and 96 KB SRAM memory. An extensive range of enhanced I/Os and peripherals connected to two APB buses. The devices offer up to three 12-bit ADCs, up to two 12-bit DACs, up to ten general-purpose 16-bit timers, two basic timers plus two PWM advanced-control timer, as well as standard and advanced communication interfaces: up to three SPIs, two I²Cs, three USARTs, two UARTs, two I²Ss, two CANs, an USB OTG FS and an Ethernet MAC.

The device operates from a 2.6 to 3.6 V power supply and available in –40 to +85 °C temperature range. Several power saving modes provide the flexibility for maximum optimization between wakeup latency and power consumption, an especially important consideration in low power applications.

The above features make the GD32F107xx devices suitable for a wide range of interconnection applications, especially in areas such as industrial control, motor drives, power monitor and alarm systems, consumer and handheld equipment, POS, vehicle GPS, LED display and so on.

2 Device overview

2.1 Device information

Table 1. GD32F107xx devices features and peripheral list

Part Number		GD32F107xx							
		RB	RC	RD	RE	RF	RG	VB	VC
Flash (KB)		128	256	384	512	768	1024	128	256
SRAM (KB)		96	96	96	96	96	96	96	96
Timers	GPTM	4	4	4	4	10	10	4	4
	Advanced TM	1	1	2	2	2	2	1	1
	SysTick	1	1	1	1	1	1	1	1
	Basic TM	2	2	2	2	2	2	2	2
	Watchdog	2	2	2	2	2	2	2	2
	RTC	1	1	1	1	1	1	1	1
Connectivity	U(S)ART	5	5	5	5	5	5	5	5
	I2C	2	2	2	2	2	2	2	2
	SPI	3	3	3	3	3	3	3	3
	I2S	2	2	2	2	2	2	2	2
	CAN 2.0B	2	2	2	2	2	2	2	2
	USB OTG FS	1	1	1	1	1	1	1	1
	Ethernet MAC	1	1	1	1	1	1	1	1
GPIO		51	51	51	51	51	51	80	80
EXMC		0	0	0	0	0	0	1	1
EXTI		16	16	16	16	16	16	16	16
ADC	Units	3	3	3	3	3	3	3	3
	Channels	16	16	16	16	16	16	16	16
DAC		2	2	2	2	2	2	2	2
Package		LQFP64					LQFP100		

Table 1. GD32F107xx devices features and peripheral list (continued)

Part Number		GD32F107xx								
		VD	VE	VF	VG	ZC	ZD	ZE	ZF	ZG
Flash (KB)		384	512	768	1024	256	384	512	768	1024
SRAM (KB)		96	96	96	96	96	96	96	96	96
Timers	GPTM	4	4	10	10	4	4	4	10	10
	Advanced TM	2	2	2	2	2	2	2	2	2
	SysTick	1	1	1	1	1	1	1	1	1
	Basic TM	2	2	2	2	2	2	2	2	2
	Watchdog	2	2	2	2	2	2	2	2	2
	RTC	1	1	1	1	1	1	1	1	1
Connectivity	U(S)ART	5	5	5	5	5	5	5	5	5
	I2C	2	2	2	2	2	2	2	2	2
	SPI	3	3	3	3	3	3	3	3	3
	I2S	2	2	2	2	2	2	2	2	2
	CAN 2.0B	2	2	2	2	2	2	2	2	2
	USB OTG FS	1	1	1	1	1	1	1	1	1
	Ethernet MAC	1	1	1	1	1	1	1	1	1
GPIO		80	80	80	80	112	112	112	112	112
EXMC		1	1	1	1	1	1	1	1	1
EXTI		16	16	16	16	16	16	16	16	16
ADC	Units	3	3	3	3	3	3	3	3	3
	Channels	16	16	16	16	21	21	21	21	21
DAC		2	2	2	2	2	2	2	2	2
Package		LQFP100				LQFP144				

2.2 Block diagram

Figure 1. GD32F107xx block diagram

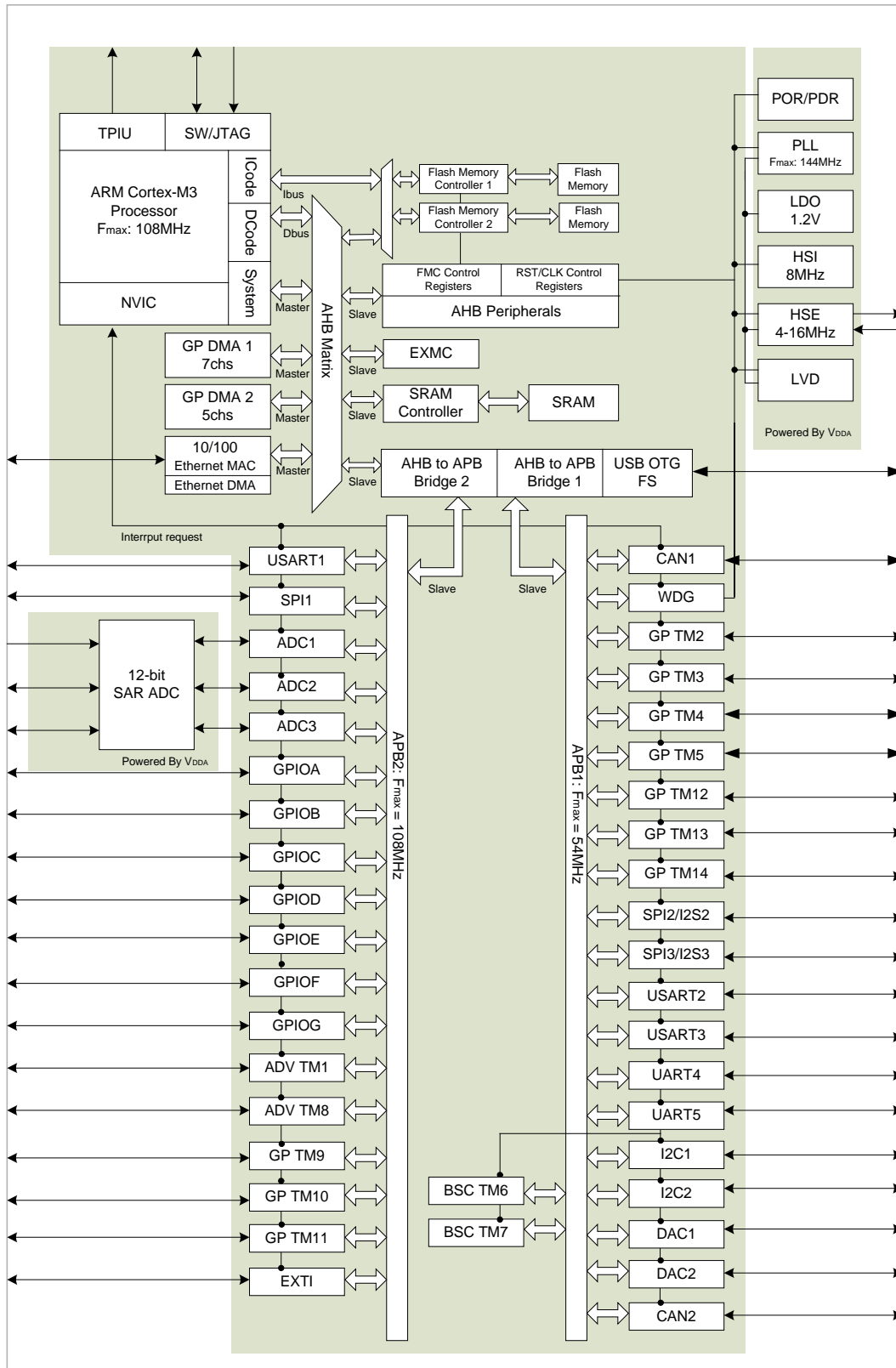

2.3 Pinouts and pin assignment

Figure 2. GD32F107Zx LQFP144 pinouts

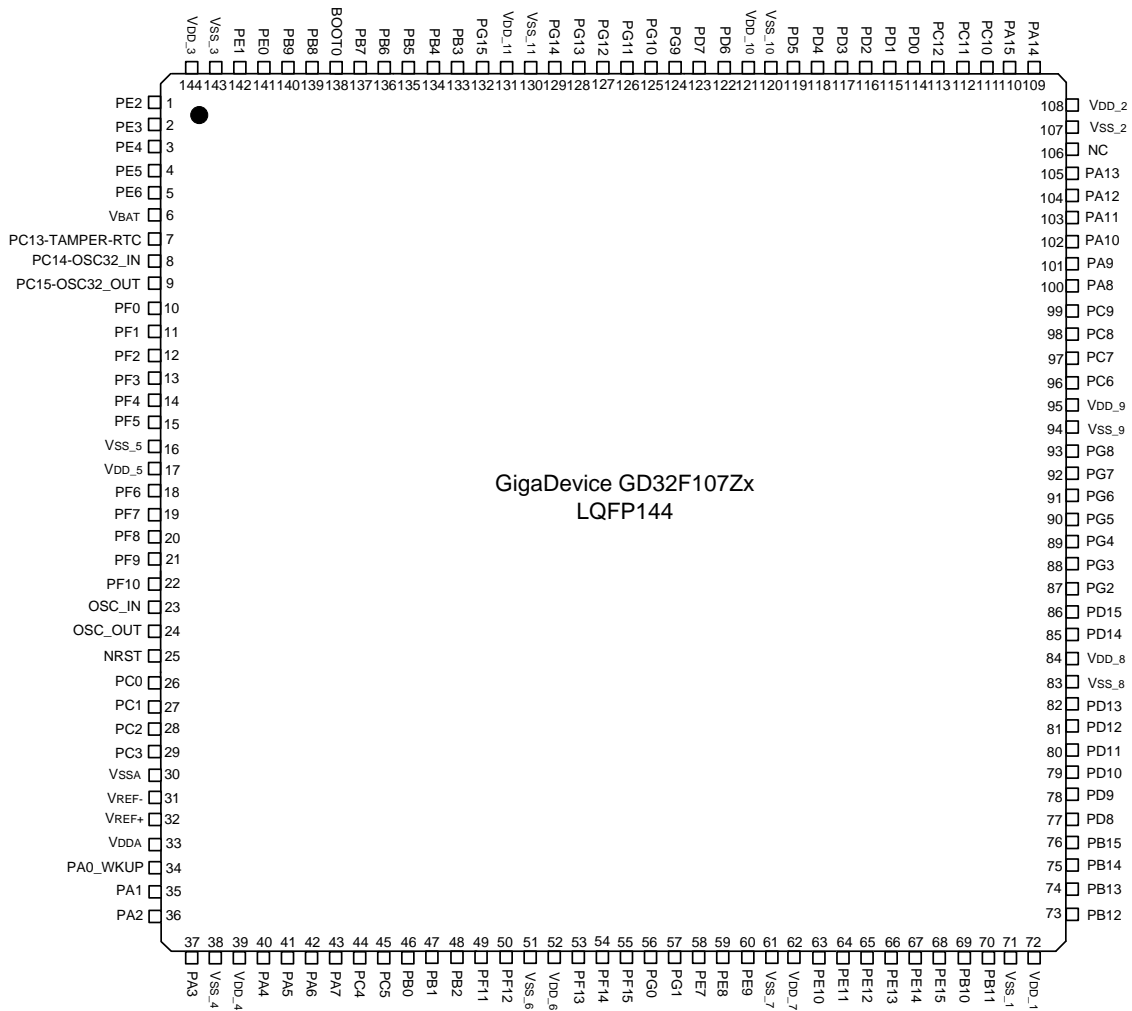

Figure 3. GD32F107Vx LQFP100 pinouts

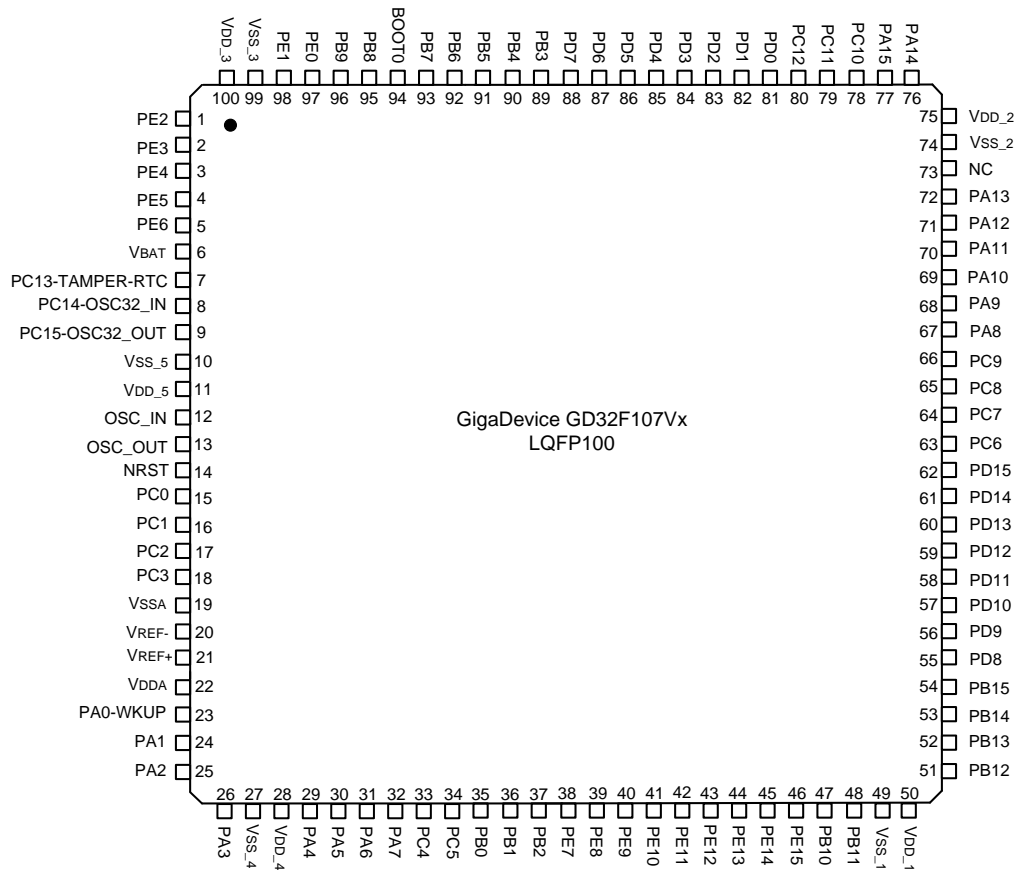
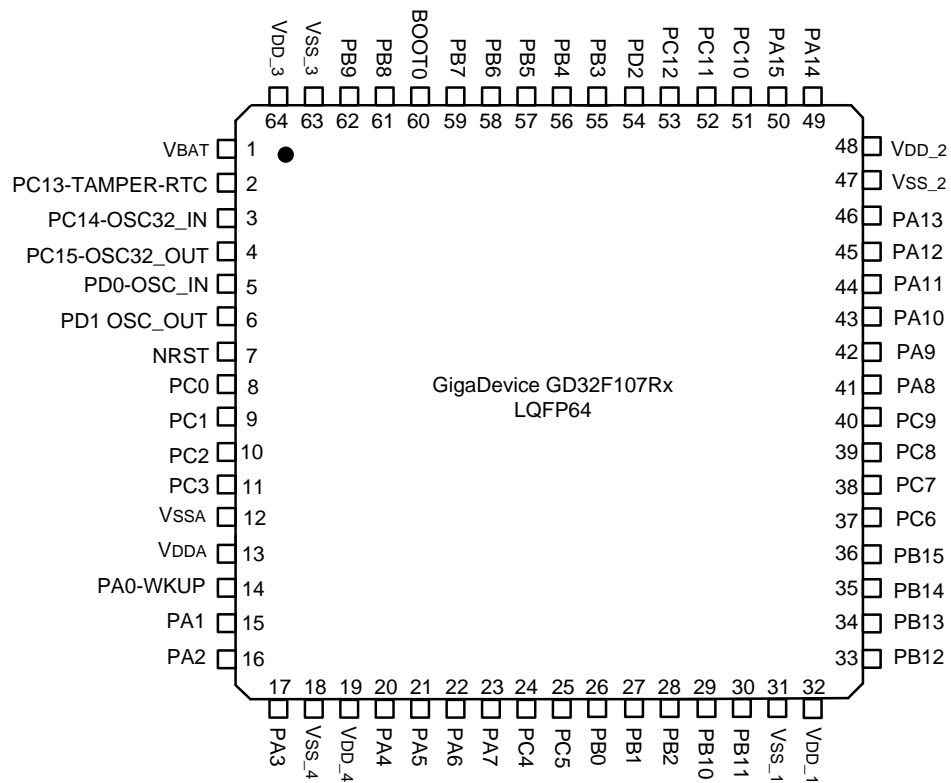
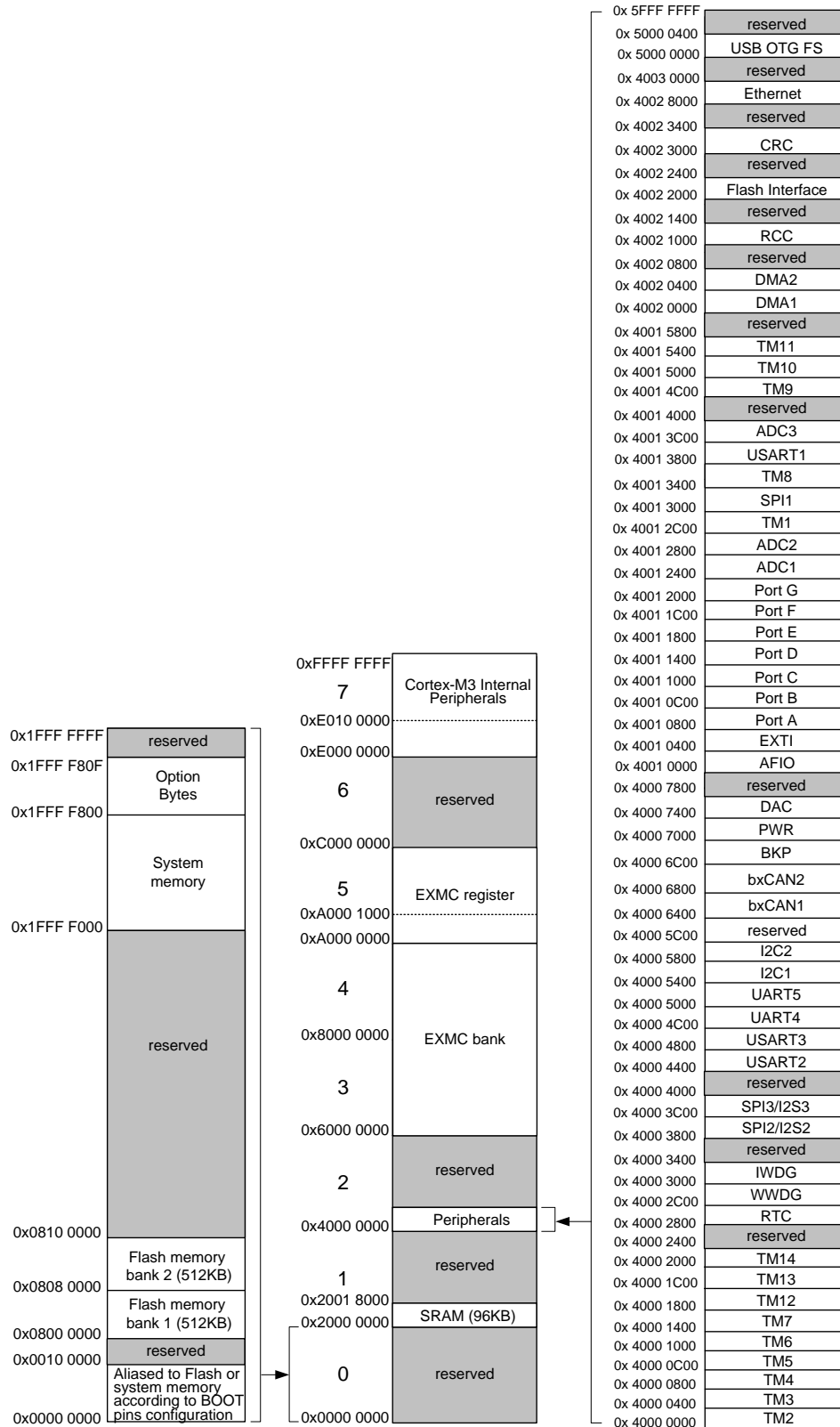

Figure 4. GD32F107Rx LQFP64 pinouts



2.4 Memory map

Figure 5. GD32F107xx memory map



2.5 Clock tree

Figure 6. GD32F107xx clock tree

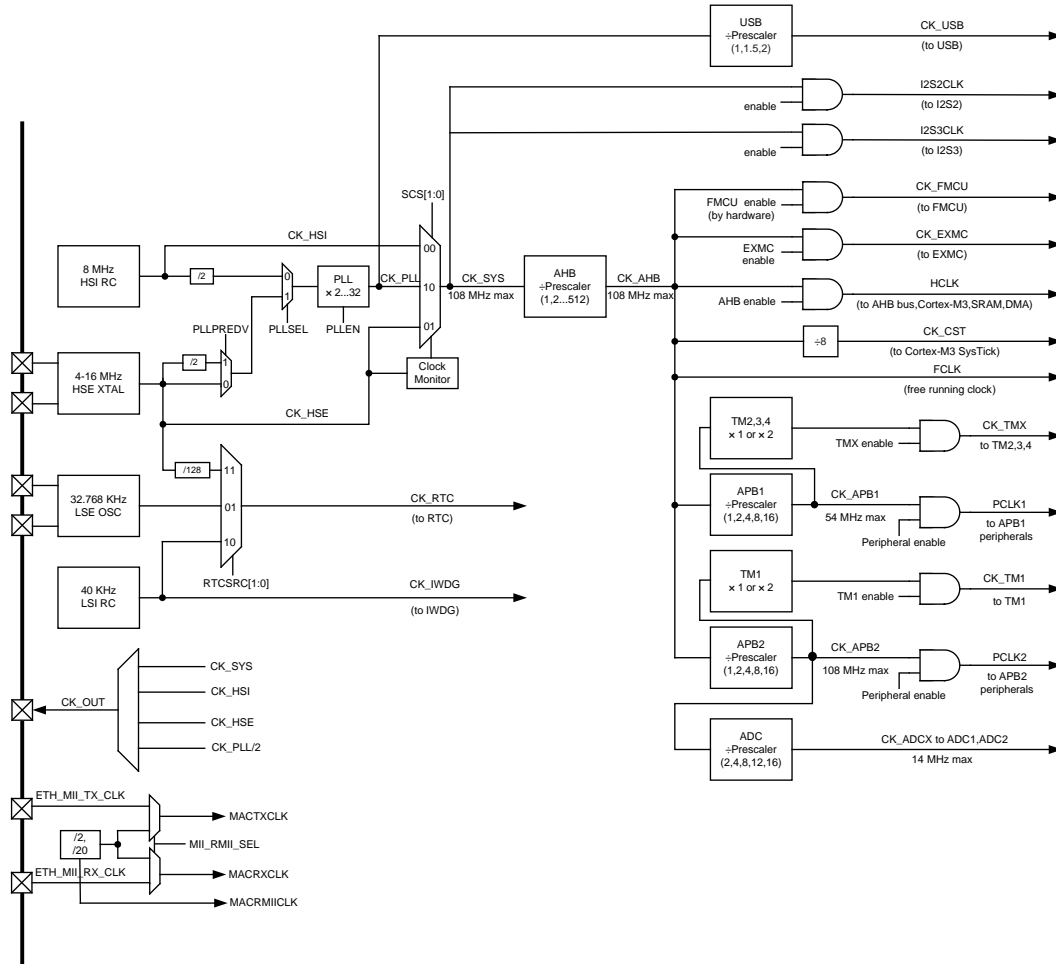

Legend:

- HSE = High speed external clock
- HSI = High speed internal clock
- LSE = Low speed external clock
- LSI = Low speed internal clock

2.6 Pin definitions

Table 2. GD32F107xx pin definitions

Pin Name	Pins			Pin Type ⁽¹⁾	I/O ⁽²⁾ Level	Functions description
	LQFP144	LQFP100	LQFP64			
PE2	1	1	-	I/O	5VT	Default: PE2 Alternate: TRACECK, EXMC_A23
PE3	2	2	-	I/O	5VT	Default: PE3 Alternate: TRACED0, EXMC_A19
PE4	3	3	-	I/O	5VT	Default: PE4 Alternate: TRACED1, EXMC_A20
PE5	4	4	-	I/O	5VT	Default: PE5 Alternate: TRACED2, EXMC_A21 Remap: TM9_CH1 ⁽⁴⁾
PE6	5	5	-	I/O	5VT	Default: PE6 Alternate: TRACED3, EXMC_A22 Remap: TM9_CH2 ⁽⁴⁾
V _{BAT}	6	6	1	P		Default: V _{BAT}
PC13-TAMPE R-RTC	7	7	2	I/O		Default: PC13 Alternate: TAMPER-RTC
PC14-OSC32 _IN	8	8	3	I/O		Default: PC14 Alternate: OSC32_IN
PC15- OSC32_OUT	9	9	4	I/O		Default: PC15 Alternate: OSC32_OUT
PF0	10	-	-	I/O	5VT	Default: PF0 ⁽³⁾ Alternate: EXMC_A0 ⁽³⁾
PF1	11	-	-	I/O	5VT	Default: PF1 ⁽³⁾ Alternate: EXMC_A1 ⁽³⁾
PF2	12	-	-	I/O	5VT	Default: PF2 ⁽³⁾ Alternate: EXMC_A2 ⁽³⁾
PF3	13	-	-	I/O	5VT	Default: PF3 ⁽³⁾ Alternate: EXMC_A3 ⁽³⁾
PF4	14	-	-	I/O	5VT	Default: PF4 ⁽³⁾ Alternate: EXMC_A4 ⁽³⁾
PF5	15	-	-	I/O	5VT	Default: PF5 ⁽³⁾ Alternate: EXMC_A5 ⁽³⁾
V _{SS_5}	16	10	-	P		Default: V _{SS_5}
V _{DD_5}	17	11	-	P		Default: V _{DD_5}
PF6	18	-	-	I/O		Default: PF6 ⁽³⁾ Alternate: ADC3_IN4 ⁽³⁾ , EXMC_NIORD ⁽³⁾ Remap: TM10_CH1 ⁽⁴⁾
PF7	19	-	-	I/O		Default: PF7 ⁽³⁾ Alternate: ADC3_IN5 ⁽³⁾ , EXMC_NREG ⁽³⁾

Pin Name	Pins			Pin Type ⁽¹⁾	I/O ⁽²⁾ Level	Functions description
	LQFP144	LQFP100	LQFP64			
						Remap: TM11_CH1 ⁽⁴⁾
PF8	20	-	-	I/O		Default: PF8 ⁽³⁾ Alternate: ADC3_IN6 ⁽³⁾ , EXMC_NIOWR ⁽³⁾ Remap: TM13_CH1 ⁽⁴⁾
PF9	21	-	-	I/O		Default: PF9 ⁽³⁾ Alternate: ADC3_IN7 ⁽³⁾ , EXMC_CD ⁽³⁾ Remap: TM14_CH1 ⁽⁴⁾
PF10	22	-	-	I/O		Default: PF10 ⁽³⁾ Alternate: ADC3_IN8 ⁽³⁾ , EXMC_INTR ⁽³⁾
OSC_IN	23	12	5	I		Default: OSC_IN Remap: PD0 ⁽⁴⁾
OSC_OUT	24	13	6	O		Default: OSC_OUT Remap: PD1 ⁽⁴⁾
NRST	25	14	7	I/O		Default: NRST
PC0	26	15	8	I/O		Default: PC0 Alternate: ADC_IN10
PC1	27	16	9	I/O		Default: PC1 Alternate: ADC_IN11, ETH_MII_MDC, ETH_RMII_MDC
PC2	28	17	10	I/O		Default: PC2 Alternate: ADC_IN12, ETH_MII_TXD2
PC3	29	18	11	I/O		Default: PC3 Alternate: ADC_IN13, ETH_MII_TX_CLK
V _{SSA}	30	19	12	P		Default: V _{SSA}
V _{REF-}	31	20	-	P		Default: V _{REF-}
V _{REF+}	32	21	-	P		Default: V _{REF+}
V _{DDA}	33	22	13	P		Default: V _{DDA}
PA0-WKUP	34	23	14	I/O		Default: PA0 Alternate: WKUP, USART2_CTS, ADC_IN0, TM2_CH1_ETR, TM5_CH1 ⁽³⁾ , TM8_ETR ⁽³⁾ , ETH_MII_CRS_WKUP
PA1	35	24	15	I/O		Default: PA1 Alternate: USART2_RTS, ADC_IN1, TM2_CH2, TM5_CH2 ⁽³⁾ , ETH_MII_RX_CLK, ETH_RMII_REF_CLK
PA2	36	25	16	I/O		Default: PA2 Alternate: USART2_TX, ADC_IN2, TM2_CH3, TM5_CH3 ⁽³⁾ , TM9_CH1 ⁽⁴⁾ , ETH_MII_MDIO, ETH_RMII_MDIO
PA3	37	26	17	I/O		Default: PA3 Alternate: USART2_RX, ADC_IN3, TM2_CH4, TM5_CH4 ⁽³⁾ , TM9_CH2 ⁽⁴⁾ , ETH_MII_COL
V _{SS_4}	38	27	18	P		Default: V _{SS_4}
V _{DD_4}	39	28	19	P		Default: V _{DD_4}
PA4	40	29	20	I/O		Default: PA4 Alternate: SPI1_NSS, USART2_CK, ADC12_IN4; DAC_OUT1 ⁽³⁾

Pin Name	Pins			Pin Type ⁽¹⁾	I/O ⁽²⁾ Level	Functions description
	LQFP144	LQFP100	LQFP64			
						Remap:SPI3_NSS ⁽³⁾ , I2S3_WS ⁽³⁾
PA5	41	30	21	I/O		Default: PA5 Alternate: SPI1_SCK, ADC12_IN5, DAC_OUT2 ⁽³⁾
PA6	42	31	22	I/O		Default: PA6 Alternate: SPI1_MISO, ADC12_IN6, TM3_CH1, TM8_BKIN ⁽³⁾ , TM13_CH1 ⁽⁴⁾ Remap: TM1_BKIN
PA7	43	32	23	I/O		Default: PA7 Alternate: SPI1_MOSI, ADC12_IN7, TM3_CH2, TM8_CH1N ⁽³⁾ , TM14_CH1 ⁽⁴⁾ , ETH_MII_RX_DV, ETH_RMII_CRD_DV Remap: TM1_CH1N
PC4	44	33	24	I/O		Default: PC4 Alternate: ADC12_IN14, ETH_MII_RXD0, ETH_RMII_RXD0
PC5	45	34	25	I/O		Default: PC5 Alternate: ADC12_IN15, ETH_MII_RXD1, ETH_RMII_RXD1
PB0	46	35	26	I/O		Default: PB0 Alternate: ADC12_IN8, TM3_CH3, TM8_CH2N ⁽³⁾ , ETH_MII_RXD2 Remap: TM1_CH2N
PB1	47	36	27	I/O		Default: PB1 Alternate: ADC12_IN9, TM3_CH4, TM8_CH3N ⁽³⁾ , ETH_MII_RXD3 Remap: TM1_CH3N
PB2	48	37	28	I/O	5VT	Default: PB2/BOOT1
PF11	49	-	-	I/O	5VT	Default: PF11 ⁽³⁾ Alternate: EXMC_NIOS16 ⁽³⁾
PF12	50	-	-	I/O	5VT	Default: PF12 ⁽³⁾ Alternate: EXMC_A6 ⁽³⁾
V _{SS_6}	51	-	-	P		Default: V _{SS_6}
V _{DD_6}	52	-	-	P		Default: V _{DD_6}
PF13	53	-	-	I/O	5VT	Default: PF13 ⁽³⁾ Alternate: EXMC_A7 ⁽³⁾
PF14	54	-	-	I/O	5VT	Default: PF14 ⁽³⁾ Alternate: EXMC_A8 ⁽³⁾
PF15	55	-	-	I/O	5VT	Default: PF15 ⁽³⁾ Alternate: EXMC_A9 ⁽³⁾
PG0	56	-	-	I/O	5VT	Default: PG0 ⁽³⁾ Alternate: EXMC_A10 ⁽³⁾
PG1	57	-	-	I/O	5VT	Default: PG1 ⁽³⁾ Alternate: EXMC_A11 ⁽³⁾
PE7	58	38	-	I/O	5VT	Default: PE7 Alternate: EXMC_D4 Remap: TM1_ETR
PE8	59	39	-	I/O	5VT	Default: PE8 Alternate: EXMC_D5

Pin Name	Pins			Pin Type ⁽¹⁾	I/O ⁽²⁾ Level	Functions description
	LQFP144	LQFP100	LQFP64			
						Remap: TM1_CH1N
PE9	60	40	-	I/O	5VT	Default: PE9 Alternate: EXMC_D6 Remap: TM1_CH1
V _{SS_7}	61	-	-	P		Default: V _{SS_7}
V _{DD_7}	62	-	-	P		Default: V _{DD_7}
PE10	63	41	-	I/O	5VT	Default: PE10 Alternate: EXMC_D7 Remap: TM1_CH2N
PE11	64	42	-	I/O	5VT	Default: PE11 Alternate: EXMC_D8 Remap: TM1_CH2
PE12	65	43	-	I/O	5VT	Default: PE12 Alternate: EXMC_D9 Remap: TM1_CH3N
PE13	66	44	-	I/O	5VT	Default: PE13 Alternate: EXMC_D10 Remap: TM1_CH3
PE14	67	45	-	I/O	5VT	Default: PE14 Alternate: EXMC_D11 Remap: TM1_CH4
PE15	68	46	-	I/O	5VT	Default: PE15 Alternate: EXMC_D12 Remap: TM1_BKIN
PB10	69	47	29	I/O	5VT	Default: PB10 Alternate: I2C2_SCL, USART3_TX, ETH_MII_RX_ER Remap: TM2_CH3
PB11	70	48	30	I/O	5VT	Default: PB11 Alternate: I2C2_SDA, USART3_RX, ETH_MII_TX_EN, ETH_RMII_TX_EN Remap: TM2_CH4
V _{SS_1}	71	49	31	P		Default: V _{SS_1}
V _{DD_1}	72	50	32	P		Default: V _{DD_1}
PB12	73	51	33	I/O	5VT	Default: PB12 Alternate: SPI2_NSS, I2C2_SMBAL, USART3_CK, TM1_BKIN, I2S2_WS ⁽³⁾ , CAN2_RX, ETH_MII_TXD0, ETH_RMII_TXD0
PB13	74	52	34	I/O	5VT	Default: PB13 Alternate: SPI2_SCK, USART3_CTS, TM1_CH1N, I2S2_CK ⁽³⁾ , CAN2_TX, ETH_MII_TXD1, ETH_RMII_TXD1
PB14	75	53	35	I/O	5VT	Default: PB14 Alternate: SPI2_MISO, USART3_RTS, TM1_CH2N, TM12_CH1 ⁽⁴⁾
PB15	76	54	36	I/O	5VT	Default: PB15 Alternate: SPI2_MOSI, TM1_CH3N, I2S2_SD ⁽³⁾ , TM12_CH2 ⁽⁴⁾
PD8	77	55	-	I/O	5VT	Default: PD8

Pin Name	Pins			Pin Type ⁽¹⁾	I/O ⁽²⁾ Level	Functions description
	LQFP144	LQFP100	LQFP64			
						Alternate: EXMC_D13 Remap: USART3_TX, ETH_MII_RX_DV, ETH_RMII_CRD_DV
PD9	78	56	-	I/O	5VT	Default: PD9 Alternate: EXMC_D14 Remap: USART3_RX, ETH_MII_RXD0, ETH_RMII_RXD0
PD10	79	57	-	I/O	5VT	Default: PD10 Alternate: EXMC_D15 Remap: USART3_CK, ETH_MII_RXD1, ETH_RMII_RXD1
PD11	80	58	-	I/O	5VT	Default: PD11 Alternate: EXMC_A16 Remap: USART3_CTS, ETH_MII_RXD2
PD12	81	59	-	I/O	5VT	Default: PD12 Alternate: EXMC_A17 Remap: TM4_CH1, USART3_RTS
PD13	82	60	-	I/O	5VT	Default: PD13 Alternate: EXMC_A18 Remap: TM4_CH2, USART3_RTS, ETH_MII_RXD3
V _{SS_8}	83	-	-	P		Default: V _{SS_8}
V _{DD_8}	84	-	-	P		Default: V _{DD_8}
PD14	85	61	-	I/O	5VT	Default: PD14 Alternate: EXMC_D0 Remap: TM4_CH3
PD15	86	62	-	I/O	5VT	Default: PD15 Alternate: EXMC_D1 Remap: TM4_CH4
PG2	87	-	-	I/O	5VT	Default: PG2 ⁽³⁾ Alternate: EXMC_A12 ⁽³⁾
PG3	88	-	-	I/O	5VT	Default: PG3 ⁽³⁾ Alternate: EXMC_A13 ⁽³⁾
PG4	89	-	-	I/O	5VT	Default: PG4 ⁽³⁾ Alternate: EXMC_A14 ⁽³⁾
PG5	90	-	-	I/O	5VT	Default: PG5 ⁽³⁾ Alternate: EXMC_A15 ⁽³⁾
PG6	91	-	-	I/O	5VT	Default: PG6 ⁽³⁾ Alternate: EXMC_INT2 ⁽³⁾
PG7	92	-	-	I/O	5VT	Default: PG7 ⁽³⁾ Alternate: EXMC_INT3 ⁽³⁾
PG8	93	-	-	I/O	5VT	Default: PG8 ⁽³⁾
V _{SS_9}	94	-	-	P		Default: V _{SS_9}
V _{DD_9}	95	-	-	P		Default: V _{DD_9}
PC6	96	63	37	I/O	5VT	Default: PC6 Alternate: I2S2_MCK ⁽³⁾ ; TM8_CH1 ⁽³⁾ Remap: TM3_CH1

Pin Name	Pins			Pin Type ⁽¹⁾	I/O ⁽²⁾ Level	Functions description
	LQFP144	LQFP100	LQFP64			
PC7	97	64	38	I/O	5VT	Default: PC7 Alternate: I2S3_MCK ⁽³⁾ ; TM8_CH2 ⁽³⁾ Remap: TM3_CH2
PC8	98	65	39	I/O	5VT	Default: PC8 Alternate: TM8_CH3 ⁽³⁾ Remap: TM3_CH3
PC9	99	66	40	I/O	5VT	Default: PC9 Alternate: TM8_CH4 ⁽³⁾ Remap: TM3_CH4
PA8	100	67	41	I/O	5VT	Default: PA8 Alternate: USART1_CK, TM1_CH1, MCO
PA9	101	68	42	I/O	5VT	Default: PA9 Alternate: USART1_TX, TM1_CH2, OTG_FS_VBUS
PA10	102	69	43	I/O	5VT	Default: PA10 Alternate: USART1_RX, TM1_CH3, OTG_FS_ID
PA11	103	70	44	I/O	5VT	Default: PA11 Alternate: USART1_CTS, CANRX, OTG_FS_DM, TM1_CH4
PA12	104	71	45	I/O	5VT	Default: PA12 Alternate: USART1_RTS, OTG_FS_DP, CAN1_TX, TM1_ETR
PA13	105	72	46	I/O	5VT	Default: JTMS, SWDIO Remap: PA13
NC	106	73	-			-
V _{SS_2}	107	74	47	P		Default: V _{SS_2}
V _{DD_2}	108	75	48	P		Default: V _{DD_2}
PA14	109	76	49	I/O	5VT	Default: JTCK, SWCLK Remap: PA14
PA15	110	77	50	I/O	5VT	Default: JTDI Alternate: SPI3_NSS ⁽³⁾ , I2S3_WS ⁽³⁾ Remap: TM2_CH1_ETR, PA15, SPI1_NSS
PC10	111	78	51	I/O	5VT	Default: PC10 Alternate: UART4_TX ⁽³⁾ Remap: USART3_TX, SPI3_SCK ⁽³⁾ , I2S3_CK ⁽³⁾
PC11	112	79	52	I/O	5VT	Default: PC11 Alternate: UART4_RX ⁽³⁾ Remap: USART3_RX, SPI3_MISO ⁽³⁾
PC12	113	80	53	I/O	5VT	Default: PC12 Alternate: UART5_TX ⁽³⁾ Remap: USART3_CK, SPI3_MOSI ⁽³⁾ , I2S3_SD ⁽³⁾
PD0	114	81	5	I/O	5VT	Default: PD0 Alternate: EXMC_D2 Remap: CAN1_RX, OSC_IN
PD1	115	82	6	I/O	5VT	Default: PD1 Alternate: EXMC_D3

Pin Name	Pins			Pin Type ⁽¹⁾	I/O ⁽²⁾ Level	Functions description
	LQFP144	LQFP100	LQFP64			
						Remap: CAN1_TX, OSC_OUT
PD2	116	83	54	I/O	5VT	Default: PD2 Alternate: TM3_ETR, UART5_RX ⁽³⁾
PD3	117	84	-	I/O	5VT	Default: PD3 Alternate: EXMC_CLK Remap: USART2_CTS
PD4	118	85	-	I/O	5VT	Default: PD4 Alternate: EXMC_NOE Remap: USART2_RTS
PD5	119	86	-	I/O	5VT	Default: PD5 Alternate: EXMC_NWE Remap: USART2_TX
V _{SS_10}	120	-	-			Default: V _{SS_10}
V _{DD_10}	121	-	-			Default: V _{DD_10}
PD6	122	87	-	I/O	5VT	Default: PD6 Alternate: EXMC_NWAIT Remap: USART2_RX
PD7	123	88	-	I/O	5VT	Default: PD7 Alternate: EXMC_NE1/EXMC_NCE2 Remap: USART2_CK
PG9	124	-	-	I/O	5VT	Default: PG9 ⁽³⁾ Alternate: EXMC_NE2 ⁽³⁾ , EXMC_NCE3 ⁽³⁾
PG10	125	-	-	I/O	5VT	Default: PG10 ⁽³⁾ Alternate: EXMC_NCE4_1 ⁽³⁾ , EXMC_NE3 ⁽³⁾
PG11	126	-	-	I/O	5VT	Default: PG11 ⁽³⁾ Alternate: EXMC_NCE4_2 ⁽³⁾
PG12	127	-	-	I/O	5VT	Default: PG12 ⁽³⁾ Alternate: EXMC_NE4 ⁽³⁾
PG13	128	-	-	I/O	5VT	Default: PG13 ⁽³⁾ Alternate: EXMC_A24 ⁽³⁾
PG14	129	-	-	I/O	5VT	Default: PG14 ⁽³⁾ Alternate: EXMC_A25 ⁽³⁾
V _{SS_11}	130	-	-	P		Default: V _{SS_10}
V _{DD_11}	131	-	-	P		Default: V _{DD_10}
PG15	132	-	-	I/O	5VT	Default: PG15
PB3	133	89	55	I/O	5VT	Default: JTDO Alternate: SPI3_SCK ⁽³⁾ , I2S3_CK ⁽³⁾ Remap: PB3, TRACESWO, TM2_CH2, SPI1_SCK
PB4	134	90	56	I/O	5VT	Default: NJTRST Alternate: SPI3_MISO ⁽³⁾ Remap: TM3_CH1, PB4, SPI1_MISO
PB5	135	91	57	I/O		Default: PB5 Alternate: I2C1_SMBAL, SPI3_MOSI ⁽³⁾ , I2S3_SD ⁽³⁾ , ETH_MII_PPS,

Pin Name	Pins			Pin Type ⁽¹⁾	I/O ⁽²⁾ Level	Functions description
	LQFP144	LQFP100	LQFP64			
						ETH_RMII_PPS_OUT Remap: TM3_CH2, SPI1_MOSI, CAN2_RX
PB6	136	92	58	I/O	5VT	Default: PB6 Alternate: I2C1_SCL, TM4_CH1, Remap: USART1_TX, CAN2_TX
PB7	137	93	59	I/O	5VT	Default: PB7 Alternate: I2C1_SDA, TM4_CH2, EXMC_NADV ⁽³⁾ Remap: USART1_RX
BOOT0	138	94	60	I		Default: BOOT0
PB8	139	95	61	I/O	5VT	Default: PB8 Alternate: TM4_CH3, TM10_CH1 ⁽⁴⁾ , ETH_MII_TXD3 Remap: I2C1_SCL, CAN1_RX
PB9	140	96	62	I/O	5VT	Default: PB9 Alternate: TM4_CH4, TM11_CH1 ⁽⁴⁾ Remap: I2C1_SDA, CAN1_TX
PE0	141	97	-	I/O	5VT	Default: PE0 Alternate: TM4_ETR, EXMC_NBL0
PE1	142	98	-	I/O	5VT	Default: PE1 Alternate: EXMC_NBL1
V _{SS_3}	143	99	63	P		Default: V _{SS_3}
V _{DD_3}	144	100	64	P		Default: V _{DD_3}

Notes:

1. Type: I = input, O = output, P = power.
2. I/O Level: 5VT = 5 V tolerant.
3. Functions are available in GD32F107xC, GD32F107xD, GD32F107xE, GD32F107xF, GD32F107xG devices.
4. Functions are available in GD32F107xF, GD32F107xG devices.

3 Functional description

3.1 ARM[®] Cortex[™]-M3 core

The Cortex[™]-M3 processor is the latest generation of ARM[®] processors for embedded systems. It has been developed to provide a low-cost platform that meets the needs of MCU implementation, with a reduced pin count and low-power consumption, while delivering outstanding computational performance and an advanced system response to interrupts.

- 32-bit ARM[®] Cortex[™]-M3 processor core
- Up to 108 MHz operation frequency
- Single-cycle multiplication and hardware divider
- Integrated Nested Vectored Interrupt Controller (NVIC)
- 24-bit SysTick timer

The Cortex[™]-M3 processor is based on the ARMv7 architecture and supports both Thumb and Thumb-2 instruction sets. Some system peripherals listed below are also provided by Cortex[™]-M3:

- Internal Bus Matrix connected with ICode bus, DCode bus, system bus, Private Peripheral Bus (PPB) and debug accesses (AHB-AP)
- Nested Vectored Interrupt Controller (NVIC)
- Flash Patch and Breakpoint (FPB)
- Data Watchpoint and Trace (DWT)
- Instrument Trace Macrocell (ITM)
- Memory Protection Unit (MPU)
- Serial Wire JTAG Debug Port (SWJ-DP)
- Trace Port Interface Unit (TPIU)

3.2 On-chip memory

- Up to 1024 Kbytes of Flash memory
- 96 Kbytes of SRAM

The ARM[®] Cortex[™]-M3 processor is structured in Harvard architecture which can use separate buses to fetch instructions and load/store data. 1024 Kbytes of inner Flash at most and 96 Kbytes of inner SRAM is available for storing programs and data, both accessed (R/W) at CPU clock speed with zero wait states. The Figure 6. GD32F107xx memory map shows the memory map of the GD32F107xx series of devices, including code, SRAM, peripheral, and other pre-defined regions.

3.3 Clock, reset and supply management

- Internal 8 MHz factory-trimmed RC and external 4 to 16 MHz crystal oscillator
- Internal 40 KHz RC calibrated oscillator and external 32.768 KHz crystal oscillator
- Integrated system clock PLL
- 2.6 to 3.6 V application supply and I/Os
- Supply Supervisor: POR (Power On Reset), PDR (Power Down Reset), and low voltage detector (LVD)

The Clock Control Unit (CCU) provides a range of oscillator and clock functions. These include speed internal RC oscillator and external crystal oscillator, high speed and low speed two types. Several prescalers allow the configuration of the AHB frequency, the high-speed APB (APB2) and the low-speed APB (APB1) domains. The maximum frequency of the AHB and the high-speed APB domains is 108 MHz. The maximum allowed frequency of the low-speed APB domain is 54 MHz. See Figure 7 for details on the clock tree.

The Reset Control Unit (RCU) controls three kinds of reset: system reset resets the processor core and peripheral IP components. Power-on reset (POR) and power-down reset (PDR) are always active, and ensures proper operation starting from/down to 2.6 V. The device remains in reset mode when V_{DD} is below a specified threshold. The embedded low voltage detector (LVD) monitors the power supply, compares it to the voltage threshold and generates an interrupt as a warning message for leading the MCU into security.

Power supply schemes:

- V_{DD} range: 2.6 to 3.6 V, external power supply for I/Os and the internal regulator. Provided externally through V_{DD} pins.
- V_{SSA} , V_{DDA} range: 2.6 to 3.6 V, external analog power supplies for ADC, reset blocks, RCs and PLL. V_{DDA} and V_{SSA} must be connected to V_{DD} and V_{SS} , respectively.
- V_{BAT} range: 1.8 to 3.6 V, power supply for RTC, external clock 32 kHz oscillator and backup registers (through power switch) when V_{DD} is not present.

3.4 Boot modes

At startup, boot pins are used to select one of three boot options:

- Boot from main flash memory (default)
- Boot from system memory
- Boot from on-chip SRAM

The boot loader is located in the internal boot ROM memory (system memory). It is used to reprogram the Flash memory by using USART1, USART2, CAN2, USB OTG FS in device mode. It also can be used to transfer and update the Flash memory code, the data and the vector table sections. In default condition, boot from bank 1 of Flash memory is selected. It also supports to boot from bank 2 of Flash memory by setting a bit in option bytes.

3.5 Power saving modes

The MCU supports three kinds of power saving modes to achieve even lower power consumption. They are Sleep mode, Deep-sleep mode, and Standby mode. These operating modes reduce the power consumption and allow the application to achieve the best balance between the CPU operating time, speed and power consumption.

■ Sleep mode

In sleep mode, only the clock of CPU core is off. All peripherals continue to operate and any interrupt/event can wake up the system.

■ Deep-sleep mode

In Deep-sleep mode, all clocks in the 1.2V domain are off, and all of the high speed crystal oscillator (HSI, HSE) and PLL are disabled. Only the contents of SRAM and registers are retained. Any interrupt or wakeup event from EXTI lines can wake up the system from the Deep-sleep mode including the 16 external lines, the RTC alarm, the LVD output, and USB wakeup. When exiting the Deep-sleep mode, the HSI is selected as the system clock.

■ Standby mode

In Standby mode, the whole 1.2V domain is power off, the LDO is shut down, and all of HSI, HSE and PLL are disabled. The contents of SRAM and registers (except Backup Registers) are lost. There are four wakeup sources for the Standby mode, including the external reset from NRST pin, the RTC alarm, the IWDG reset, and the rising edge on WKUP pin.

3.6 Analog to digital converter (ADC)

- 12-bit SAR ADC engine
- Up to 1 MSPS conversion rate
- Conversion range: V_{SSA} to V_{DDA} (2.6 to 3.6 V)
- Temperature sensor

Up to three 12-bit 1 μ s multi-channel ADCs are integrated in the device. Each is a total of up to 21 multiplexed external channels. An analog watchdog block can be used to detect the channels, which are required to remain within a specific threshold window. A configurable channel management block of analog inputs also can be used to perform conversions in single, continuous, scan or discontinuous mode to support more advanced usages.

The ADCs can be triggered from the events generated by the general-purpose timers (TMx) and the advanced-control timers (TM1 and TM8) with internal connection. The temperature sensor has to generate a voltage that varies linearly with temperature. The conversion range is between $2.6\text{ V} < V_{DDA} < 3.6\text{ V}$. The temperature sensor is internally connected to the ADC_IN16 input channel which is used to convert the sensor output voltage into a digital value.

3.7 Digital to analog converter (DAC)

- Two 12-bit DAC converters of independent output channel
- 8-bit or 12-bit mode in conjunction with the DMA controller

The two 12-bit buffered DAC channels are used to generate variable analog outputs. The DACs are designed with integrated resistor strings structure. The DAC channels can be triggered by the timer update outputs or EXTI with DMA support. In dual DAC channel operation, conversions could be done independently or simultaneously. The maximum output value of the DAC is V_{REF+} .

3.8 DMA

- 7 channel DMA 1 controller and 5 channel DMA 2 controller
- Peripherals supported: Timers, ADC, SPIs, I²Cs, USARTs, DAC, I²S
- Dedicated DMA controller with the Ethernet application

The flexible general-purpose DMA controllers provide a hardware method of transferring data between peripherals and/or memory without intervention from the CPU, thereby freeing up bandwidth for other system functions. Four types of access method are supported: peripheral to peripheral, peripheral to memory, memory to peripheral, memory to memory

Each channel is connected to fixed hardware DMA requests. The priorities of DMA channel requests are determined by software configuration and hardware channel number. Transfer size of source and destination are independent and configurable.

3.9 General-purpose inputs/outputs (GPIOs)

- Up to 112 fast GPIOs, all mappable on 16 external interrupt vectors (EXTI)
- Analog input/output configurable
- Alternate function input/output configurable

There are up to 112 general purpose I/O pins (GPIO) in GD32F107xx, named PA0 ~ PA15 and PB0 ~ PB15, PC0 ~ PC15, PD0 ~ PD15, PE0 ~ PE15, PF0-PF15, PG0-PG15 to implement logic input/output functions. Each of the GPIO ports has related control and configuration registers to satisfy the requirements of specific applications. The external interrupts on the GPIO pins of the device have related control and configuration registers in the External Interrupt Control Unit (EXTI). The GPIO ports are pin-shared with other alternative functions (AFs) to obtain maximum flexibility on the package pins. Each of the GPIO pins can be configured by software as output (push-pull or open-drain), as input (with or without pull-up or pull-down) or as peripheral alternate function. Most of the GPIO pins are shared with digital or analog alternate functions. All GPIOs are high-current capable except for analog inputs.

3.10 Timers and PWM generation

- Up to two 16-bit advanced-control timer (TM1 & TM8), ten 16-bit general-purpose timers (GPTM), and two 16-bit basic timer (TM6 & TM7)
- Up to 4 independent channels of PWM, output compare or input capture for each GPTM and external trigger input
- 16-bit, motor control PWM advanced-control timer with programmable dead-time generation for output match
- Encoder interface controller with two inputs using quadrature decoder
- 24-bit SysTick timer down counter
- 2 watchdog timers (Independent watchdog and window watchdog)

The advanced-control timer (TM1 & TM8) can be seen as a three-phase PWM multiplexed on 6 channels. It has complementary PWM outputs with programmable dead-time generation. It can also be used as a complete general-purpose timer. The 4 independent channels can be used for

- Input capture
- Output compare
- PWM generation (edge- or center-aligned counting modes)
- Single pulse mode output

If configured as a general-purpose 16-bit timer, it has the same functions as the TMx timer. It can be synchronized with external signals or to interconnect with other GPTMs together which have the same architecture and features.

The general-purpose timer (GPTM), known as TM2 ~ TM5, TM9 ~ TM11, TM12 ~ TM14 can be used for a variety of purposes including general time, input signal pulse width measurement or output waveform generation such as a single pulse generation or PWM output, up to 4 independent channels for input capture/output compare. The GPTM also supports an encoder interface with two inputs using quadrature decoder.

The basic timer, known as TM6 and TM7 are mainly used for DAC trigger generation. They can also be used as a simple 16-bit time base.

The GD32F107xx have two watchdog peripherals, Independent watchdog and window watchdog. They offer a combination of high safety level, flexibility of use and timing accuracy.

The independent watchdog timer includes a 12-bit down-counting counter and a 8-bit prescaler, It is clocked from an independent 40 kHz internal RC and as it operates independently of the main clock, it can operate in stop and standby modes. It can be used either as a watchdog to reset the device when a problem occurs, or as a free-running timer for application timeout management.

The window watchdog is based on a 7-bit down counter that can be set as free-running. It can be used as a watchdog to reset the device when a problem occurs. It is clocked from the main clock. It has an early warning interrupt capability and the counter can be frozen in

debug mode.

The SysTick timer is dedicated for OS, but could also be used as a standard down counter. It features:

- A 24-bit down counter
- Auto reload capability
- Maskable system interrupt generation when the counter reaches 0
- Programmable clock source

3.11 Real time clock (RTC)

- 32-bit up-counter with a programmable 20-bit prescaler
- Alarm function
- Interrupt and wake-up event

The real time clock is an independent timer which provides a set of continuously running counters which can be used with suitable software to provide a clock calendar function, and provides an alarm interrupt and an expected interrupt. The RTC features a 32-bit programmable counter for long-term measurement using the compare register to generate an alarm. A 20-bit prescaler is used for the time base clock and is by default configured to generate a time base of 1 second from a clock at 32.768 kHz from external crystal oscillator.

3.12 Inter-integrated circuit (I2C)

- Up to two I2C bus interfaces can support both master and slave mode with a frequency up to 400 kHz
- Provide arbitration function, optional PEC (packet error checking) generation and checking
- Supports 7-bit and 10-bit addressing mode and general call addressing mode

The I2C interface is an internal circuit allowing communication with an external I2C interface which is an industry standard two line serial interface used for connection to external hardware. These two serial lines are known as a serial data line (SDA) and a serial clock line (SCL). The I2C module provides two data transfer rates: 100 kHz of standard mode or 400 kHz of the fast mode. The I2C module also has an arbitration detect function to prevent the situation where more than one master attempts to transmit data to the I2C bus at the same time. A CRC-8 calculator is also provided in I2C interface to perform packet error checking for I2C data.

3.13 Serial peripheral interface (SPI)

- Up to two SPI interfaces with a frequency of up to 18 MHz
- Support both master and slave mode
- Hardware CRC calculation and transmit automatic CRC error checking

The SPI interface uses 4 pins, among which are the serial data input and output lines (MISO & MOSI), the clock line (SCK) and the slave select line (NSS). Both SPIs can be served by the DMA controller. The SPI interface may be used for a variety of purposes, including simplex synchronous transfers on two lines with a possible bidirectional data line or reliable communication using CRC checking.

3.14 Universal synchronous asynchronous receiver transmitter (USART)

- Up to three USARTs with operating frequency up to 4.5 MHz
- Supports both asynchronous and clocked synchronous serial communication modes
- IrDA SIR encoder and decoder support
- LIN break generation and detection
- USARTs support ISO 7816-3 compliant smart card interface

The USART (USART1, USART2 and USART3) are used to translate data between parallel and serial interfaces, provides a flexible full duplex data exchange using synchronous or asynchronous transfer. It is also commonly used for RS-232 standard communication. The USART includes a programmable baud rate generator which is capable of dividing the system clock to produce a dedicated clock for the USART transmitter and receiver. The USART also supports DMA function for high speed data communication except UART5.

3.15 Inter-IC sound (I2S)

- Two I2S bus Interfaces with sampling frequency from 8 kHz to 192 kHz
- Support either master or slave mode

The Inter-IC sound (I2S) bus provides a standard communication interface for digital audio applications by 3-wire serial lines. GD32F107xx contain two I2S-bus interfaces that can be operated with 16/32 bit resolution in master or slave mode, pin multiplexed with SPI2 and SPI3. The audio sampling frequency from 8 kHz to 192 kHz is supported with less than 0.5% accuracy error.

3.16 Universal serial bus on-the-go full-speed (USB OTG FS)

- One USB device/host/OTG full-speed Interface with frequency up to 12 Mbit/s
- Internal main PLL for USB CLK compliantly

The Universal Serial Bus (USB) is a 4-wire bus with 4 bidirectional endpoints. The device controller enables 12 Mbit/s data exchange with integrated transceivers in device/host/OTG mode. Full-speed peripheral is compliant with the USB 2.0 specification. Transaction formatting is performed by the hardware, including CRC generation and checking. The status of a completed USB transfer or error condition is indicated by status registers. An interrupt is also generated if enabled. The dedicated 48 MHz clock is generated from the internal main PLL (the clock source must use a HSE crystal oscillator) and the operating frequency divided from APB1 should be 12 MHz above.

3.17 Controller area network (CAN)

- Two CAN2.0B interface with communication frequency up to 1 Mbit/s
- Internal main PLL for USB CLK compliantly

Controller area network (CAN) is a method for enabling serial communication in field bus. The CAN protocol has been used extensively in industrial automation and automotive applications. It can receive and transmit standard frames with 11-bit identifiers as well as extended frames with 29-bit identifiers. Each CAN has three mailboxes for transmission and two FIFOs of three message deep for reception. It also provides 14 scalable/configurable identifier filter banks for selecting the incoming messages needed and discarding the others.

3.18 Ethernet MAC interface

- IEEE 802.3 compliant media access controller (MAC) for Ethernet LAN
- 10/100 Mbit/s rates with dedicated DMA controller and SRAM
- Support hardware precision time protocol (PTP) with conformity to IEEE 1588

The Ethernet media access controller (MAC) conforms to IEEE 802.3 specifications and fully supports IEEE 1588 standards. The embedded MAC provides the interface to the required external network physical interface (PHY) for LAN bus connection via an internal media independent interface (MII) or a reduced media independent interface (RMII). The number of MII signals provided up to 17 with 25 MHz output and RMII up to 9 with 50 MHz output. The function of 32-bit CRC checking is also available.

3.19 External memory controller (EXMC)

- Supported external memory: SRAM, PSRAM, ROM and NOR-Flash, NAND Flash and CF card
- Up to 16-bit data bus
- Support to interface with Motorola 6800 and Intel 8080 type LCD directly

External memory controller (EXMC) is an abbreviation of external memory controller. It is divided in to several sub-banks for external device support, each sub-bank has its own chip selection signal but at one time, only one bank can be accessed. The EXMC support code execution from external memory except NAND Flash and CF card. The EXMC also can be configured to interface with the most common LCD module of Motorola 6800 and Intel 8080 series and reduce the system cost and complexity.

3.20 Debug mode

- Serial wire JTAG debug port (SWJ-DP)

The ARM[®] SWJ-DP Interface is embedded and is a combined JTAG and serial wire debug port that enables either a serial wire debug or a JTAG probe to be connected to the target.

3.21 Package and operation temperature

- LQFP144 (GD32F107Zx), LQFP100 (GD32F107Vx), LQFP64 (GD32F107Rx)
- Operation temperature range: -40°C to +85°C (industrial level)

4 Electrical characteristics

4.1 Absolute maximum ratings

The maximum ratings are the limits to which the device can be subjected without permanently damaging the device. Note that the device is not guaranteed to operate properly at the maximum ratings. Exposure to the absolute maximum rating conditions for extended periods may affect device reliability.

Table 3. Absolute maximum ratings

Symbol	Parameter	Min	Max	Unit
V_{DD}	External voltage range	$V_{SS} - 0.3$	$V_{SS} + 3.6$	V
V_{DDA}	External analog supply voltage	$V_{SSA} - 0.3$	$V_{SSA} + 3.6$	V
V_{BAT}	External battery supply voltage	$V_{SS} - 0.3$	$V_{SS} + 3.6$	V
V_{IN}	Input voltage on 5V tolerant pin	$V_{SS} - 0.3$	$V_{DD} + 4.0$	V
	Input voltage on other I/O	$V_{SS} - 0.3$	4.0	V
I_{IO}	Maximum current for GPIO pins	—	25	mA
T_A	Operating temperature range	-40	+85	°C
T_{STG}	Storage temperature range	-55	+150	°C
T_J	Maximum junction temperature	—	125	°C

4.2 Recommended DC characteristics

Table 4. DC operating conditions

Symbol	Parameter	Conditions	Min	Typ	Max	Unit
V_{DD}	Supply voltage	—	2.6	3.3	3.6	V
V_{DDA}	Analog supply voltage	Same as V_{DD}	2.6	3.3	3.6	V
V_{BAT}	Battery supply voltage	—	1.8	—	3.6	V

4.3 Power consumption

The power measurements specified in the tables represent that code with data executing from on-chip Flash with the following specifications.

Table 5. Power consumption characteristics

Symbol	Parameter	Conditions	Min	Typ	Max	Unit
I _{DD}	Supply current (Run mode)	V _{DD} =V _{BAT} =3.3V, HSE=8MHz, System clock=108 MHz, All peripherals enabled	—	45.2	—	mA
		V _{DD} =V _{BAT} =3.3V, HSE=8MHz, System clock =108 MHz, All peripherals disabled	—	36.0	—	mA
		V _{DD} =V _{BAT} =3.3V, HSE=8MHz, System clock =72MHz, All peripherals enabled	—	32.4	—	mA
		V _{DD} =V _{BAT} =3.3V, HSE=8MHz, System Clock =72 MHz, All peripherals disabled	—	26.1	—	mA
	Supply current (Sleep mode)	V _{DD} =V _{BAT} =3.3V, HSE=8MHz, CPU clock off, All peripherals enabled	—	23.2	—	mA
		V _{DD} =V _{BAT} =3.3V, HSE=8MHz, CPU clock off, All peripherals disabled	—	13.9	—	mA
	Supply current (Deep-Sleep mode)	V _{DD} =V _{BAT} =3.3V, All clock off, LSI on, RTC on, All GPIOs analog mode	—	0.65	1.4	mA
	Supply current (Standby mode)	V _{DD} =V _{BAT} =3.3V, LDO off, LSE off, LSI on, RTC on	—	20.5	—	μA
I _{BAT}	Battery supply current (Standby mode)	V _{DD} not available, V _{BAT} =3.3V, LDO off, LSE on, LSI off, RTC on	—	10.1	—	μA
		V _{DD} not available, V _{BAT} =3.3 V, LDO off, LSE off, LSI on, RTC on	—	6.8	—	μA

4.4 EMC characteristics

EMS (electromagnetic susceptibility) includes ESD (Electrostatic discharge, positive and negative) and FTB (Burst of Fast Transient voltage, positive and negative) testing result is given in the following table, based on the EMS levels and classes compliant with IEC 61000 series standard.

Table 6. EMS characteristics

Symbol	Parameter	Conditions	Level/Class
V_{ESD}	Voltage applied to all device pins to induce a functional disturbance	VDD = 3.3 V, TA = +25 °C conforms to IEC 61000-4-2	3A
V_{FTB}	Fast transient voltage burst applied to induce a functional disturbance through 100 pF on V _{DD} and V _{SS} pins	VDD = 3.3 V, TA = +25 °C conforms to IEC 61000-4-4	4A

EMI (Electromagnetic Interference) emission testing result is given in the following table, compliant with IEC 61967-2 standard which specifies the test board and the pin loading.

Table 7. EMI characteristics

Symbol	Parameter	Conditions	Tested frequency band	Conditions			Unit
				56M	72M	108M	
S_{EMI}	Peak level	VDD = 3.3 V, TA = +25 °C, compliant with IEC 61967-2	0.1 to 2 MHz	<0	<0	<0	dB μ V
			2 to 30 MHz	2.3	1.9	0.1	
			30 to 130 MHz	-4.7	-2.1	-3.7	
			130 MHz to 1GHz	-4.7	-2.1	-3.7	

4.5 Power supply supervisor characteristics

Table 8. Power supply supervisor characteristics

Symbol	Parameter	Conditions	Min	Typ	Max	Unit
V_{POR}	Power on reset threshold		2.32	2.40	2.48	V
V_{PDR}	power down reset threshold		2.27	2.35	2.43	V
V_{HYST}	PDR hysteresis		—	0.05	—	V
$T_{RSTTEMP}$	Reset temporization		—	2	—	s

4.6 Electrical sensitivity

The device is strained in order to determine its performance in terms of electrical sensitivity. Electrostatic discharges (ESD) are applied directly to the pins of the sample. Static latch-up (LU) test is based on the two measurement methods.

Table 9. ESD characteristics

Symbol	Parameter	Conditions	Min	Typ	Max	Unit
$V_{ESD(HBM)}$	Electrostatic discharge voltage (human body model)	$T_A=25\text{ }^\circ\text{C}$; JESD22-A114	—	—	3000	V
$V_{ESD(CDM)}$	Electrostatic discharge voltage (charge device model)	$T_A=25\text{ }^\circ\text{C}$; JESD22-C101	—	—	500	V

Table 10. Static latch-up characteristics

Symbol	Parameter	Conditions	Min	Typ	Max	Unit
LU	I-test	$T_A=25\text{ }^\circ\text{C}$; JESD78	—	—	± 100	mA
	V_{supply} over voltage		—	—	5.4	V

4.7 External clock characteristics

Table 11. High speed external clock (HSE) generated from a crystal/ceramic characteristics

Symbol	Parameter	Conditions	Min	Typ	Max	Unit
f_{HSE}	High Speed External oscillator (HSE) frequency	$V_{DD}=3.3V$	3	8	32	MHz
C_{HSE}	Recommended load capacitance on OSC_IN and OSC_OUT	—	—	20	30	pF
R_{FHSE}	Recommended external feedback resistor between XTALIN and XTALOUT	—	—	1	—	M Ω
D_{HSE}	HSE oscillator duty cycle	—	48	50	52	%
I_{DDHSE}	HSE oscillator operating current	$V_{DD}=3.3V$, $T_A=25^\circ\text{C}$	—	1.4	—	μA
t_{SUHSE}	HSE oscillator startup time	$V_{DD}=3.3V$, $T_A=25^\circ\text{C}$	—	2	—	ms

Table 12. Low speed external clock (LSE) generated from a crystal/ceramic characteristics

Symbol	Parameter	Conditions	Min	Typ	Max	Unit
f_{LSE}	Low Speed External oscillator (LSE) frequency	$V_{DD}=V_{BAT}=3.3V$	—	32.768	1000	KHz
C_{LSE}	Recommended load capacitance on OSC32_IN and OSC32_OUT	—	—	—	15	pF
R_{FLSE}	Recommended external feedback resistor between XTAL32IN and XTAL32OUT	—	—	5	—	MΩ
D_{LSE}	LSE oscillator duty cycle	—	48	50	52	%
I_{DDLSE}	LSE oscillator operating current	$V_{DD}=V_{BAT}=3.3V$	—	1.4	—	μA
t_{SULSE}	LSE oscillator startup time	$V_{DD}=V_{BAT}=3.3V$	—	3	—	s

4.8 Internal clock characteristics

Table 13. High speed internal clock (HSI) characteristics

Symbol	Parameter	Conditions	Min	Typ	Max	Unit
f_{HSI}	High Speed Internal Oscillator (HSI) frequency	$V_{DD}=3.3V$	—	8	—	MHz
ACC_{HSI}	HSI oscillator Frequency accuracy, Factory-trimmed	$V_{DD}=3.3V, T_A=-40^{\circ}C \sim +105^{\circ}C$	-2.5	—	+1.5	%
		$V_{DD}=3.3V, T_A=0^{\circ}C \sim +85^{\circ}C$	-1.2	—	+1.2	%
		$V_{DD}=3.3V, T_A=25^{\circ}C$	-1	—	+1	%
D_{HSI}	HSI oscillator duty cycle	$V_{DD}=3.3V, f_{HSI}=8MHz$	48	50	52	%
I_{DDHSI}	HSI oscillator operating current	$V_{DD}=3.3V, f_{HSI}=8MHz$	—	80	100	μA
t_{SUHSI}	HSI oscillator startup time	$V_{DD}=3.3V, f_{HSI}=8MHz$	1	—	2	us

Table 14. Low speed internal clock (LSI) characteristics

Symbol	Parameter	Conditions	Min	Typ	Max	Unit
f_{LSI}	Low Speed Internal oscillator (LSI) frequency	$V_{DD}=V_{BAT}=3.3V, T_A=-40^{\circ}C \sim +85^{\circ}C$	30	40	60	KHz
I_{DDLSI}	LSI oscillator operating current	$V_{DD}=V_{BAT}=3.3V, T_A=25^{\circ}C$	—	1	2	μA
t_{SULSI}	LSI oscillator startup time	$V_{DD}=V_{BAT}=3.3V, T_A=25^{\circ}C$	—	—	80	μs

4.9 PLL characteristics

Table 15. PLL characteristics

Symbol	Parameter	Conditions	Min	Typ	Max	Unit
f_{PLLIN}	PLL input clock frequency		1	8	25	MHz
f_{PLL}	PLL output clock frequency		16	—	108	MHz
t_{LOCK}	PLL lock time		—		100	μ s

4.10 Memory characteristics

Table 16. Flash memory characteristics

Symbol	Parameter	Conditions	Min	Typ	Max	Unit
PE_{CYC}	Number of guaranteed program /erase cycles before failure (Endurance)	$T_A = -40^\circ\text{C} \sim +85^\circ\text{C}$	100	—	—	kcycles
t_{RET}	Data retention time	$T_A = 125^\circ\text{C}$	20	—	—	years
t_{PROG}	Word programming time	$T_A = -40^\circ\text{C} \sim +85^\circ\text{C}$	200	—	400	μ s
t_{ERASE}	Page erase time	$T_A = -40^\circ\text{C} \sim +85^\circ\text{C}$	60	100	450	ms
t_{MERASE}	Mass erase time	$T_A = -40^\circ\text{C} \sim +85^\circ\text{C}$	3.2	—	9.6	s

4.11 GPIO characteristics

Table 17. I/O port characteristics

Symbol	Parameter	Conditions	Min	Typ	Max	Unit
V_{IL}	Standard IO Low level input voltage	$V_{DD} = 2.6\text{V}$	-0.3	—	0.95	V
	5V-tolerant IO Low level input voltage	$V_{DD} = 2.6\text{V}$	-0.3	—	0.9	V
V_{IH}	Standard IO High level input voltage	$V_{DD} = 2.6\text{V}$	1.2	—	4.0	V
	5V-tolerant IO High level input voltage	$V_{DD} = 2.6\text{V}$	1.5	—	5.5	V
V_{OL}	Low level output voltage	$V_{DD} = 2.6\text{V}$	—	—	0.2	V
V_{OH}	High level output voltage	$V_{DD} = 2.6\text{V}$	2.3	—	—	V
R_{PU}	Internal pull-up resistor	$V_{IN} = V_{SS}$	30	40	50	k Ω
R_{PD}	Internal pull-down resistor	$V_{IN} = V_{DD}$	30	40	50	k Ω

4.12 ADC characteristics

Table 18. ADC characteristics

Symbol	Parameter	Conditions	Min	Typ	Max	Unit
V_{DDA}	Operating voltage		2.6	3.3	3.6	V
V_{ADCIN}	ADC input voltage range		0	—	V_{REF+}	V
f_{ADC}	ADC clock		0.6	—	14	MHz
f_s	Sampling rate		—	—	1	MHz
$f_{ADCCONV}$	ADC conversion time	$f_{ADC}=14\text{MHz}$	1	—	18	μs
R_{ADC}	Input sampling switch resistance		—	—	0.5	k Ω
C_{ADC}	Input sampling capacitance	No pin/pad capacitance included	—	32	—	pF
t_{SU}	Startup time		—	—	1	μs

4.13 DAC characteristics

Table 19. DAC characteristics

Symbol	Parameter	Conditions	Min	Typ	Max	Unit
V_{DDA}	Operating voltage		2.6	3.3	3.6	V
V_{DACIN}	DAC input voltage range		0	—	V_{REF+}	V
R_{LOAD}	Load resistance	Resistive load vs. V_{SSA} with buffer ON	5	—	—	k Ω
C_{LOAD}	Load capacitance	No pin/pad capacitance included	—	—	50	pF
DNE	Differential non-linearity error	DAC in 12-bit	—	—	± 3	LSB
INL	Integral non-linearity	DAC in 12-bit	—	—	± 4	LSB
Offset	Offset error	DAC in 12-bit, $V_{REF+} = 3.6\text{ V}$	—	—	± 12	LSB
GE	Gain error	DAC in 12-bit	—	—	± 0.5	%

4.14 I2C characteristics

Table 20. I2C characteristics

Symbol	Parameter	Conditions	Standard mode		Fast mode		Unit
			Min	Max	Min	Max	
f_{SCL}	SCL clock frequency		0	100	0	400	KHz
$t_{SCL(H)}$	SCL clock high time		4.0	—	0.6	—	ns
$t_{SCL(L)}$	SCL clock low time		4.7	—	1.3	—	ns

4.15 SPI characteristics

Table 21. SPI characteristics

Symbol	Parameter	Conditions	Min	Typ	Max	Unit
f_{SCK}	SCK clock frequency		—	—	18	MHz
$t_{SCK(H)}$	SCK clock high time		19	—	—	ns
$t_{SCK(L)}$	SCK clock low time		19	—	—	ns
SPI master mode						
$t_{V(MO)}$	Data output valid time		—	—	25	ns
$t_{H(MO)}$	Data output hold time		2	—	—	ns
$t_{SU(MI)}$	Data input setup time		5	—	—	ns
$t_{H(MI)}$	Data input hold time		5	—	—	ns
SPI slave mode						
$t_{SU(NSS)}$	NSS enable setup time	$f_{PCLK}=54MHz$	74	—	—	ns
$t_{H(NSS)}$	NSS enable hold time	$f_{PCLK}=54MHz$	37	—	—	ns
$t_{A(SO)}$	Data output access time	$f_{PCLK}=54MHz$	0	—	55	ns
$t_{DIS(SO)}$	Data output disable time		3	—	10	ns
$t_{V(SO)}$	Data output valid time		—	—	25	ns
$t_{H(SO)}$	Data output hold time		15	—	—	ns
$t_{SU(SI)}$	Data input setup time		5	—	—	ns
$t_{H(SI)}$	Data input hold time		4	—	—	ns

5 Package information

Figure 7. LQFP package outline

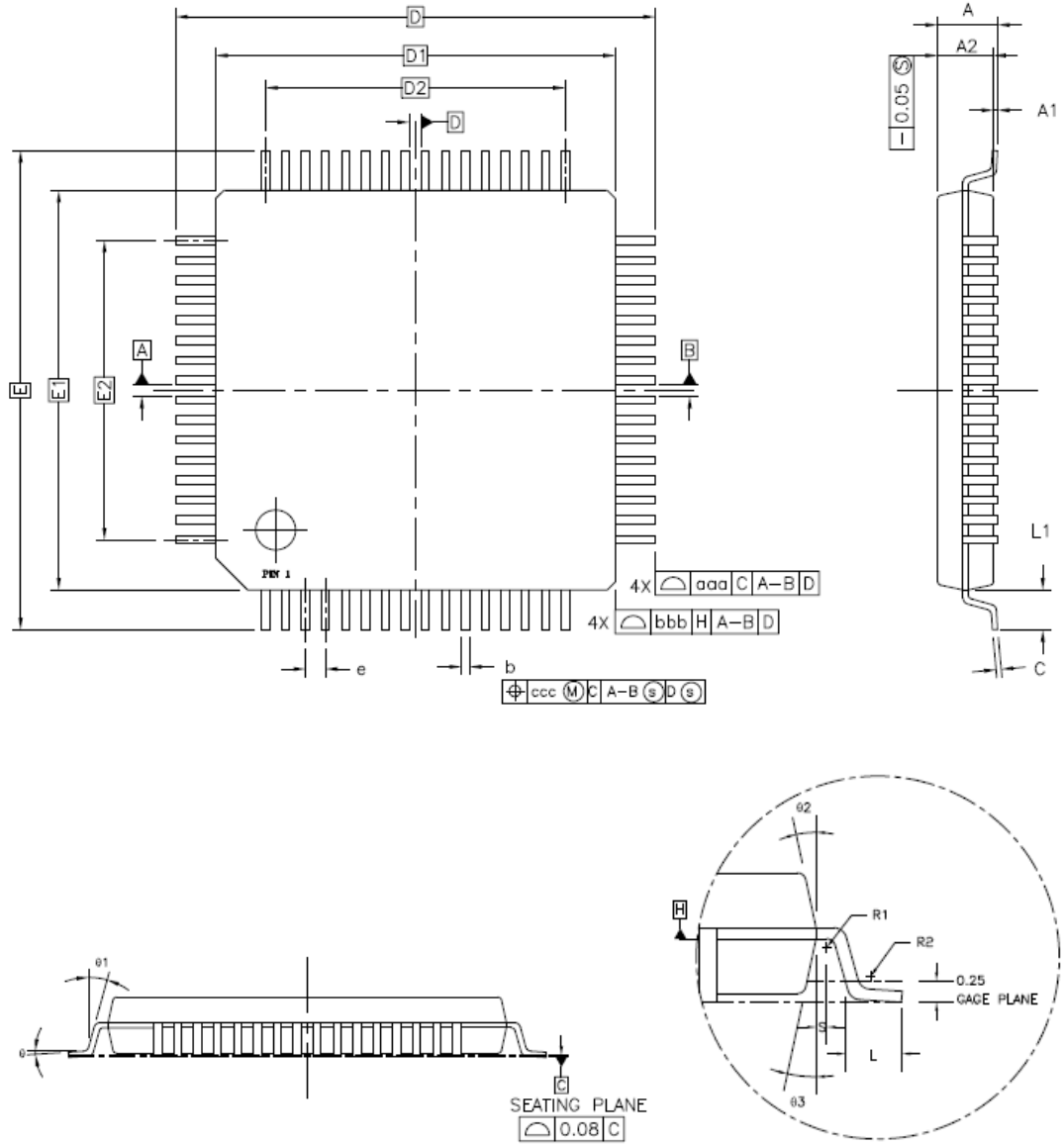

Table 22. LQFP package dimensions

Symbol	LQFP64			LQFP100			LQFP144		
	Min	Typ	Max	Min	Typ	Max	Min	Typ	Max
A	-	-	1.60	-	-	1.60	-	-	1.60
A1	0.05	-	0.15	0.05	-	0.15	0.05	-	0.15
A2	1.35	1.40	1.45	1.35	1.40	1.45	1.35	1.40	1.45
D	-	12.00	-	-	16.00	-	-	22.00	-
D1	-	10.00	-	-	14.00	-	-	20.00	-
E	-	12.00	-	-	16.00	-	-	22.00	-
E1	-	10.00	-	-	14.00	-	-	20.00	-
R1	0.08	-	-	0.08	-	-	0.08	-	-
R2	0.08	-	0.20	0.08	-	0.20	0.08	-	0.20
θ	0°	3.5°	7°	0°	3.5°	7°	0°	3.5°	7°
θ_1	0°	-	-	0°	-	-	0°	-	-
θ_2	11°	12°	13°	11°	12°	13°	11°	12°	13°
θ_3	11°	12°	13°	11°	12°	13°	11°	12°	13°
c	0.09	-	0.20	0.09	-	0.20	0.09	-	0.20
L	0.45	0.60	0.75	0.45	0.60	0.75	0.45	0.60	0.75
L1	-	1.00	-	-	1.00	-	-	1.00	-
S	0.20	-	-	0.20	-	-	0.20	-	-
b	0.17	0.20	0.27	0.17	0.20	0.27	0.17	0.20	0.27
e	-	0.50	-	-	0.50	-	-	0.50	-
D2	-	7.50	-	-	12.00	-	-	17.50	-
E2	-	7.50	-	-	12.00	-	-	17.50	-
aaa	0.20			0.20			0.20		
bbb	0.20			0.20			0.20		
ccc	0.08			0.08			0.08		

(Original dimensions are in millimeters)

6 Ordering Information

Table 23. Part ordering code for GD32F107xx devices

Ordering code	Flash (KB)	Package	Package type	Temperature operating range
GD32F107RBT6	128	LQFP64	Green	Industrial -40°C to +85°C
GD32F107RCT6	256	LQFP64	Green	Industrial -40°C to +85°C
GD32F107RDT6	384	LQFP64	Green	Industrial -40°C to +85°C
GD32F107RET6	512	LQFP64	Green	Industrial -40°C to +85°C
GD32F107RFT6	768	LQFP64	Green	Industrial -40°C to +85°C
GD32F107RGT6	1024	LQFP64	Green	Industrial -40°C to +85°C
GD32F107VBT6	128	LQFP100	Green	Industrial -40°C to +85°C
GD32F107VCT6	256	LQFP100	Green	Industrial -40°C to +85°C
GD32F107VDT6	384	LQFP100	Green	Industrial -40°C to +85°C
GD32F107VET6	512	LQFP100	Green	Industrial -40°C to +85°C
GD32F107VFT6	768	LQFP100	Green	Industrial -40°C to +85°C
GD32F107VGT6	1024	LQFP100	Green	Industrial -40°C to +85°C
GD32F107ZCT6	256	LQFP144	Green	Industrial -40°C to +85°C
GD32F107ZDT6	384	LQFP144	Green	Industrial -40°C to +85°C
GD32F107ZET6	512	LQFP144	Green	Industrial -40°C to +85°C
GD32F107ZFT6	768	LQFP144	Green	Industrial -40°C to +85°C
GD32F107ZGT6	1024	LQFP144	Green	Industrial -40°C to +85°C

7 Revision History

Table 24. Revision history

Revision No.	Description	Date
1.0	Initial Release	Oct.25, 2013
1.1	Characteristics values modified	Nov.10, 2013